



ABL90 FLEX

Instructions for use

From software version 3.1

Contents

1. Introduction

Intended use.....	1
Limitations of use.....	2
About limitations of use.....	2
Measurement of <i>FHbF</i>	2
Operator training requirements.....	2
About this document.....	2
Documentation.....	3
About hazards.....	3
General warning and cautions.....	3
Reference.....	3

2. Getting to know the analyzer

Overview of the analyzer.....	5
Front view.....	5
Side and back view.....	6
Consumables.....	6
To see details about installed consumables.....	7
Is the analyzer ready for use?.....	7
Three important conditions.....	7
Parameter tab colors.....	8
To access the Analyzer status screen.....	8
The Analyzer status screen.....	9
Analyzer status - Traffic light colors.....	9
Messages.....	9
To find and troubleshoot messages in the Analyzer status screen.....	11
Is the analyzer operating on battery power?.....	11
Common tasks.....	12
To log on.....	12
To scan a barcode.....	12
To enter text.....	13
To select/deselect a check button.....	13
To save changes.....	13
Menu.....	14
Menu structure.....	14
Data logs.....	15
About data logs.....	15
Overview of data logs.....	15
To access data logs.....	15

3. Patient sample analysis

- General warnings and cautions..... 17
- Anticoagulants..... 17
- Good results come from good samples..... 18
 - What is a good sample?.....18
 - To get a good sample..... 18
 - To mix a sample on the analyzer.....19
 - Storage recommendations..... 19
- Pre-registration of samples.....20
 - About sample pre-registration..... 20
 - To pre-register a sample.....20
- Analyzing patient samples..... 20
 - General information for obtaining successful patient sample analyses..... 20
 - To analyze a sample from a syringe.....21
 - To analyze a sample from a capillary tube..... 22
 - To analyze a sample from a test tube..... 24
 - To get calculated values for $FShunt$ and $ctO_2(a-v)$ 26
- Entering and editing data in the Patient identification screen..... 26
 - The Patient identification screen.....26
 - To change the report layout in the Patient identification screen..... 27
 - To request patient data automatically when connected to a LIS/HIS system.....27
 - To request patient data using Patient lookup.....27
 - To edit data in the Patient identification screen..... 28
- Patient results..... 28
 - To find a patient result.....28
 - Symbols on patient results..... 28
 - About ranges and critical limits..... 29
 - Status in the Patient results log..... 29
 - To see messages on patient results..... 30
 - To troubleshoot messages on results..... 30
 - To see the acid-base chart for a result..... 30
- Reviewing and editing patient results..... 30
 - To filter data from the Patient results log.....30
 - To see trends in a patient's results..... 31
 - To see the audit trail on a patient result..... 31
 - To add a note to a patient result 31
 - To remove a parameter from a patient result..... 31
 - To show a parameter in a patient result..... 32
 - Approval and rejection of patient results..... 32
 - To approve a patient result.....32
 - To reject a patient result.....32
- Critical limit notification..... 33
 - About Critical limit notification..... 33
 - To enable Critical limit notification..... 33
 - To use Critical limit notification..... 33
 - Pending results log.....33
 - To access the Pending results log..... 34
 - Input fields for the Patient report layout.....34
 - References.....34

4. Replacements and maintenance

- General warnings and cautions..... 35
- To order products for use with your analyzer..... 35
- Replacement intervals for consumables and Inlet Connector Gasket.....35
- Replacements..... 36
- Solution Pack.....36
 - To see the Solution Pack status.....36
 - To replace the Solution Pack.....36
 - To release the Solution Pack manually..... 38
 - Can a Solution Pack be used again?.....38
 - Status logs..... 39
 - To print Solution Pack status logs.....39
 - To export Solution Pack status logs..... 39
- Sensor Cassette..... 39
 - To see the Sensor Cassette status.....39
 - To replace the Sensor Cassette.....39
 - Calibration frequency after a Sensor Cassette replacement40
 - Can a Sensor Cassette be used again?.....41
 - Status logs..... 41
 - To print Sensor Cassette status logs..... 41
 - To export Sensor Cassette status logs.....41
- Thermal printer paper.....42
 - To replace the thermal printer paper.....42
 - Protection of printed data..... 42
- Inlet Gasket Holder..... 43
 - To replace the Inlet Gasket Holder.....43
- Inlet Probe..... 44
 - To replace the Inlet Probe..... 44
- Inlet Connector Gasket..... 48
 - To replace the Inlet Connector Gasket..... 48
- Inlet Module..... 50
 - To replace the Inlet Module..... 50
- Maintenance..... 52
- Cleaning..... 52
 - Cleaning - when is it necessary?..... 52
 - To clean the inlet gasket..... 52
 - To clean the Inlet Module..... 53
 - To clean the touch screen..... 56
 - To clean the analyzer exterior.....56
- Disinfecting..... 56
 - Disinfection - when is it necessary?..... 56
 - To disinfect the touch screen 57
 - To disinfect the analyzer exterior..... 57
 - To disinfect the fluid transport system..... 57
- Battery..... 57
 - To recharge the analyzer battery.....57
 - To install and service the battery.....57
- Disposal.....58
 - To dispose of the analyzer.....58

Inlet Clip..... 58

 Inlet Clip - when is it necessary to use one?..... 58

 To put an Inlet Clip on the Inlet Gasket Holder..... 58

 To remove the Inlet Clip from the Inlet Gasket Holder..... 60

Connecting peripherals..... 60

 To connect a USB external keyboard / mouse..... 60

 To connect a non-USB (PS/2) external keyboard or mouse..... 60

 To connect an external barcode reader.....61

 To connect the analyzer to a network.....61

 Reference..... 61

5. Quality control

 Overview of quality control management..... 63

 To find the status of QC measurements.....63

 Symbols that show the status of QCs.....63

Automatic quality control management.....63

 About automatic quality control management..... 63

 About system checks.....64

 Overview of automatic quality management..... 64

Built-in QC.....65

 About built-in QC measurements.....65

 Built-in QC measurement frequency..... 65

 To request an unscheduled built-in QC measurement..... 66

Built-in QC results..... 66

Quality control management done by operators..... 67

 Quality control management that can be done by operators.....67

Ampoule-based QC measurements.....68

 QC solutions for ampoule-based measurements..... 68

 How to get good ampoule-based QC measurement results..... 68

 To prepare a Radiometer QC ampoule for use..... 69

 To do an ampoule-based QC measurement.....71

 To edit QC identification data.....72

Ampoule-based QC results..... 72

Calibration verification.....74

 About calibration verification..... 74

 Frequency of calibration verification..... 74

Stage 1 - Analyzing different levels of control solution.....75

 To prepare a Radiometer calibration-verification ampoule for use.....75

 To do a calibration-verification measurement..... 76

Stage 2 - Using results to verify reportable ranges.....77

 To find a calibration-verification measurement result..... 77

 Symbols on calibration-verification measurement results.....78

 To temperature correct calibration-verification results based on Range+ QUALICHECK measurements..... 78

 To use temperature-corrected calibration-verification results.....79

Stage 3 - Changing reportable ranges.....79

 To change the reportable range of parameters..... 79

Reviewing QC statistics..... 79

 To find and print QC statistics.....79

 QC plots..... 80

- To find a QC plot.....81
- To filter data from the Quality control log..... 81
- To see trends in QC results.....81
- WDC file export.....81
 - About WDC..... 81
 - To export WDC files.....82
- Analyzing QC solutions in other modes.....82
 - About analyzing QC solutions in other modes.....82
 - To temperature correct results based on QUALICHECK5+ solutions..... 82

6. Calibration

- Calibrations - automatic and manual..... 85
- Identification of calibrations in screens..... 85
- Manual calibration of the oximetry parameters.....85
- Frequency of automatic calibrations.....85
- To find the status of calibrations..... 86
- Symbols that show the calibration status..... 86
- Automatic calibrations.....87
 - To request an unscheduled calibration from the Analyzer status screen..... 87
 - To request an unscheduled calibration from the menu.....87
- Manual tHb calibrations.....87
 - To do a tHb calibration.....87
- Calibration results..... 89
 - To find a calibration result.....89
 - Identification of calibrations in the Calibration log screen.....89
 - Understanding calibration results..... 90
 - To see messages on a calibration result..... 90
 - To troubleshoot messages on results..... 90
- Reviewing calibration results.....90
 - To filter data from the Calibration log.....90
 - To see trends in calibration results..... 91
 - Status in the Calibration log screen..... 91

7. Troubleshooting

- Troubleshooting - when is it necessary?..... 93
- About guided troubleshooting.....93
- To get out of Operator Action Needed mode.....93
- To get out of Troubleshooting needed mode.....93
- To get out of Intervention Required mode..... 93
- Troubleshooting modes - causes..... 93
- To find and troubleshoot messages in the Analyzer status screen..... 94
- To flush the fluid transport system..... 95
- Operator actions requested in analyzer messages.....98
 - To request a tubing refill..... 98
 - To request a liquid sensor adjustment.....98
 - To request a pump calibration.....98
 - To request a rinse..... 98
- Troubleshooting Analyzer messages.....98
 - To troubleshoot Analyzer messages..... 98

- Analyzer messages..... 98
- Activity log..... 134
 - About the Activity log..... 134
 - To troubleshoot messages in the Activity log..... 134
 - To see activities in the Activity log..... 134
 - To add a message to the Activity log..... 134
 - To filter activities from the Activity log..... 134
- Analyzer service..... 134
 - For service..... 134
 - To find the installation number (serial number) of the analyzer..... 135
 - To find the version of software installed..... 135

8. Shutting down, moving and restarting the analyzer

- Shutdown..... 137
- Temporary shutdown of the analyzer..... 137
 - When to do a temporary shutdown..... 137
 - To do a temporary shutdown..... 137
- Long-term shutdown of the analyzer..... 137
 - When to do a long-term shutdown..... 137
 - To do a long-term shutdown 138
- Storing the analyzer..... 140
 - To store the analyzer..... 140
- Moving the analyzer..... 140
 - To move an analyzer that has a charged battery..... 140
 - To move an analyzer that does not have a battery..... 140
- Restarting the analyzer..... 140
 - To restart the analyzer after a temporary shutdown..... 140
 - To restart the analyzer after a long-term shutdown..... 141

9. Setup

- Setup menu structure..... 143
 - To print setups..... 144
- Managing operators..... 144
 - To select the logon procedure..... 144
 - Access profiles..... 144
 - To edit an access profile..... 144
 - Anonymous use..... 145
 - To set up anonymous use..... 145
 - Default operators..... 145
 - To add an operator..... 145
 - To remove an operator..... 146
 - To set a logoff time for all operators..... 147
 - Centralized user management..... 147
 - To set up centralized user management..... 147
- Managing patient profiles..... 148
 - Patient profiles log..... 148
 - To see the data saved in a patient profile..... 148
 - To find a patient profile..... 148
 - To edit a patient profile..... 148

- To add a new patient profile..... 148
- To delete a patient profile.....148
- Analyzer operations.....149
 - To lock the analyzer..... 149
 - To unlock the analyzer..... 149
 - To lock/unlock parameters for measurement..... 149
 - To show a message on the analyzer screen..... 149
- Sample counter..... 150
 - To see an overview of measurements and tests done on the analyzer..... 150
 - Sample counter..... 150
 - To reset the counters in the User column..... 150
- Analyzer settings..... 150
 - To set up corrective actions on system messages..... 150
 - To enable data to be scanned from barcodes..... 151
 - To create a heading for printed data..... 151
 - To enable the screen saver..... 151
 - To set the time and date..... 151
 - To set the acoustic signals..... 152
 - To mute all acoustic signals..... 152
 - To change the screen language..... 152
 - To select a regional setting..... 152
 - To set the barometric pressure..... 153
 - To log all measurement activities..... 153
- Analysis setup..... 153
 - Analysis modes..... 153
 - Syringe modes..... 153
 - To edit a syringe mode.....153
 - To create a new syringe mode.....154
 - To remove a measurement mode..... 155
 - To select a default measurement mode..... 155
 - To select a specific patient report layout for an analysis mode..... 156
 - To set up a calibration-verification mode..... 156
 - To set up an ampoule QC mode.....156
 - Capillary modes..... 157
 - To edit a capillary mode..... 157
 - Proficiency test modes..... 157
 - To set up a proficiency test mode..... 158
 - Ranges and critical limits..... 158
 - About ranges and critical limits..... 158
 - About reference ranges..... 159
 - Reference range of measured parameters..... 159
 - Reference ranges for neonatal ctBil..... 159
 - About critical limits..... 160
 - To set the limits for patient age groups..... 160
 - To set up reference ranges and critical limits..... 160
 - About reportable ranges..... 161
 - To set up reportable ranges..... 161
 - About range of indication..... 161
 - Sample pre-registration..... 161
 - About sample pre-registration..... 161
 - To set up sample pre-registration..... 162

Sample age evaluation.....	162
About sample age evaluation.....	162
Maximum sample age.....	162
To set a maximum sample age.....	162
Max sample age.....	163
Patient report layouts.....	163
About patient report layouts.....	163
To create a patient report layout.....	163
To change a patient result layout.....	165
To create extra items for use in patient report layouts.....	166
To select a patient report layout as default.....	166
To automatically change the temperature units.....	167
To edit a patient report layout.....	167
To create a patient report layout for F Shunt and $ctO_2(a-\bar{v})$	168
Patient result settings.....	168
To set up automatic printing of acid-base charts.....	168
Approval and rejection of patient results.....	169
To enable patient result approval/rejection.....	169
Parameter settings.....	169
To show the parameter bar.....	169
To hide the parameter bar.....	169
To enable/disable a parameter.....	169
To set up measuring units for parameters.....	170
To repress a parameter.....	170
To suppress out-of-range results.....	170
To fix the number of decimals used in blood-gas results.....	170
To enable HbF corrections.....	171
To enable the estimation of derived parameters.....	171
Editing the slope and offset of a parameter.....	172
Operator-defined corrections (offset and slope).....	172
Recommendations about samples to use.....	173
Limits for slope and offset values.....	173
To edit the offset and slope for a parameter.....	174
Calibration settings.....	175
Details about calibration frequency.....	175
To edit the calibration schedule.....	175
To link the built-in QC schedule to the calibration schedule.....	176
To set up corrective actions for overdue scheduled calibrations.....	177
Quality control.....	177
Glossary of quality control terms.....	177
Registration of QC solutions.....	178
Why is it necessary to register QC solutions?.....	178
About registration of QC solutions.....	178
To register a Radiometer QC solution for ampoule-based QC measurements.....	178
Data saved during registration of Radiometer QC solutions.....	178
To register a non-Radiometer QC solution.....	179
Data saved during registration of non-Radiometer QC solutions.....	180
Quality control solutions.....	180
To set up the temperature field for QC measurements.....	180
Scheduled QC measurements.....	181
To schedule ampoule-based QC measurements.....	181

To edit the schedule for ampoule-based QC measurements.....	181
Built-in QC measurement frequency.....	182
To edit the schedule for built-in QC measurements.....	182
To request ampoule-based QC measurements after replacements.....	184
Corrective actions on QC results.....	184
To set up corrective action for errors in QC results.....	184
To set up corrective actions for overdue scheduled QC measurements.....	185
To apply operator-defined corrections to QC results.....	185
To set up corrective action for errors in built-in QC measurements.....	185
QC statistics.....	186
To set up automatic print of built-in QC statistics.....	186
Statistical factor.....	186
To set the statistical factor.....	186
Westgard Rules.....	186
About Westgard Rules.....	186
Types of Westgard Rule	186
Description of the lines used in Westgard rule illustrations.....	186
Westgard rules and corrective actions.....	187
To set up and enable Westgard Rules.....	188
To disable/enable Westgard rules.....	189
RiLiBÄK rules.....	189
About RiLiBÄK rules.....	189
To add a new RiLiBÄK rule.....	189
To apply all RiLiBÄK rules.....	190
To edit a RiLiBÄK rule.....	190
To remove a RiLiBÄK rule.....	191
Analyzer-specific control ranges.....	191
About analyzer-specific control ranges.....	191
How to establish analyzer-specific control ranges.....	191
Stage 1: To do 20 ampoule-based QC measurements.....	192
Stage 2: To enable the use of fixed standard deviations.....	192
Stage 3: To use the analyzer to change control ranges to analyzer-specific control ranges.....	192
To manually change control ranges to analyzer-specific control ranges.....	193
Maintenance setup.....	194
About mandatory and operator-defined activities.....	194
Mandatory maintenance activities.....	194
Other activities.....	194
To schedule other activities.....	195
To set up corrective action for overdue Other activities.....	195
Operator-defined activities.....	196
Operator activities.....	196
To set up an operator activity.....	196
To set up corrective action for pending operator activities.....	196
To delete an operator activity.....	196
Maintenance planning.....	196
To plan maintenance activities.....	196
Replacement warnings.....	197
To set up replacement warnings.....	197
Note fields.....	197
To create standard texts for use in Note fields.....	197
To edit standard texts for use in Note fields.....	197

- To delete standard texts for use in Note fields..... 198
- Communications..... 198
 - To set up a LIS/HIS connection..... 198
 - To set up a AQUIRE/RADIANCE connection..... 198
 - Patient data from a LIS/HIS or AQUIRE/RADIANCE system..... 199
 - To set up automatic requests for patient data..... 199
 - To set up automatic transmission of data to a system..... 199
 - To enable manual patient data requests using Patient lookup..... 199
 - To access the RADIANCE system from the analyzer..... 200
 - To set up a QA Portal connection..... 200
- Printers..... 200
 - To set up automatic printing..... 200
 - To install an external printer for the analyzer..... 201
 - To edit the name of a printer..... 201
- Data logs and archives..... 201
 - About data logs and archived data logs..... 201
 - To set up automatic archiving..... 202
 - File format of exported data logs and archived data logs..... 202
 - To export data logs..... 202
 - To export data from Archived data logs..... 203
 - To create disc space by exporting and deleting archives..... 203
 - To import archived data logs..... 203
- Data backup and restoration..... 204
 - Backup..... 204
 - Destinations for backup data..... 204
 - To schedule automatic backups..... 204
 - To do a manual backup..... 204
 - To restore data from a backup..... 204
- Saving and loading setups..... 205
 - To save the setup..... 205
 - To load a setup..... 205
 - To restore Radiometer default settings..... 205
- Radiometer default settings..... 206
 - Operators and profiles - default settings..... 206
 - Alarm sound (acoustic signal) settings for events - default settings..... 207
 - Language - default setting..... 207
 - Analysis setup - default settings..... 207
 - Parameters - default settings..... 209
 - Measurement units - default settings..... 209
 - Calibration schedule - default settings..... 211
 - Quality control setups - default settings..... 211
 - Replacement setups - default settings..... 211
 - Communication setup - default settings..... 212
 - User-defined patient data items - default settings..... 212
 - Corrective actions - default settings..... 213
 - Miscellaneous setup - default settings..... 213
 - Printer setup - default settings..... 214
 - Automatic printing - default settings..... 214
 - Automatic archiving - default settings..... 214
 - Automatic backup - default setting..... 214
 - Setups with no default settings..... 214
 - References..... 215

10. Performance characteristics

Measured parameters - definitions.....	217
About performance characteristics.....	218
Overview of performance characteristics.....	218
Uncertainty in performance characteristics.....	218
To convert an uncertainty at a 68 % confidence level.....	219
Bias.....	219
Repeatability and reproducibility.....	219
Coefficient of variation (CV %).....	220
Confidence intervals.....	220
Total analytical error.....	220
About performance tests.....	221
Test conditions.....	221
Reference methods/materials.....	222
Performance test results.....	223
Rounding rules.....	223
pH performance test results.....	223
pCO ₂ performance test results.....	224
pO ₂ performance test results.....	224
cK ⁺ performance test results.....	225
cNa ⁺ performance test results.....	225
cCl ⁻ performance test results.....	226
cCa ²⁺ performance test results.....	226
cGlu performance test results.....	227
pO ₂ levels - how they affect cGlu results.....	229
cLac performance test results.....	229
ctHb performance test results.....	230
sO ₂ performance test results.....	231
FO ₂ Hb performance test results.....	232
FCOHb performance test results.....	232
FMetHb performance test results.....	233
FHHb performance test results.....	234
FHbF performance test results.....	235
ctBil* performance test results.....	235
Linearity study - study design.....	236
Linearity study.....	236
Linearity study - results.....	236
Graphical presentation of test results and first order models.....	237
Interference test results.....	242
Interference tests.....	242
pH/blood gas.....	242
Electrolytes.....	243
Metabolites.....	247
Oximetry parameters.....	251
ctBil sensitivity for MCHC variations.....	257
Alternative presentation of interference results.....	259
pH/blood gas (alternative presentation).....	259
Electrolytes (alternative presentation).....	259
Metabolites (alternative presentation).....	261
Oximetry parameters (alternative presentation).....	264

External test results.....	269
Study design - precision/reproducibility.....	269
ABL90 FLEX precision - syringe study - site 1.....	270
ABL90 FLEX precision - syringe study - site 3.....	272
ABL90 FLEX precision - syringe study - site 5.....	274
ABL90 FLEX precision - syringe study - pooled data.....	276
ABL90 FLEX Precision - capillary study - site 1.....	278
ABL90 FLEX precision - capillary study - site 3.....	280
ABL90 FLEX precision - capillary study - site 5.....	283
ABL90 FLEX precision - capillary study - pooled data.....	285
Method comparison studies with predicate devices.....	287
ABL90 FLEX method comparison study results - syringe mode - site 1.....	287
ABL90 FLEX method comparison study results - syringe mode - site 2.....	288
ABL90 FLEX method comparison study results - syringe mode - site 3.....	289
ABL90 FLEX method comparison study results - syringe mode - pooled data.....	290
Graphical presentation of POC comparison test results - syringe mode.....	291
ABL90 FLEX method comparison study results - capillary mode - site 1.....	297
ABL90 FLEX method comparison study results - capillary mode - site 2.....	298
ABL90 FLEX method comparison study results - capillary mode - site 3.....	299
ABL90 FLEX method comparison study results - capillary mode - pooled data.....	300
Graphical presentation of POC comparison test results - capillary mode.....	301
Traceability.....	307
Traceability to the primary standards at Radiometer.....	307
pH traceability.....	307
pCO ₂ and pO ₂ traceability.....	308
cK ⁺ and cNa ⁺ traceability.....	308
cCa ²⁺ traceability.....	308
cCl ⁻ traceability.....	308
cGlu traceability.....	309
cLac traceability.....	309
ctHb traceability.....	309
Saturation - sO ₂ = 100 % - traceability.....	309
Saturation - sO ₂ = 0 % - traceability.....	309
FCO _{Hb} - normal value - traceability.....	309
FCO _{Hb} - 100 % - traceability.....	310
FMetHb traceability.....	310
FHbF traceability.....	310
Hct traceability.....	310
ctBil* traceability	310
References.....	311

11. Derived and input parameters

Parameter types.....	313
Parameter symbols.....	313
Input parameters – definitions and acceptable values.....	313
Derived parameters.....	314
Default values of parameters.....	315
Definitions of derived parameters.....	316
Acid-base derived parameters – definitions.....	316
Oximetry derived parameters – definitions.....	317
Oxygen derived parameters - definitions.....	317

Electrolyte derived parameters – definitions.....	319
Data necessary to derive electrolyte parameters.....	319
Calculation of derived parameters.....	319
Sample type.....	319
Units and symbols used in equations.....	320
Equations.....	320
Equations for acid-base parameters.....	320
pH(T) - equation 1.....	320
cH ⁺ (T) - equation 2.....	320
pCO ₂ (T) - equation 3.....	321
cHCO ₃ ⁻ (P) - equation 4.....	321
cBase(B) - equation 5.....	321
cBase(B,ox) - equation 6.....	321
cBase(Ecf) - equation 7.....	321
cBase(Ecf,ox) - equation 8.....	321
cHCO ₃ ⁻ (P,st) - equation 9.....	322
ctCO ₂ (P) - equation 10.....	322
ctCO ₂ (B) - equation 11.....	322
pH(st) - equation 12.....	322
Equations for electrolyte parameters.....	322
Anion Gap, K ⁺ equation 43.....	322
Anion Gap - equation 44.....	323
cCa ²⁺ (7.4) - equation 45.....	323
Equations 46 and 47.....	323
mOsm - equation 48.....	323
Equations for oxygen parameters.....	323
pO ₂ (T) - equation 14.....	323
pO ₂ (A) - equation 15.....	324
pO ₂ (A,T) - equation 16.....	324
pO ₂ (a)/FO ₂ (I) - equation 17.....	324
pO ₂ (a,T)/ FO ₂ (I) - equation 18.....	324
p50 - equation 19.....	324
p50(T) - equation 20.....	325
p50(st) - equation 21.....	325
pO ₂ (A-a) - equation 22.....	326
pO ₂ (A-a,T) - equation 23.....	326
pO ₂ (a/A) - equation 24.....	326
pO ₂ (a/A,T) - equation 25.....	326
pO ₂ (x) or p _x - equation 26.....	326
pO ₂ (x,T) - equation 50.....	327
ctO ₂ - equation 27.....	327
ctO ₂ (a- \bar{v}) - equation 28.....	328
BO ₂ - equation 29.....	328
ctO ₂ (x) or c _x - equation 30.....	328
$\dot{D}O_2$ - equation 31.....	328
\dot{Q}_t - equation 32.....	329
$\dot{V}O_2$ - equation 33.....	329
FShunt - equation 34.....	329
FShunt(T) - equation 35.....	330
RI - equation 36.....	331
RI(T) - equation 37.....	331

Q_x - equation 38.....	331
$V(B)$ - equation 42.....	332
$VCO_2/V(\text{dry air})$ - equation 51.....	332
$VO_2/V(\text{dry air})$ - equation 52.....	332
Equations for oximetry parameters.....	332
$FHHb$ - equation 41.....	332
FO_2Hb - equation 40.....	332
sO_2 - equation 39.....	332
Hct - equation 13.....	333
$FHbF$ - equation 49.....	333
Converting results to other units.....	334
Oxyhemoglobin dissociation curve.....	335
ODC equations.....	335
The ODC reference position.....	336
The ODC displacement.....	336
The actual ODC position.....	337
To determine the actual displacement.....	338
Coordinates on the ODC.....	339
References.....	340

12. Principles of operation

General construction.....	341
Sensors.....	341
General measurement principles.....	341
Introduction.....	341
Activity vs. concentration.....	342
Fluid transport system.....	342
Measurement process.....	344
Rinse process.....	344
Calibration.....	344
Definition.....	344
Frequency.....	344
Calibration solutions.....	344
The calibration equation.....	345
About the calibration equation.....	345
Plotting a calibration line.....	345
Sensitivity, status and drift.....	345
Sensitivity.....	345
Status.....	347
Drift.....	347
Reference electrode.....	347
Background information - reference electrode.....	347
Purpose.....	347
Fixed potential.....	347
Use.....	348
Construction - reference electrode.....	348
Construction.....	348
pH and electrolyte sensors.....	348
Construction - pH and electrolyte sensors.....	348
Construction.....	348

Measurement principles - pH and electrolyte sensors.....	349
Potentiometric measurement principle.....	349
Electrode chain.....	349
Electrode chain potential.....	350
Unknown potential.....	350
Ion-sensitive membrane.....	350
Nernst equation.....	350
Activity and concentration.....	351
Calibration - pH and electrolyte sensors.....	351
Calibrations of pH and electrolyte sensors.....	351
Calculation of pH and electrolytes sensitivity.....	351
Measurement - pH and electrolyte sensors.....	351
Calculation of pH and electrolyte values.....	351
Sensor response stability.....	352
<i>pCO₂ sensor.....</i>	<i>352</i>
Construction - <i>pCO₂ sensor.....</i>	<i>352</i>
Construction.....	<i>352</i>
Measurement principle - <i>pCO₂ sensor.....</i>	<i>353</i>
Electrode chain.....	<i>353</i>
Electrode chain potential.....	<i>353</i>
Measurement process in the <i>pCO₂ sensor.....</i>	<i>353</i>
Calibration - <i>pCO₂ sensor.....</i>	<i>354</i>
Calibrations of the <i>pCO₂ sensor</i>	<i>354</i>
Calibration levels.....	<i>354</i>
Calculation of <i>pCO₂ sensitivity.....</i>	<i>354</i>
Measurement - <i>pCO₂ sensor.....</i>	<i>355</i>
Calculation of <i>pCO₂ values.....</i>	<i>355</i>
Sensor response stability.....	<i>355</i>
<i>pO₂ sensor.....</i>	<i>355</i>
Measurement principle - <i>pO₂ sensor.....</i>	<i>355</i>
Optical system for <i>pO₂.....</i>	<i>355</i>
Measurement sequence.....	<i>356</i>
Calculations.....	<i>356</i>
Calibration - <i>pO₂ sensor.....</i>	<i>356</i>
Overview of <i>pO₂ calibrations.....</i>	<i>356</i>
Sensitivity.....	<i>356</i>
Status.....	<i>357</i>
Measurement - <i>pO₂ sensor.....</i>	<i>357</i>
Calculation of <i>pO₂ values.....</i>	<i>357</i>
<i>Metabolite sensors.....</i>	<i>358</i>
Construction - metabolite sensors.....	358
Construction.....	358
Zero current.....	358
Calibration - metabolite sensors.....	359
Calculation of sensitivity.....	359
Measurement - metabolite sensors.....	359
Calculation of metabolite values.....	359
Sensor response stability of the metabolite sensors.....	359
Measurement principle - metabolite sensors.....	360
Amperometric measurement principle.....	360
Electrode chain.....	360

Measurement process..... 360

ctHb and derivates..... 361

 Description of the optical system..... 361

 Measured parameters..... 361

 Construction..... 362

 Measurement cycle..... 362

 Lambert-Beer's law..... 363

 Absorbance..... 363

 Total absorbance..... 363

 Continuous spectrum..... 364

 Spectrum example..... 364

 Determining concentrations..... 364

 Matrix of constants..... 364

 Calibration of the optical system..... 365

 Calibration materials..... 365

 Zero point..... 365

 Cuvette path length..... 365

 Correcting for interferences..... 365

 HbF versus HbA..... 365

 Deviation of results..... 366

 Detecting HbF..... 366

 Correcting for HbF..... 366

 Repressing spectra..... 366

 Residual spectrum..... 366

 Measurement and corrections..... 367

 Calculation of the values of the oximetry parameters..... 367

 Calculation of bilirubin* values..... 367

 Restrictions..... 368

 Corrections for ctHb..... 369

 Corrections for ctBil*..... 369

 References..... 369

13. Specifications

Analyzer specifications..... 371

 Ranges of indication and reportable ranges..... 371

 Measurement precision within specified ranges..... 372

 Product specifications..... 376

 Environmental specifications..... 378

 Power-supply cords..... 380

 Analytical sensitivity – ctBil*..... 380

Consumables specifications..... 380

 Solution Pack..... 380

 Intended use of the Solution Pack..... 380

 Solution Pack specifications..... 380

 Sensor Cassette..... 382

 Intended use of the Sensor Cassette..... 382

 Sensor Cassette specifications..... 382

14. Graphical symbols

Explanation of graphical symbols/icons..... 383

15. Ordering information

Solution Packs - code numbers..... 385
 Sensor Cassettes - code numbers.....385
 Spare parts and accessories - code numbers.....385
 Quality control products - code numbers..... 386
 Recommended Radiometer sampling devices - code numbers.....387
 Power-supply cords - code numbers..... 388

16. Legal information

Patents and trademarks.....389
 Patents..... 389
 Trademarks..... 389
 Legal notices.....389
 System performance..... 389
 Third-party software and trademarks..... 389
 Warranties and disclaimer..... 389
 Confidentiality..... 390
 Changes..... 390
 End-user license agreement with Microsoft..... 390

Index 393

Intended use

The ABL90 FLEX analyzer is an in vitro diagnostic, portable, automated analyzer that quantitatively measures, pH, blood gases, electrolytes, glucose, lactate and oximetry in heparinized whole blood, and neonatal bilirubin in heparinized capillary whole blood.

The ABL90 FLEX analyzer is intended for use by trained technologists, nurses, physicians and therapists.

It is intended for use in a laboratory environment, near patient or point-of-care setting.

These tests are only performed under a physician's order.

Bilirubin measurements on the ABL90 FLEX analyzer are intended to aid in assessing the risk of kernicterus in neonates.

In the table below the measured parameters are shown:

Parameter group	Parameter
pH/blood gas:	pH (acidity)
	$p\text{CO}_2$ (carbon dioxide tension)
	$p\text{O}_2$ (oxygen tension)
Oximetry:	ctHb (total hemoglobin concentration)
	$s\text{O}_2$ (oxygen saturation)
	$F\text{O}_2\text{Hb}$ (fraction of oxyhemoglobin in total hemoglobin)
	$F\text{COHb}$ (fraction of carboxyhemoglobin in total hemoglobin)
	$F\text{HHb}$ (fraction of deoxyhemoglobin in total hemoglobin)
	$F\text{MetHb}$ (fraction of methemoglobin in total hemoglobin)
	$F\text{HbF}$ (fraction of fetal hemoglobin)
Electrolytes:	$c\text{K}^+$ (potassium ion concentration)
	$c\text{Na}^+$ (sodium ion concentration)
	$c\text{Ca}^{2+}$ (calcium ion concentration)
	$c\text{Cl}^-$ (chloride ion concentration)
Metabolites:	$c\text{Glu}$ (D-glucose concentration)
	$c\text{Lac}$ (L(+)-lactate concentration)
	ctBil* (concentration of total neonatal bilirubin in plasma)

*Bilirubin can only be measured on neonatal samples. This parameter is only available in the Neonate blood analysis 65 μL mode.

Limitations of use

About limitations of use

⚠ CAUTION – ctBil results

ctBil results are only valid for neonatal bilirubin analysis.

Note: Only analyze heparinized and electrolyte-balanced human whole blood samples or dedicated quality control material. If you analyze other sample types, you risk damage to the analyzer and incorrect results on subsequent samples.

No tests on animal blood have been done. Animal blood is different from human blood and the composition of the blood can be different within the same species.

Related information

Interference tests, page 242

Measurement of FHbF

The uncertainty in FHbF measurements exceeds the level that is necessary to measure normal HbF levels in the adult reference range (0-1 %). The analyzer can measure FHbF hemoglobin in all types of sample, but the analyzer must be set up to apply an HbF correction to the results.

Related information

To enable HbF corrections, page 171

Operator training requirements

Operators must have received hands-on training in the procedures and functions that are relevant for their field of work and that are described in this Instructions for use. Operators must have been trained in the procedures and functions until they can do them successfully.

⚠ WARNING – Risk of incorrect medical treatment

Failure to select the correct measurement mode can cause incorrect results and incorrect medical treatment. Operators must be trained to do the patient sample analysis correctly.

⚠ WARNING – Risk of delayed medical treatment

Failure to analyze patient samples correctly may require a new sample to be analyzed, which can delay medical treatment. Operators must be trained to do the patient sample analysis correctly.

⚠ WARNING – Risk of infection

Failure to analyze patient samples correctly can expose operators to potentially infectious blood. Operators must be trained to do the patient sample analysis correctly.

About this document

This document tells you what the analyzer can do and how to use it. The analyzer has a default set up that can be customized. Some topics in this document may therefore not be relevant to your analyzer.



Documentation

Note: The documents in the table give instructions for the safe and proper operation of the analyzer. Radiometer does not accept warranty claims or product liability if operators do not follow these instructions.

Document	Description
Instructions for use	How to install and set up the analyzer, instructions for daily use and reference information
Inserts	Instructions and information about consumables supplied for use with the analyzer

About hazards

A hazard symbol shows which instructions an operator must obey to prevent risk to persons or equipment. There are 2 types of hazard.

Hazard type	Hazard symbol	Risk
WARNING		Death or injury to persons
CAUTION		Equipment damage

General warning and cautions

 **WARNING – Risk of infection**

Only let authorized personnel collect and work with blood samples. Make sure to wear gloves.

 **WARNING – Risk of electric shock**

Make sure the analyzer is a minimum of 1.5 m from patient beds.

 **WARNING – Risk of infection**

Dispose and handle all used sampling devices, quality control (QC) ampoules, Solution Packs, Sensor Cassettes, Inlet Probes, Inlet Gasket Holders, Inlet Connector Gaskets and Inlet Modules as biohazardous waste [1]. Follow your local regulations.

Reference

1. Clinical laboratory waste management. CLSI/NCCLS document GP5-A2, Clinical Laboratory Standards Institute, 940 West Valley Road, Suite 1400, Wayne, Pennsylvania 19087-1898 USA.

Getting to know the analyzer

2

Overview of the analyzer

Front view

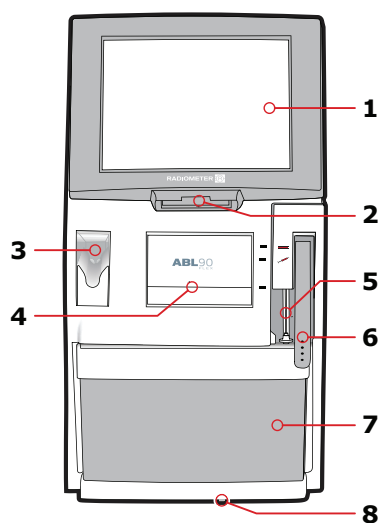

- | | |
|--|----------------------------------|
| 1 Touch screen | 5 Inlet Gasket Holder |
| 2 Barcode reader | 6 Inlet handle |
| 3 Sample mixer (for <i>safePICO</i> samplers) | 7 Solution Pack |
| 4 Compartment for the Sensor Cassette | 8 Battery indicator light |

Side and back view

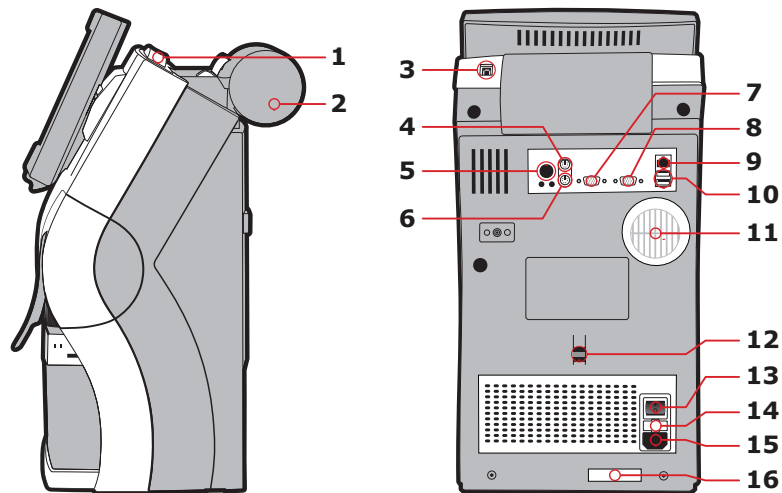

- | | |
|---------------------------------|---|
| 1 Handle | 9 Network cable port |
| 2 Thermal printer | 10 USB ports |
| 3 USB port | 11 Ventilator grid |
| 4 Mouse port | 12 Latch for manual release of a Solution Pack |
| 5 Standby button | 13 Power switch ON (I) and OFF (O) |
| 6 External keyboard port | 14 Mains power fuse |
| 7 External monitor port | 15 Mains power socket |
| 8 COM port | 16 Serial number |

Consumables

Consumables are parts of the analyzer. The consumables have to be replaced at different times. With the exception of the printer paper, the analyzer tells you when consumables must be replaced.

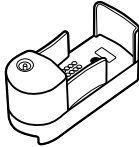
Consumables	Description
 <p>Sensor Cassette</p>	Contains sensors for the tests (except for the oximetry and bilirubin tests)

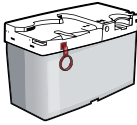
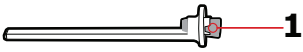
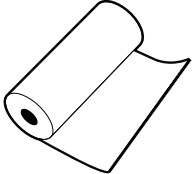
Consumables	Description
	Contains pouches with QC and calibration material, rinse solution, a gas mixture and closed containers to hold liquid and clot waste
	Holds the inlet gasket (1). This is where you put your sampling device for sample aspiration.
	Paper for the thermal printer

To see details about installed consumables

1. Tap **Menu > Analyzer status > Consumables**.
An overview is shown.
2. Choose an option and follow the steps for it.

Option	Steps
To see more data about the Solution Pack	Tap Status > Solution Pack
To see more data about the Sensor Cassette	Tap Status > Sensor Cassette

Is the analyzer ready for use?

Three important conditions

The analyzer is ready for use when three conditions are present.



1. Make sure that the analyzer is **Ready**.
2. The color of the tab of the parameters you want to get a result for is green or yellow.
3. The color of the traffic light in the **Analyzer status** button is green or yellow.

Parameter tab colors

Parameter tab color	Indication
Green	You will get a result for the parameter
Yellow with one line crossing	A QC or calibration error was found for the parameter, but you will get a result
Red with two lines crossing	No result will be reported for the parameter. The conditions that may cause a parameter tab to be red are shown below. <ul style="list-style-type: none">• An operator has locked the parameter in the Parameter setup screen• An operator has locked the analyzer (all parameter tabs will change to red)• Parameter repression was enabled for the parameter and a QC and/or calibration error is present• Ampoule-based QC measurements are pending. The analyzer was set up to lock after a Solution Pack and/or Sensor Cassette replacement until the QC measurements are completed.

To access the Analyzer status screen

1. Tap **Menu** > **Analyzer status** or, if available on the screen, just the **Analyzer status** button.

The Analyzer status screen

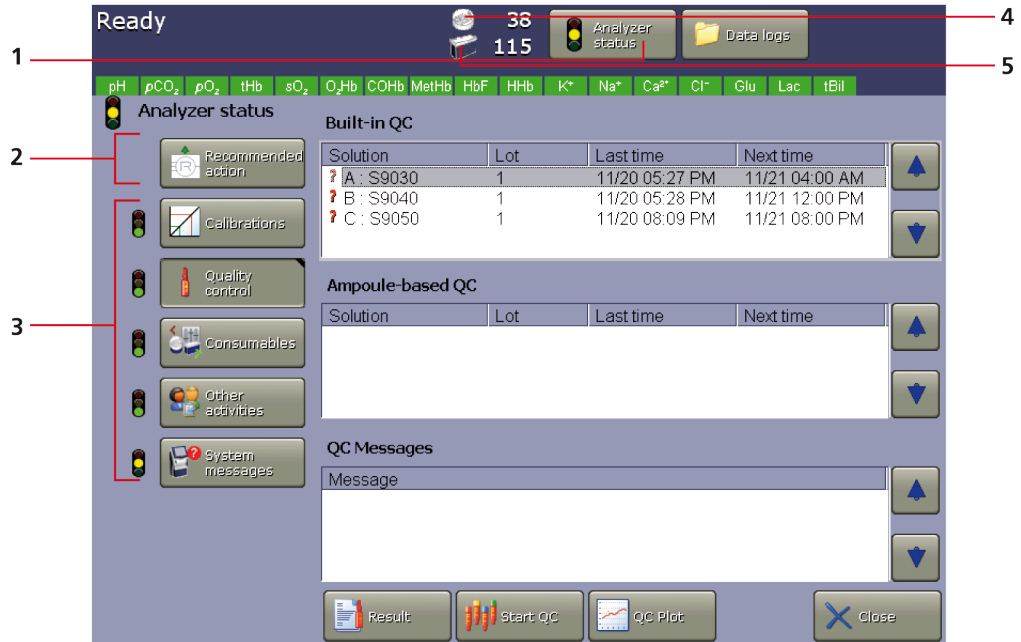

- 1 **Analyzer status** button – the color of the traffic light on the button shows the overall status of the analyzer.
- 2 **Recommended action** – if there are any recommended actions, they are shown here when the **Analyzer status** screen is opened.
- 3 Five buttons – the color of the traffic lights adjacent to each button shows the overall status of various activities within the analyzer. The buttons give access to details and activities.
- 4 **Sensor Cassette** icon – the number adjacent to the icon shows the number of tests that are left.
- 5 **Solution Pack** icon – the number adjacent to the icon shows the number of activities that are left.

Analyzer status - Traffic light colors

Traffic light color	Indication	Consequences
Green	No condition exists that requires action.	All operations are possible
Yellow	One or more messages indicate a condition that requires action, but not immediate action.	All operations are possible
Red	One or more messages indicate a condition that requires immediate action.	Only actions that are necessary to remove the reported conditions can be done.

Messages







The analyzer shows different types of message.

Message type	Where messages are shown
Status	In the Analyzer status screens
Feedback	In the space above the parameter bar. Note: Feedback messages tell operators something about an action that they have just done or about measurements and calibrations in progress. Feedback messages are shown for a short period of time.
Pop-up	In pop-up windows
Result	In result message screens
Activity	In the Activity log screen

To find and troubleshoot messages in the Analyzer status screen

Prerequisite: The traffic light in the **Analyzer status** button is yellow or red.

1. Tap **Menu > Analyzer status**.
2. Tap the button adjacent to a yellow or red traffic light.
3. Choose an option and follow the steps for it.

Option	Steps
To troubleshoot a Recommended action	Follow the instructions on the screen
To troubleshoot Quality control messages	<p>To troubleshoot errors in the Built-in QC and Ampoule-based QC fields:</p> <ol style="list-style-type: none"> a) Select the quality control measurement marked by a ,  or  symbol. b) Tap the Result button. c) Tap the Messages button. d) Select the message. e) Tap the Troubleshoot button. f) Follow the instructions on the screen. <p>To troubleshoot messages in the QC Messages field:</p> <ol style="list-style-type: none"> a) Select the message. b) Tap the Troubleshoot button. c) Follow the instructions on the screen.
To troubleshoot Calibrations messages	<p>To troubleshoot calibrations marked by a ,  or  symbol.</p> <ol style="list-style-type: none"> a) Select the marked calibration. b) Tap the Result button. c) Tap the Messages button. d) Select the message. e) Tap the Troubleshoot button. f) Follow the instructions on the screen. <p>To troubleshoot messages in the Message field:</p> <ol style="list-style-type: none"> a) Select the message. b) Tap the Troubleshoot button. c) Follow the instructions on the screen.
To troubleshoot Consumables or System messages	<ol style="list-style-type: none"> a) Select the message. b) Tap the Troubleshoot button. c) Follow the instructions on the screen.





Related information

About guided troubleshooting, page 93

Is the analyzer operating on battery power?

If a battery is installed in the analyzer, the battery indicator light will be on and a symbol in the lower right corner of the screen shows which power supply is in use.

Note: The analyzer can operate on battery power for a limited period of time. The age and charge level of the battery and the number of activities that are done limit this period.

Symbol	Battery indicator	Indication
	Yellow light that blinks slowly	Only battery power is in use
	Yellow light that blinks fast	Only battery power is in use. The analyzer must be connected to the mains power supply to prevent analyzer shutdown. Note: The color of the battery in the symbol changes to red when the level falls below 14 %. The analyzer shuts down when the level falls below 11 %.
	Green light	Only the mains power supply is in use
	Green light that blinks slowly	Only the mains power supply is in use. It supplies power to the analyzer and recharges the battery at the same time. Note: The number indicates the charge level of the battery.

Common tasks

To log on

Dependent on how your analyzer is set up, you may have to log on to the analyzer to get access to menus or buttons.

If it is necessary to log on to the analyzer, this is how to do it.

Note: It is not necessary to log on to an analyzer that is set up for anonymous use.

1. Tap **Menu > Log on**.
2. Enter or scan data into the fields.



Note: If that is not possible, tap the **Extended logon** or the **Logon BC** button and enter or scan data into the fields.

To scan a barcode

1. Hold the barcode parallel to the barcode reader and no more than 7 cm from it.



To enter text

1. Tap where you want to enter text.
2. Choose an option and follow the steps for it.

Option	Steps
To use the keyboard on the screen	a) Tap the  button. b) Enter the text. c) Tap the  button.
To use an external keyboard	a) Enter the text. b) Press the Enter key.



To select/deselect a check button

1. Choose an option and follow the steps for it.

Option	Steps
To select a check button	Tap the  check button.
To deselect a check button	Tap the  check button.

To save changes

1. Choose an option and follow the steps for it.

Option	Steps
To save changes and go to the previous screen	Tap the Back button. 
To save changes and close the screen	Tap the Close button. 

Menu

Menu structure

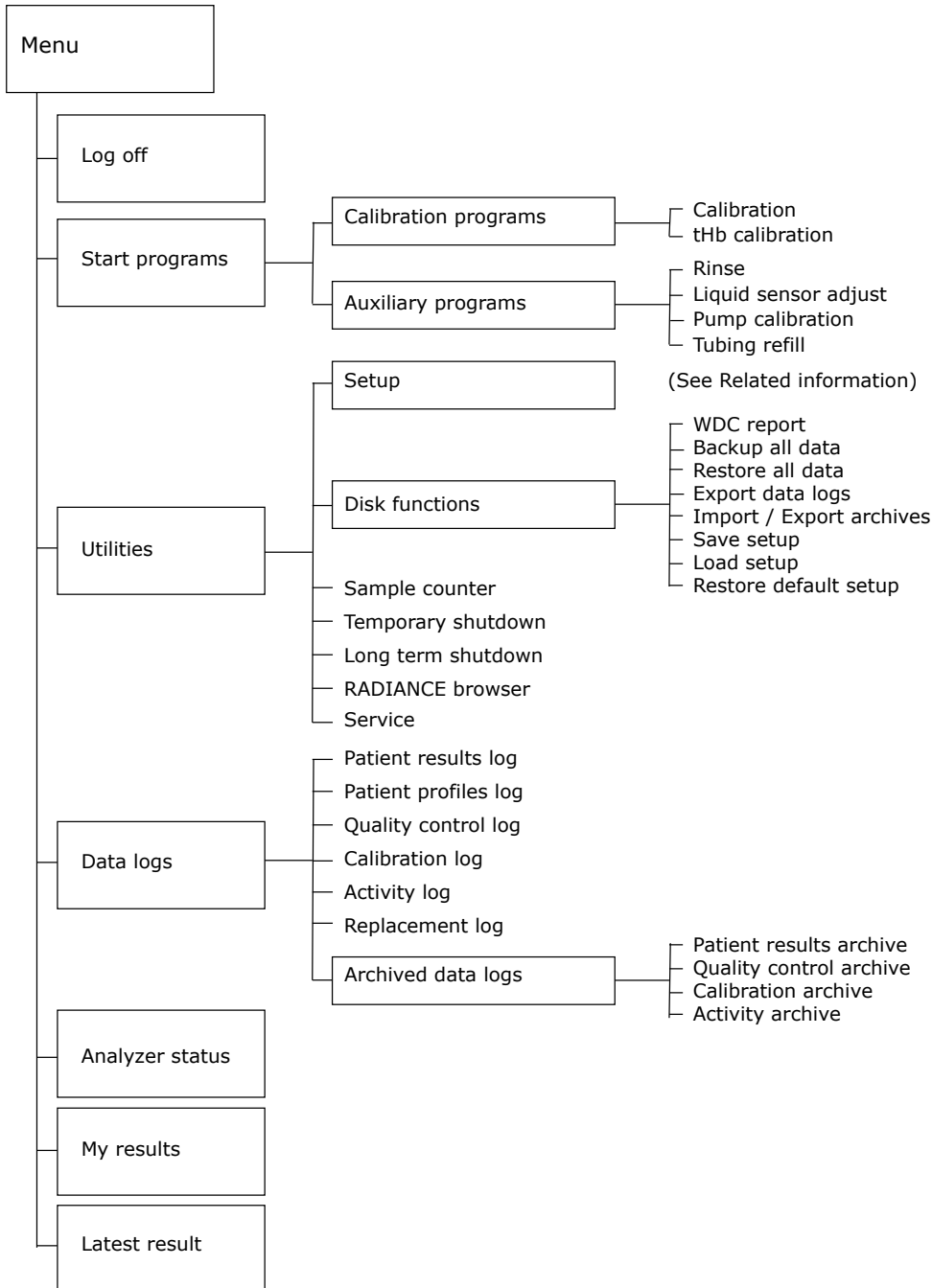

Related information
 Setup menu structure, page 143

Data logs

About data logs

Data logs are where patient data and results of measurements and activities are saved.

Overview of data logs

Data logs	Content
Patient results log	<ul style="list-style-type: none">• Results of patient sample analyses• Results of calibration verification measurements
Patient profiles log	Data that helps to identify patients whose blood has been analyzed
Calibration log	Results of calibrations
Quality control log	Results of QC measurements
Activity log	Activities done on or by the analyzer
Replacement log	Record of replacement activities
Archived data logs	The oldest results/activities from the data logs. Note: Automatic archiving must be set up.

To access data logs

1. Tap **Menu > Data logs**.
2. Tap the data log you want.

General warnings and cautions

⚠ WARNING – Risk of infection

Only let authorized personnel collect and work with blood samples. Make sure to wear gloves.

⚠ WARNING – Risk of infection

Dispose and handle all used sampling devices, quality control (QC) ampoules, Solution Packs, Sensor Cassettes, Inlet Probes, Inlet Gasket Holders, Inlet Connector Gaskets and Inlet Modules as biohazardous waste [1]. Follow your local regulations.

⚠ WARNING – Risk of infection

Make sure you do not prick or scratch yourself on the Inlet Probe.

Anticoagulants

Most Radiometer sampling devices contain dry, electrolyte-balance heparin. In general, this type of heparin gives good results, because it minimizes the bias on cNa^+ , cK^+ , cCa^{2+} results.

Different types of anticoagulant may change the concentration of some parameters and give false patient results.

Anticoagulant	Possible effect on patient results
Heparin in liquid form	Biased results on all parameters
Anticoagulants with sodium cations (Na^+)	Falsely high cNa^+ results
Anticoagulants with sodium and potassium cations (Na^+ and K^+)	False cNa^+ and cK^+ results
Anticoagulants with Lithium/Zinc heparin	False cCa^{2+} results
Anticoagulants with ammonium heparin	False cCl^- results
Disodium oxalate with sodium fluoride	Falsely high cNa^+ , falsely low cCa^{2+} and false $cGlu$ and $cLac$ results
Trisodium citrate	False cNa^+ , cK^+ , cCa^{2+} , pH , $cGlu$ and $cLac$ results
EDTA	<ul style="list-style-type: none"> False pH, pCO_2, cNa^+, cK^+ and cCa^{2+} results False cCa^{2+} results in subsequent patient samples

⚠ WARNING – Risk of incorrect results

Do not use EDTA as an anticoagulant, as it will cause incorrect pH , pCO_2 , cNa^+ , cK^+ and cCa^{2+} results and have an effect on subsequent cCa^{2+} measurements.

⚠ CAUTION – Risk of equipment damage

Do not use EDTA as anticoagulant as it will decrease the lifetime of the calcium sensor.

Good results come from good samples

What is a good sample?

Characteristics of a good sample (in sequential order)	Why are the characteristics important?
A recommended sampler is used	To prevent incorrect results
The sample is clearly and uniquely identified	To prevent a patient-sample mix-up
The sample is collected from a suitable site	To prevent incorrect results
A sufficient sample volume is collected	If there is no sufficient sample volume, the sample is lost
Air bubbles are removed immediately after collection	To prevent incorrect results
The sample is not exposed to artificial light or sunlight	To prevent incorrect ctBil results. Bilirubin can only be measured on neonatal samples. This parameter is only available in the Neonate blood analysis 65 µL mode.
The sample is gently mixed immediately after air bubbles have been removed	To prevent clots in the analyzer. If there are clots in the analyzer, the analyzer cannot analyze samples.
The sample is not shaken	To prevent hemolysis of the sample. Hemolysis can cause bias on electrolytes, especially cK ⁺ and Urea.
The sample is gently mixed again just before it is analyzed	To have a homogeneous sample for the patient sample analysis. Inhomogeneous samples may cause incorrect results.
The sample is analyzed immediately after mixing	To prevent that the sample gets too old. Note: For the best results, good samples must be analyzed immediately. When this is not possible, samples must be stored correctly, gently mixed immediately before analysis and analyzed within the time period given in the storage recommendations.

Note: The list includes most, but not all the characteristics of a good sample.

To get a good sample

Prerequisite: A recommended sampler is used.

Good results come from good samples [2,3,4]. Here are five points to remember.

1. Label the sample.
Use more than one patient identifier. For example, patient ID and sampler ID.
2. Collect the sample from a suitable site.

3. **⚠ WARNING – Risk of incorrect results**
Remove any air bubbles to prevent incorrect results.
4. **⚠ WARNING – Risk of incorrect results**
Gently mix the sample immediately after air bubbles have been removed to prevent clots.
To mix the sample, follow your local standard operating procedure and the instructions for use for the sampling device.
5. Analyze the sample immediately after mixing.
Note: When this is not possible, store the sample correctly, gently mix it just before analysis and analyze it within the time period given in the storage recommendations.

To mix a sample on the analyzer

Pre-requisite: A *safe*PICO syringe with a *safe*TIPCAP

Note: If the sample is in a *safe*PICO syringe with a *safe*TIPCAP cap, do not remove the *safe*TIPCAP cap.

1. Put the syringe in the sample mixer.
2. Wait until the light starts blinking.
3. Remove the syringe.

Storage recommendations

These types of blood samples must be analyzed immediately after they are collected [5,6]:

- Samples with increased leukocyte or platelet counts
- Samples with an atypical metabolism
- Fetal scalp samples
- Fast-clotting samples
- Samples with high pO_2 values should be analyzed within 5 minutes after they are collected [7].

⚠ WARNING – Risk of biased results especially pO2 results

Interpret with caution the results for samples in capillary tubes as the aerobic sampling technique may cause bias.

Samples that cannot be analyzed immediately after they are collected must be handled and stored correctly before they are analyzed [3,8]. The table provides an overview.

Sampling device	Type	Handling and storage temperatures	Analyze within this time period
Syringe	Plastic	Keep at room temperature [2,9,10,11,12,13]	<30 minutes
Syringe	Glass	Keep at room temperature [2,3]	<30 minutes
		Keep in water at 0-4 °C. Note: Do not keep the sample on ice as it can cause hemolysis** [7,11,12,13].	<60 minutes
Capillary tube	Plastic*	Keep at room temperature	<10 minutes
Capillary tube	Glass	Keep at room temperature	<10 minutes

Sampling device	Type	Handling and storage temperatures	Analyze within this time period
Capillary tube	Glass	Keep the sample horizontal at 0-4 °C. Note: Do not keep the sample on ice as it can cause hemolysis** [7,11,12,13].	<30 minutes

* Samples in *safeCLINITUBES* capillary tubes deteriorates with increased storage time (greater variability of gasses and of tHb measurements).

** Hemolysis can cause bias on electrolytes, especially cK⁺.

Pre-registration of samples

About sample pre-registration

Sample pre-registration lets operators make sure that the patient data shown on the screen belongs to the patient whose sample is to be analyzed. This reduces the risk of patient/sample mix-up.

Note: The analyzer must be set up for sample pre-registration.

Related information

To set up sample pre-registration, page 162

To pre-register a sample

Prerequisites:

- The analyzer is set up for sample pre-registration
- A barcode that identifies the patient and/or the blood sample

1. Scan the barcode.
2. Make sure the data that is shown on the screen belongs to the patient whose sample you want to analyze.

Option	Steps
If the data is correct	a) Analyze the sample.
If the data is not correct	a) Tap the Cancel button.

Related information

To analyze a sample from a syringe, page 21

To analyze a sample from a capillary tube, page 22

To analyze a sample from a test tube, page 24

Analyzing patient samples

General information for obtaining successful patient sample analyses

The analyzer will guide you through the different steps of the patient sample analysis process. Depending on the setup, the process will vary. Always look at the screen and follow the instructions on the screen.

Depending on the setup:

- You may be able to select measurement mode during sample analysis. If so, you must select a measurement mode, or the analyzer will automatically select the measurement mode set up as default in the setup.
- In the **Patient identification** screen, it is mandatory to enter data in fields with this icon: 

The sample will be analyzed, but the results will not be available until data is entered.

- In the **Patient identification** screen, it is possible to change the report layout during sample analysis.

During patient sample analysis, make sure that the Inlet Probe does not touch the plunger of or the fiber disk in the syringe as this may cause the sample to be aspirated incorrectly.

If there is <1.1 mL in a PICO50 sampler or <0.7 mL in a PICO70/*safe*PICO70 sampler, you must be careful with this.

In order not to bend the Inlet Probe, hold the sampling device still during sample analysis. If the Inlet Probe is bent, do not use the analyzer for sample analysis.

To analyze a sample from a syringe

Prerequisites:

- A good sample (no air bubbles, no exposure to air, and no clots)
- Make sure that the analyzer is **Ready**
- An Inlet Clip is installed if a non-Radiometer syringe is used. Contact your Radiometer representative for more information.

Note: If the sample is in a *safe*PICO syringe with a *safe*TIPCAP cap, do not remove the *safe*TIPCAP cap during sample analysis.

Note: Once the inlet is opened, you only have a short time to complete the actions necessary.

1.  **WARNING – Risk of incorrect results**
Gently mix the sample to make sure that it is homogeneous.
2. Hold the syringe by its barrel.
3. Lift the inlet handle to the syringe position.

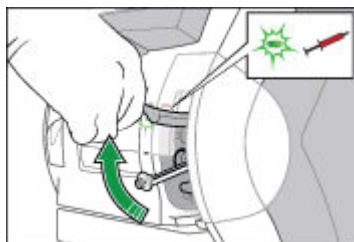

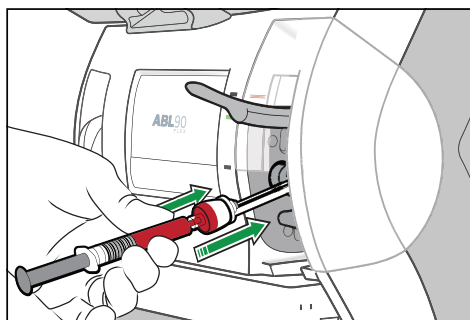

4. If measurement mode can be selected, select measurement mode.
 **WARNING – Risk of missing results**
Make sure that you select the Neonate blood analysis mode to get neonatal ctBil results on neonatal samples*
Note: If you selected the wrong mode, tap the **Reselect** button and select the correct mode.
Note: If the **Other modes** button is available, tap it to get access to more modes.
5. Follow the instructions on the screen.

6. Place and hold the tip of the syringe in the center of the Inlet Gasket.
7. **⚠ WARNING – Risk of incorrect tHb results**
Push the syringe into the analyzer as far as it will go and hold it there.

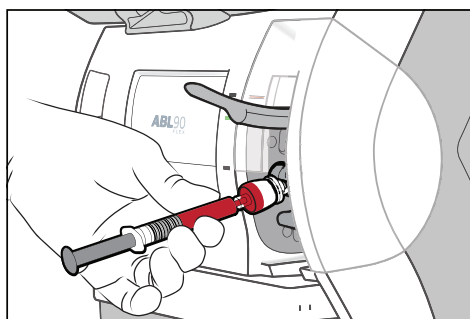

8. Hold the syringe in the pushed-in position until the analyzer tells you to remove it.



9. When the analyzer tells you to, remove the syringe.
10. Close the inlet.
11. If necessary, select a different report layout as follows:
 - a) Tap the current **Report layout** shown on the screen.
 - b) Select a new layout from the list.
 - c) Tap the **Select** button.
12. Enter the necessary data in the **Patient identification** screen.
Note: It is mandatory to enter data in fields with this icon: 
13. If the **Patient result** screen opens before you have entered the necessary data, tap the **ID** button.

*Bilirubin can only be measured on neonatal samples. This parameter is only available in the Neonate blood analysis 65 µL mode.

Related information

To pre-register a sample, page 20

To get a good sample, page 18

To analyze a sample from a capillary tube

Prerequisites:

- A good sample (no air bubbles, no exposure to air, and no clots)
- Make sure that the analyzer is **Ready**

To prevent clots, it is recommended that you use an ABL90 FLEX Clot Catcher.



Note: Once the inlet is opened, you only have a short time to complete the actions necessary.

1. **⚠ WARNING – Risk of incorrect results**
Gently mix the sample to make sure that it is homogeneous.
2. Move the mixing wire to the end opposite to that from which the sample is to be aspirated.

Note: If petroleum jelly, such as Vaseline, is used at the puncture area, introduce the capillary sample into the analyzer from the end without petroleum jelly.

3. Remove the end caps of the capillary tube.
4. Put the Clot Catcher on the end opposite to that with the mixing wire.
5. Hold the capillary tube and lift the inlet handle to the capillary tube position.

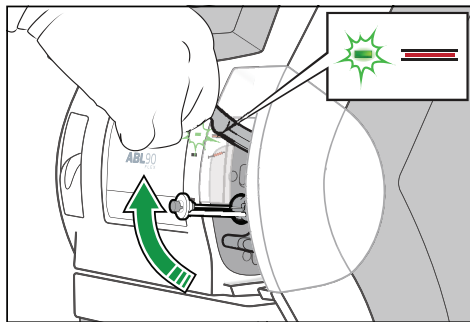

6. If measurement mode can be selected, select measurement mode.

⚠ WARNING – Risk of missing results

Make sure that you select the Neonate blood analysis mode to get neonatal ctBil results on neonatal samples*

Note: If you selected the wrong mode, tap the **Reselect** button and select the correct mode.

Note: If the **Other modes** button is available, tap it to get access to more modes.

7. Follow the instructions on the screen.
8. Place and hold the end with the Clot Catcher in the center of the Inlet Gasket.

Note: If you turn the capillary tube slightly when you place it in the center, it may be easier to put it in the right place.

9. Carefully push the capillary tube into the analyzer as far as it will go and hold it there.

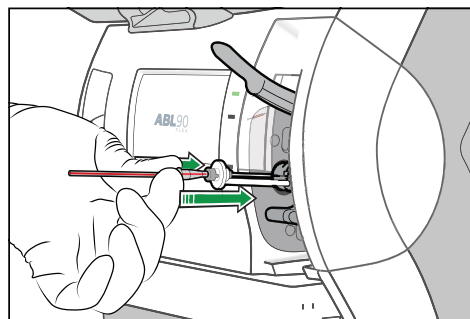

10. Hold the capillary tube in the pushed-in position until the analyzer tells you to remove it.

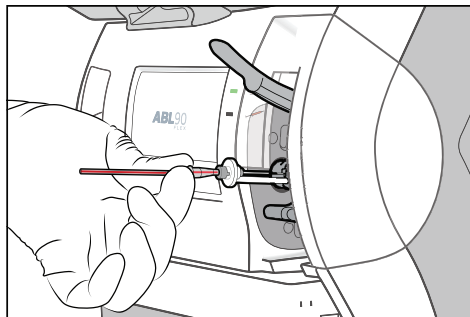

11. When the analyzer tells you to, remove the capillary tube.
 12. Close the inlet.
 13. If necessary, select a different report layout as follows:
 a) Tap the current **Report layout** shown on the screen.
 b) Select a new layout from the list.
 c) Tap the **Select** button.
 14. Enter the necessary data in the **Patient identification** screen.
Note: It is mandatory to enter data in fields with this icon: 
 15. If the **Patient result** screen opens before you have entered the necessary data, tap the **ID** button.

*Bilirubin can only be measured on neonatal samples. This parameter is only available in the Neonate blood analysis 65 µL mode.

Related information

To pre-register a sample, page 20

To get a good sample, page 18

To analyze a sample from a test tube

Prerequisites:

- A good sample (no air bubbles, no exposure to air, and no clots)
- Make sure that the analyzer is **Ready**
- No Inlet Clip is installed on the Inlet Gasket Holder

Note: Once the inlet is opened, you only have a short time to complete the actions necessary.

1.  **WARNING – Risk of incorrect results**
Gently mix the sample to make sure that it is homogeneous.
2. Uncap the test tube.
3. Hold the test tube and lift the inlet handle to the syringe position.

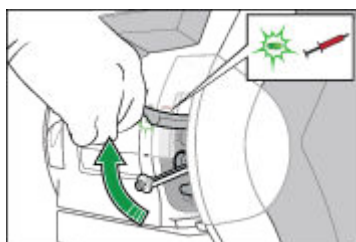

4. If measurement mode can be selected, select measurement mode.

⚠ WARNING – Risk of missing results

Make sure that you select the Neonate blood analysis mode to get neonatal ctBil results on neonatal samples*

Note: If you selected the wrong mode, tap the **Reselect** button and select the correct mode.

Note: If the **Other modes** button is available, tap it to get access to more modes.

5. Follow the instructions on the screen.
6. Place and hold the lip of the test tube against the collar of the Inlet Gasket.
7. Push the test tube into the analyzer as far as it will go and hold it there.

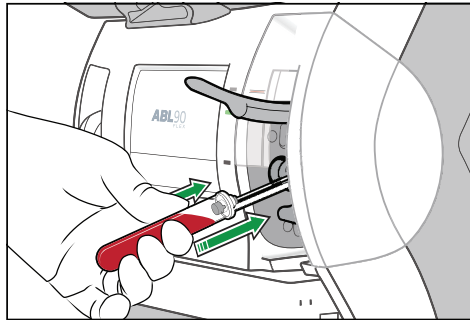

Note: Make sure that the probe extends into the sample and stays there during sample aspiration.

8. Hold the test tube in the pushed-in position until the analyzer tells you to remove it.

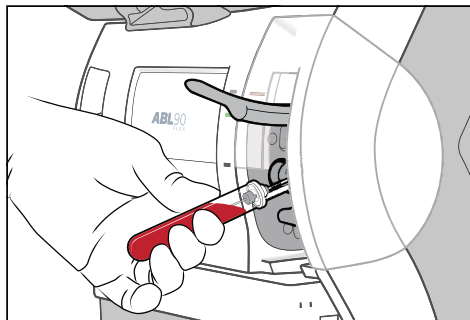

9. When the analyzer tells you to, remove the test tube.
10. Close the inlet.
11. If necessary, select a different report layout as follows:
 - a) Tap the current **Report layout** shown on the screen.
 - b) Select a new layout from the list.
 - c) Tap the **Select** button.
12. Enter the necessary data in the **Patient identification** screen.

Note: It is mandatory to enter data in fields with this icon: 

13. If the **Patient result** screen opens before you have entered the necessary data, tap the **ID** button.

*Bilirubin can only be measured on neonatal samples. This parameter is only available in the Neonate blood analysis 65 µL mode.

Related information

To pre-register a sample, page 20

To get a good sample, page 18

To get calculated values for $FShunt$ and $ctO_2(a-\bar{v})$

Prerequisites:

- A patient report layout for $FShunt$ and $ctO_2(a-\bar{v})$ has been created
- A mixed-venous blood sample and an arterial blood sample, collected directly after each other from the patient

1. Analyze the mixed-venous blood sample. Use the report layout created for $FShunt$ and $ctO_2(a-\bar{v})$.
2. Enter data in the **Patient identification** screen.
Note: If the **Patient identification** screen closes before you have entered the necessary data, tap the **ID** button to get back to the **Patient identification** screen.
3. Note the values for these parameters. You need them for steps 6 to 9 inclusive:
 - $pO_2(\bar{v})$
 - $sO_2(\bar{v})$
 - $FO_2(I)$
 - RQ
 - T
4. Analyze the arterial sample. Use the report layout created for $FShunt$ and $ctO_2(a-\bar{v})$.
5. Select "Arterial" for **Sample type**.
6. Enter the values for $pO_2(\bar{v})$ and $sO_2(\bar{v})$ that were noted in step 3.
7. If the $FO_2(I)$ value is not equal to the default value of 0.21, enter the value you noted in step 3.
8. If the RQ value is not equal to the default value of 0.86, enter the value you noted in step 3.
9. If the T value is not equal to the default value of 37 °C, enter the value you noted in step 3.
10. Enter other data in the **Patient identification** screen.
Note: If the **Patient identification** screen closes before you have entered the necessary data, tap the **ID** button to get back to the **Patient identification** screen.

Note: If no value is entered for $pO_2(\bar{v})$, $sO_2(\bar{v})$, $FO_2(I)$, RQ or T , the $FShunt$ value will be estimated.

Note: If no value is entered for $pO_2(\bar{v})$ and $sO_2(\bar{v})$, a default value will be used for $ctO_2(a-\bar{v})$.

Related information

To create a patient report layout, page 163

Entering and editing data in the Patient identification screen

The Patient identification screen

The content of the **Patient identification** screen shown below shows the items included in the **-R- Default** report layout. Other layouts can be created.

The screenshot shows the 'Patient identification' screen with the following fields and options:

- Patient ID: 123
- Patient last name: aaa
- Patient first name: bbb
- Sample type: Not specified
- T: 37.0 °C
- Report layout: -R- Default
- Sample type options: Not specified, Arterial, Venous, Capillary, Mixed venous, Prof. Test, Cord Blood, Fetal Scalp
- Buttons: Result, Parameters, Back, and a Select button.

To change the report layout in the Patient identification screen

When you change the report layout, data fields in the **Patient identification** screen can change.

1. Tap the current **Report layout**.
2. Select a new layout.
3. Tap the **Select** button.

To request patient data automatically when connected to a LIS/HIS system

Prerequisites:

- The analyzer is connected to a LIS/HIS/data management system
- The analyzer is set up to enable automatic requests for patient data

1. In the **Patient identification** screen, enter data in the field that was set up to enable data to be requested automatically.

Note: It will be one of these fields: **Accession number** or **Patient ID** or **Sampler ID**.

Note: If no data is transmitted, tap the **Request** button.

To request patient data using Patient lookup

Prerequisites:

- The Patient report includes the **Department (Pat.)** field
- The analyzer is set up to enable patient lookup

1. In the **Patient identification** screen, enter data in the **Department (Pat.)** field.
2. Tap the **Patient lookup** button.
3. Select the patient from the list.
4. Tap the **Select** button.

Based on the Patient ID of the patient you selected, data is requested and downloaded to the **Patient identification** screen.

To edit data in the Patient identification screen

1. Find the patient result.
2. Tap the **ID** button.
3. Edit the necessary data.

Patient results







To find a patient result

1. Choose an option and follow the steps for it.

Option	Steps
To find a result in the data log	<ol style="list-style-type: none"> a) Tap Menu > Data logs > Patient results log. b) Select the measurement. c) Tap the Result button.
To find a number of results in the data log	<ol style="list-style-type: none"> a) Filter the data from the Patient results log
To find the latest result	<ol style="list-style-type: none"> a) Tap Menu > Latest result.
To find a result under My results	<ol style="list-style-type: none"> a) Tap Menu > My results. b) Select the measurement. c) Tap the Result button.

Symbols on patient results

Problems on patient results are marked with one or more of the symbols shown in the table.

Symbol	Description
	An error occurred. A message attached to the result describes the error.
	Result is above the reference range but below the upper critical limit
	Result is below the reference range but above the lower critical limit
	Result is above the upper critical limit but below the upper limit of the reportable range
	Result is below the lower critical limit but above the lower limit of the reportable range
	No result is shown because it is above the upper limit of the reportable range. Note: The analyzer can be set up to show the result as greater than the value of the upper limit of the reportable range. For example: All pH results above 7.850 (the upper limit of a pH reportable range) will be shown as >7.850.

Symbol	Description
⚡	No result is shown because it is below the lower limit of the reportable range. Note: The analyzer can be set up to show the result as less than the value of the lower limit of the reportable range. For example, all pH results below 6.750 (the lower limit of the pH reportable range) will be shown as <6.750.
.....	No result could be calculated
(blank)	No result is shown because it is outside the range of indication* of the analyzer.
*	User-defined correction factors were used to calculate the result
c	A subscript of the letter c shows that the value was calculated from measured and/or keyed-in (input) values. Only shown on derived parameters.
e	A subscript of the letter e shows that the value was estimated. Default values were used to replace measured and/or keyed-in (input) values that were not available. Only shown on derived parameters.

* The Range of indication is the range the analyzer is capable of measuring and includes values outside the Reportable range. The performance of the analyzer outside the Reportable range specified in the *Specifications* chapter has not been validated. Only results within the Reportable range should be reported.

About ranges and critical limits

Measurement results are marked by symbols to show where they fall in relation to reference ranges, critical limits and reportable ranges. The diagram illustrates these relationships.

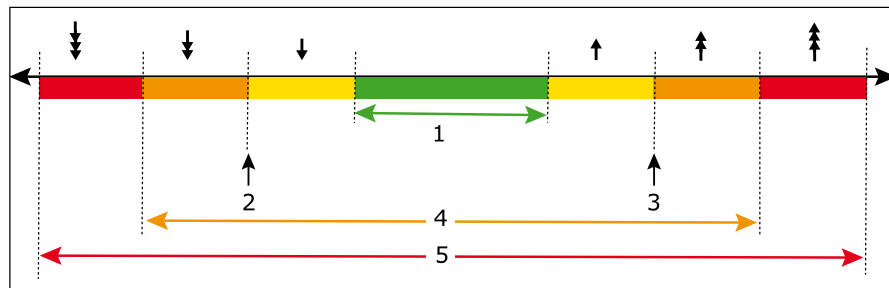

- 1 Reference range
- 2 Lower critical limit
- 3 Upper critical limit
- 4 Reportable range
- 5 Range of indication

The Range of indication is the range the analyzer is capable of measuring and includes values outside the Reportable range. The performance of the analyzer outside the Reportable range specified in the *Specifications* chapter has not been validated.

Only results within the Reportable range should be reported.

Status in the Patient results log

The **Status** column in the **Patient results log** screen shows the overall status of each patient sample analysis.

Symbol	Description
OK	The sample analysis was successful
?	An error was found on one or more parameter result.
Aborted	The sample analysis was stopped by the analyzer because it found an error

To see messages on patient results

Prerequisite: There are messages on the patient result.

1. Tap **Menu** > **Data logs** > **Patient results log**.
2. Select the measurement.
3. Tap the **Result** button.
4. Tap the **Messages** button or tap the **Log** > **Messages** buttons.

To troubleshoot messages on results

Prerequisite: You can see the message you want to troubleshoot.

1. Select the message.
2. Tap the **Troubleshoot** button.
3. Follow the instructions on the screen.

To see the acid-base chart for a result

Prerequisite: The sample type must be specified as "Arterial" and the results must include pH and $p\text{CO}_2$ values.

1. Tap **Menu** > **Data logs** > **Patient results log**.
2. Select the measurement.
3. Tap the **Result** button.
4. Tap the acid-base chart button.



Note: The chart must only be used as a guideline.

Reviewing and editing patient results

To filter data from the Patient results log

1. Tap **Menu** > **Data logs** > **Patient results log**.
2. Tap the **Filter** button.
3. In the **Criteria** frame, choose an option and follow the steps for it.

Option	Steps
To select a time period prior to today's date	Tap the number button for the number of days you want
To select a start and end date	Enter data in the Start date: and End date: fields

4. Select the next criterion. If necessary, enter or select a value for it.

5. If more criteria are necessary, tap the **More** button.
6. If necessary, do step 4 again.
7. Tap the **Apply** button.

To see trends in a patient's results

Prerequisite: You have filtered the patient's results from the **Patient results log**.

1. Tap the **Trend** button.
2. Select the parameters.
3. Tap the **View trend** button.

To see the audit trail on a patient result

Prerequisite: Changes were made to the patient result.

An audit trail shows the changes made to a patient result.

1. Tap **Menu > Data logs > Patient results log**.
2. Select the measurement.
3. Tap the **Result** button.
4. Tap the **Log > Audit trail** buttons.

Note: The **Log** button will only be available if changes were made to the patient result.

To add a note to a patient result

1. Tap **Menu > Data logs > Patient results log**.
2. Select the measurement.
3. Tap the **Result** button.
4. Tap the **Messages** button.
5. Tap the **Note** button.
6. Choose an option and follow the steps for it.

Option	Steps
If a pop-up window is shown	To use one of the listed notes: <ul style="list-style-type: none"> • Select the note • Tap the Enter button To enter a new note: <ul style="list-style-type: none"> • Tap the Edit Note button. • Enter the note.
If no pop-up window is shown	Enter a note.

7. Tap the **Back > Close** buttons.

To remove a parameter from a patient result

Prerequisite: The result is not approved or rejected.

1. Tap **Menu > Data logs > Patient results log**.
2. Select the measurement.
3. Tap the **Result > ID > Parameters** buttons.

4. Deselect the check buttons for the parameter you want to remove.
5. Tap the **Back** > **Back** > **Close** buttons.

Note: The result of the parameter is removed from the **Patient results** screen and from printed results.

To show a parameter in a patient result

Prerequisites:

- The parameter was removed from the patient result
- The patient result is not approved or rejected

This procedure allows you to see the parameter on the screen and in printed results.

1. Tap **Menu** > **Data logs** > **Patient results log**.
2. Select the measurement.
3. Tap the **Result** > **ID** > **Parameters** buttons.
4. Select the check button for the parameter you want to see.
5. Tap the **Back** > **Back** > **Close** buttons.

Approval and rejection of patient results

Approval/rejection of patient results is not set up by default. If it is set up, it can be used to filter patient results that are transmitted to a LIS/HIS system. Approved results are transmitted, rejected results are not.

Note: An approved patient result does not indicate that the result can be used in a clinical evaluation of the patient.

Approval can for example be used to make sure that necessary data was correctly entered, for example, that the **Sample type** was "Venous", not "Arterial" and the patient temperature was 42 °C, not 38 °C.

Note: Approved/rejected results cannot be edited.

To approve a patient result

1. Tap **Menu** > **Data logs** > **Patient results log**.
2. Select the measurement.
3. Tap the **Result** button.
4. Tap the **Approval** > **Approve** buttons.
5. Tap the **Accept** button.
6. Tap the **Back** > **Close** buttons.

To reject a patient result

1. Tap **Menu** > **Data logs** > **Patient results log**.
2. Select the measurement.
3. Tap the **Result** button.
4. Tap the **Approval** > **Reject** buttons.
5. Tap the **Accept** button.
6. Tap the **Back** > **Close** buttons.

Critical limit notification

About Critical limit notification

In some countries physicians must be notified when a patient result lies outside the critical limit.

When **Critical limit notification** is enabled, a notification procedure is necessary before results with values outside the critical limit can be transmitted to external systems and printed automatically. The results are pending until a notification procedure is done. The results can be seen in **Pending results log**.

To enable Critical limit notification

1. Tap **Menu > Utilities > Setup > General setup > Miscellaneous setup**.
2. Tap **Enable critical limit notification**.
3. Tap the check button.
4. Tap the **Close** button.

Note: If a print of the result is needed, you can make a print from the **Notification** screen. The printout will tell you that the notification is pending.

To use Critical limit notification

1. Choose an option and follow the steps.

Option	Steps
If a pop-up window notifies you that the result has values that lie outside critical limits.	a) Go to step 2.
If an exclamation mark is shown on the Data logs button.	a) Tap Data logs > Pending results log . b) Highlight a result. c) Tap the Result button. Note: A pop-up window notifies you that the result has values that lie outside critical limits.

2. Tap inside the message to close the pop-up window.
3. Tap **Notification**.
4. See the values that are outside critical limits.
Note: If it is not necessary to notify about the values, tap **Not needed** and go to step 6.
5. Call the physician or person responsible for the treatment and notify them about the values.
6. Fill in the data fields on the screen.
7. Tap the **Accept** button.

Pending results log

The **Pending results log** contains the following results:

- Results that someone needs to be notified about
- Results that need to be approved
- Results that need mandatory input

Results in the **Pending results log** are filtered from the **Patient results log** and remain pending until they have been dealt with. If results are pending, an exclamation mark is shown on the **Data logs** button.

To access the Pending results log

1. Tap **Data logs** > **Pending results log**.

Input fields for the Patient report layout

The following notification-related input fields can be added to the patient report layout:

- Notified whom
- Notified time
- Notified by
- Notification status
- Notification

Note: To include these items in a patient report layout, see *Reviewing and editing patient results*.

References

1. Clinical laboratory waste management. CLSI/NCCLS document GP5-A2, Clinical Laboratory Standards Institute, 940 West Valley Road, Suite 1400, Wayne, Pennsylvania 19087-1898 USA.
2. CLSI. Procedures for the collection of arterial blood specimens; approved standard - Fourth Edition. CLSI/NCCLS document H11-A4, Clinical Laboratory Standards Institute, 940 West Valley Road, Suite 1400, Wayne, Pennsylvania 19087-1898 USA, 2004.
3. CLSI. Blood gas preanalytical considerations: specimen collection, calibration and controls; Approved guideline. CLSI/NCCLS document C27-A, Clinical Laboratory Standards Institute, 940 West Valley Road, Suite 1400, Wayne, Pennsylvania 19087- 1898 USA, 1993.
4. CLSI. Procedures and devices for the collection of diagnostic capillary blood specimens; approved standard - Fifth Edition. CLSI/NCCLS document H4-A5, Clinical Laboratory Standards Institute, 940 West Valley Road, Suite 1400, Wayne, Pennsylvania 19087-1898 USA, 2004.
5. Woolley A, Hickling K. Errors in measuring blood gases in the intensive care unit: Effect of delay in estimation. *J Crit Care* 2003; 18: 31-37. 12. Blonshine S. To ice or not to ice. *AARC Times* 2000: 37-39.
6. Nickelsen CN. Fetal capillary blood pH. www.bloodgas.org, 2002.
7. Burnett RW, Covington AK, Fogh-Andersen N et al. Approved IFCC recommendations on whole blood sampling, transport and storage for simultaneous determination of pH, blood gases and electrolytes. *Eur J Clin Chem Clin Biochem* 1995; 33: 247-53.
8. Skurup A. Storage recommendations for blood gas samples. Radiometer Publication bulletin no. 31-2006. Copenhagen: Radiometer Medical A/S. Code no. 918-686.
9. Mahoney JJ, Van Kessel A. Arterial blood gas analysis. *Respir Care* 1997: 249-79.
10. Smeenk F, Janssen J, Arends B, Harff G, Bosch J, Schönberger J, Postmus P. Effects of four different methods of sampling arterial blood and storage time on gas tensions and shunt calculation in the 100% oxygen test. *Eur Respir J* 1996; 10: 910-13.
11. Mahoney JJ, Harvey JA, Wong RJ, Kessel VLA. Changes in oxygen measurements when whole blood is stored in iced plastic or glass syringes. *Clin Chem* 1991; 37: 1244-48.
12. Blonshine S. To ice or not to ice. *AARC Times* 2000: 37-39.
13. Liss P, Payne P. Stability of blood gases in ice and at room temperature. *Chest* 1993; 103: 1120-21.

Replacements and maintenance 4

General warnings and cautions

⚠ WARNING – Risk of infection

Only let authorized personnel collect and work with blood samples. Make sure to wear gloves.

⚠ WARNING – Risk of infection

Dispose and handle all used sampling devices, quality control (QC) ampoules, Solution Packs, Sensor Cassettes, Inlet Probes, Inlet Gasket Holders, Inlet Connector Gaskets and Inlet Modules as biohazardous waste [1]. Follow your local regulations.

⚠ WARNING – Risk of infection

Make sure you do not prick or scratch yourself on the Inlet Probe.

⚠ WARNING – Risk of infection

Make sure that you wear gloves during replacement and maintenance procedures.

To order products for use with your analyzer

1. Find the code number for the product.
2. Contact your local Radiometer representative.

Related information

Solution Packs - code numbers, page 385

Sensor Cassettes - code numbers, page 385

Spare parts and accessories - code numbers, page 385

Quality control products - code numbers, page 386

Replacement intervals for consumables and Inlet Connector Gasket

The recommended replacement intervals shown in the table are only a guideline. They are based on a default of 10 sample analyses per day. For analyzers with a higher sample throughput, the number of **Expected measurements per day** can be changed in the setup, so the analyzer can calculate the most probable replacement date and send a message about it.

Consumables	Default tests or activities per day	Recommended replacement interval after installation
Solution Pack	10	Maximum 30 days or when the number of activities is zero
Sensor Cassette	10	Maximum 30 days or when the number of tests is zero
Inlet Gasket Holder	10	12 months
Inlet Connector Gasket	10	12 months

Related information

To set up replacement warnings, page 197

Replacements

Solution Pack

To see the Solution Pack status

1. Tap **Menu** > **Analyzer status** > **Consumables**.
2. For more information, tap the **Status** > **Solution Pack** buttons.

To replace the Solution Pack

Prerequisite:

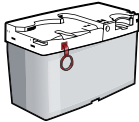

A new Solution Pack

1. Tap **Menu** > **Analyzer status**.
2. Tap the **Consumables** > **Replace** > **Solution Pack** buttons.
3. Tap the **Press to start video guidance** button.
4. Lift the inlet handle to the capillary position.

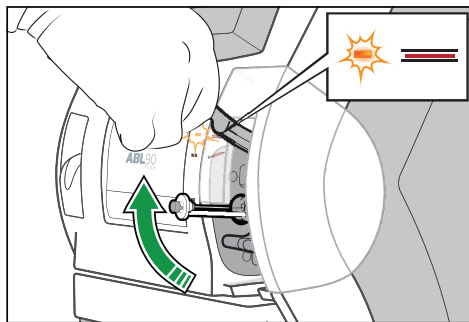

5. Wait until the Solution Pack is released.
Note: If the Solution Pack is not released, you can release it manually.
6. Remove the Solution Pack and dispose of it as biohazardous waste.

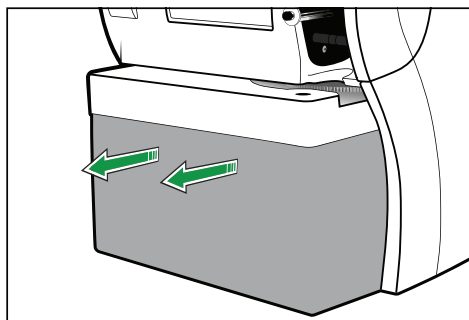

7. Lift the new Solution Pack out of its box as shown.

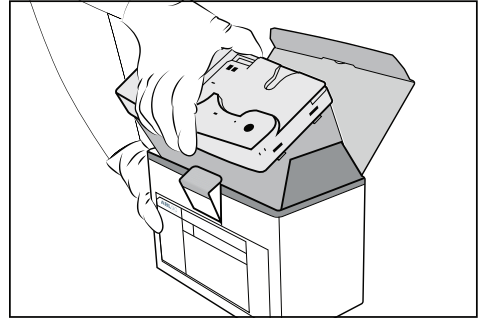
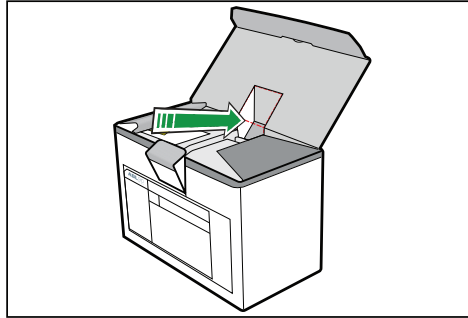

8. Pull the red pin out of the new Solution Pack.

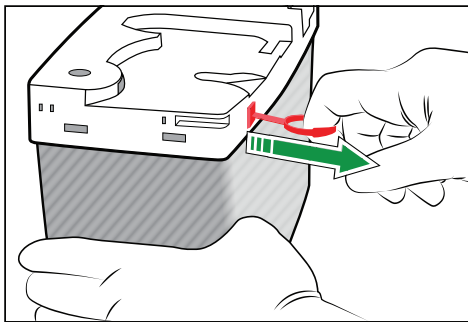

9. Put the palms of your hands over the edges of the lid as shown.

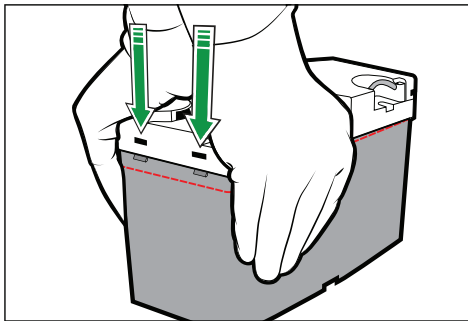

10. Press down firmly and evenly with both hands until the tabs click into the 2 holes.
Note: For the Solution Pack to be activated correctly, both tabs must click in place.



11. Tap the **Action Completed** button.

12. Put your thumbs on the white part of the Solution Pack and push the Solution Pack into its compartment until it clicks in place.

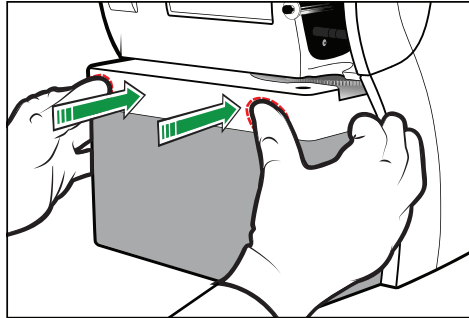

13. When the analyzer tells you to, close the inlet.
14. Enter necessary data.
15. Tap the **OK** button.

To release the Solution Pack manually

Note: Use this procedure to release the Solution Pack from its compartment if it is not automatically released during a replacement or maintenance procedure.

1. Press the Solution Pack into the analyzer while you press down the latch on the back of the analyzer.

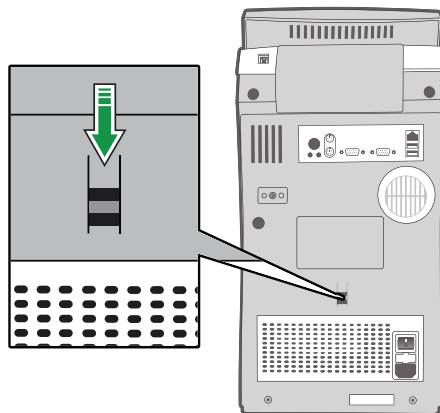

2. Remove the Solution Pack.

Can a Solution Pack be used again?

A Solution Pack removed from one analyzer can be used on another if these 3 conditions are met:

- the Solution Pack is installed before its **Scheduled to replace:** date
- the Solution Pack is installed before its **Expiration date:**
- the Solution Pack has some remaining activities

This data can be seen in the **Solution Pack Status** screen.

Related information

To see the Solution Pack status, page 36

Status logs

Status logs include all the data that tells something about the performance of a consumable that has been removed from the analyzer. The data can be printed or exported to a USB flash drive.

To print Solution Pack status logs

1. Tap **Menu > Data logs > Replacement log**.
2. Select the "Solution pack removed" activity.
3. Tap the **Send status to printer** button.

To export Solution Pack status logs

Prerequisites:

- A USB flash drive

1. Plug in the USB flash drive.
2. Tap **Menu > Data logs > Replacement log**.
3. Select the "Solution pack removed" activity.
4. Tap the **Export status logs** button.

Sensor Cassette

To see the Sensor Cassette status

1. Tap **Menu > Analyzer status > Consumables**.
2. For more information, tap the **Status > Sensor Cassette** buttons.

To replace the Sensor Cassette

Prerequisite:

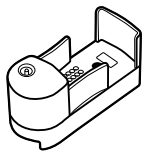

A new Sensor Cassette

Note: The analyzer has to condition a new Sensor Cassette after it is installed. This process can take up to 4 hours.

1. Tap **Menu > Analyzer status**.
2. Tap the **Consumables > Replace > Sensor Cassette** buttons.
3. Tap the **Press to start video guidance** button
4. Wait until the Sensor Cassette compartment opens.

5. Remove the Sensor Cassette and dispose of it as biohazardous waste.



6. Tap the **Action Completed** button.
7. Pull the foil off the new Sensor Cassette Pack, unscrew the lid and lift out the Sensor Cassette.
8. Tap the **Action Completed** button.
9. Press the new Sensor Cassette in place.



10. Tap the **Action Completed** button.
11. Enter necessary data.
12. Tap the **OK** button.

Note: If you tap the **Exit conditioning** button, the more frequent calibrations that normally follow in the 24 hours after a Sensor Cassette replacement will not be done. This may have an effect on the accuracy and precision of patient results in this period of time.

Related information

Can a Sensor Cassette be used again?, page 41

Calibration frequency after a Sensor Cassette replacement

Calibrations are done more frequently in the 24-hour period that follows a Sensor Cassette replacement. This has an effect on the number of analyses that can be done per hour during this time period.

Note: A calibration takes up to 2½ minutes.

Time period after a replacement	Calibration frequency
0-4 hours	In connection with every measurement
4-6 hours	Every 15 minutes
6-8 hours	Every 30 minutes
8-12 hours	Every hour

Time period after a replacement	Calibration frequency
12-24 hours	Every 2 hours

Related information

Frequency of automatic calibrations, page 85

Can a Sensor Cassette be used again?

A Sensor Cassette removed from one analyzer can be used on the same or on another ABL90 FLEX analyzer if these 6 conditions are met.

- The Sensor Cassette is kept right side up after its removal. This prevents damage to the sensors.
- The Sensor Cassette is installed within 2 hours of its removal
- The Sensor Cassette is installed before its **Scheduled to replace** date
- The Sensor Cassette is installed before its **Expiration date**
- The Sensor Cassette has some remaining activities
- The Sensor Cassette was not removed from an analyzer during a long-term shut-down procedure

This data can be seen in the **Sensor Cassette Status** screen.

Related information

To see the Sensor Cassette status, page 39

Status logs

Status logs include all the data that tells something about the performance of a consumable that has been removed from the analyzer. The data can be printed or exported to a USB flash drive.

To print Sensor Cassette status logs

1. Tap **Menu > Data logs > Replacement log**.
2. Select the "Sensor Cassette removed" activity.
3. Tap the **Send status to printer** button.

To export Sensor Cassette status logs

Prerequisites:

- A USB flash drive

1. Plug in the USB flash drive.
2. Tap **Menu > Data logs > Replacement log**.
3. Select the "Sensor cassette removed" activity.
4. Tap the **Export status logs** button.

Thermal printer paper

To replace the thermal printer paper

Prerequisite:

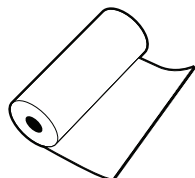

A new roll of thermal printer paper

1. Tap **Menu > Analyzer status**.
2. Tap the **Consumables > Replace > Paper** buttons.
3. Press the release button.

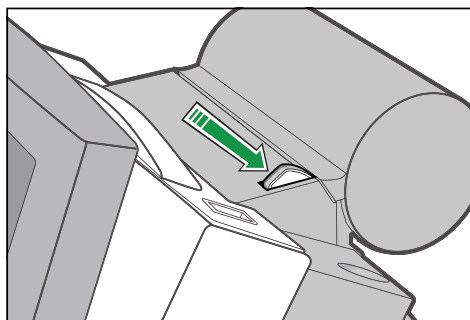

4. Open the cover and remove the used paper roll.
5. Put in the new paper roll. Make sure the paper unwinds from below.
6. Make sure some paper extends out of the printer.
7. Close the cover. The cover must click in place.
8. Tap the **Replaced** button.
9. Enter necessary data.
10. Tap the **OK** button.

Protection of printed data

Note: Do not expose data printed on the thermal printer paper of the analyzer to high temperatures, high humidity, direct sunlight, water, alcoholic or organic solvents, freshly-developed diazo copy sheets or materials that contain polyvinylchloride (PVC), and do not scratch them. Keep the printed data in polyethylene, polypropylene or polyester folders or boxes.

These precautions will help you to protect your printed data.

Inlet Gasket Holder

To replace the Inlet Gasket Holder

Prerequisite:

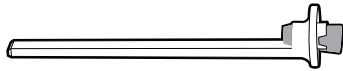

A new Inlet Gasket Holder

⚠ WARNING – Risk of infection

Make sure you do not prick or scratch yourself on the Inlet Probe.

⚠ WARNING – Risk of infection

The used Inlet Gasket Holder has been in contact with blood and must be handled as potentially infectious.

1. Tap **Menu > Analyzer status**.
2. Tap the **Other activities > Inlet check > Repl. Inlet Gasket Holder** buttons.
3. Tap the **Press to start video guidance** button.
4. Pull off the inlet cover.

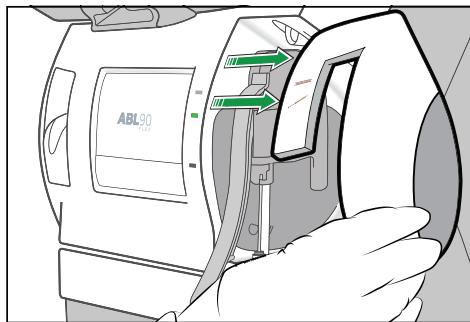

5. Tap the **Action completed** button.
6. Lift the inlet handle to its highest position.

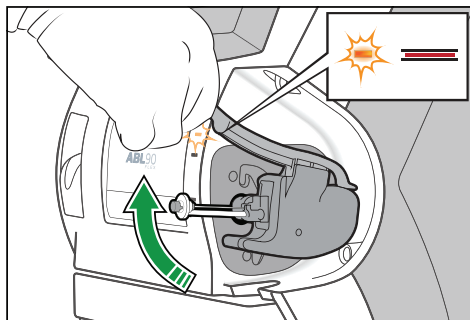

7. Pull out the Inlet Gasket Holder.

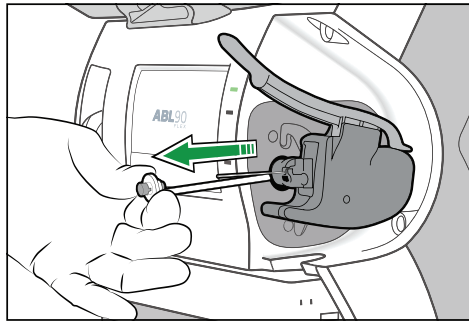

8. Tap the **Action completed** button.
9. Insert the new Inlet Gasket Holder. Make sure that the Inlet Probe is in the center of the gasket.

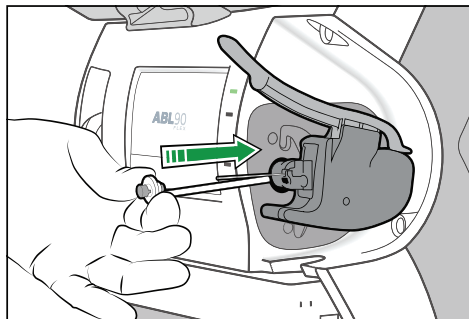

Note: Make sure the Inlet Gasket Holder clicks in place.

10. Tap the **Action completed** button.
11. Close the inlet.
12. Put on the inlet cover.
13. Tap the **Action completed** button.

Inlet Probe

To replace the Inlet Probe

Prerequisite:



A new Inlet Probe

⚠ WARNING – Risk of infection

Make sure you do not prick or scratch yourself on the Inlet Probe.

⚠ WARNING – Risk of infection

The used Inlet Probe has been in contact with blood and must be handled as potentially infectious.

1. Tap **Menu > Analyzer status**.
2. Tap the **Other activities > Inlet check > Repl. inlet probe** buttons.
3. Tap the **Press to start video guidance** button.

4. Pull off the inlet cover.

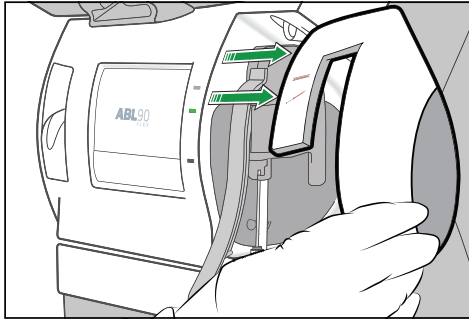

5. Tap the **Action completed** button.
6. Lift the inlet handle to its highest position.

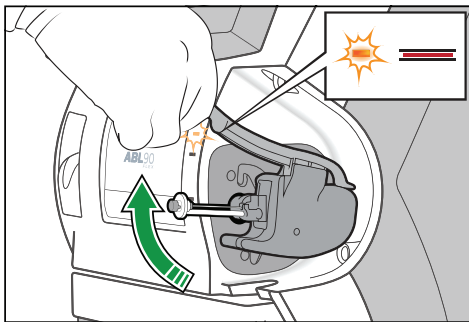

7. Hold the Inlet Module as shown, press your fingers together and pull to the right.

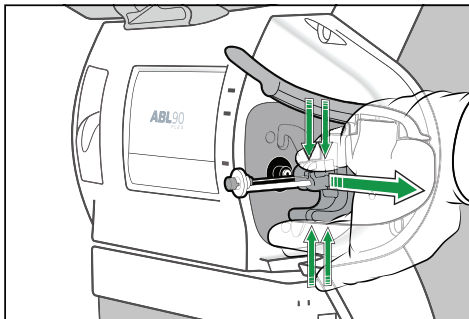

8. Tap the **Action completed** button.

9. Pull out the Inlet Gasket Holder.

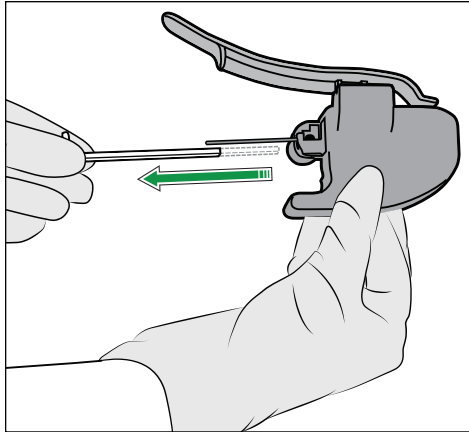

10. Lift up the Inlet Probe as far as it will go and pull it to the right to remove it.

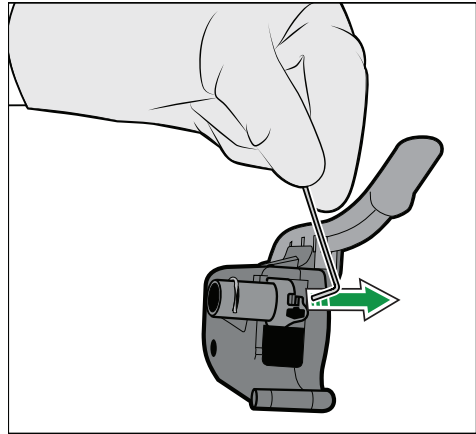
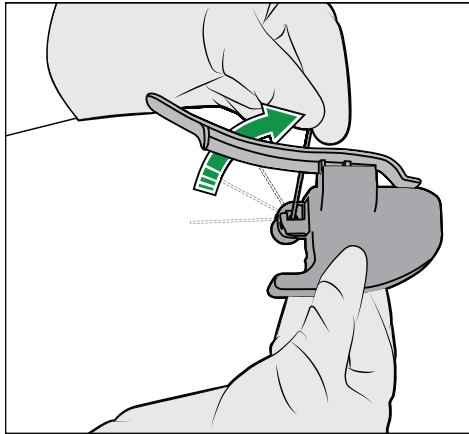

11. Tap the **Action completed** button.

12. Hold the new Inlet Probe in a vertical position and put it in place.

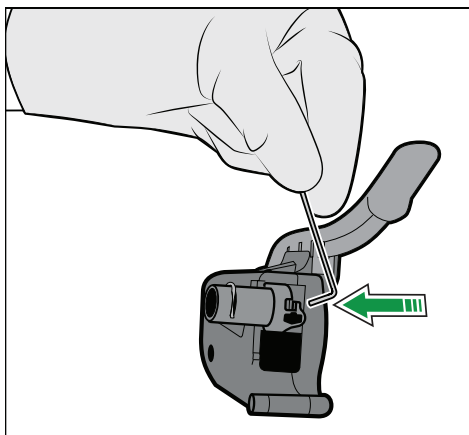

13. Lower the Inlet Probe.

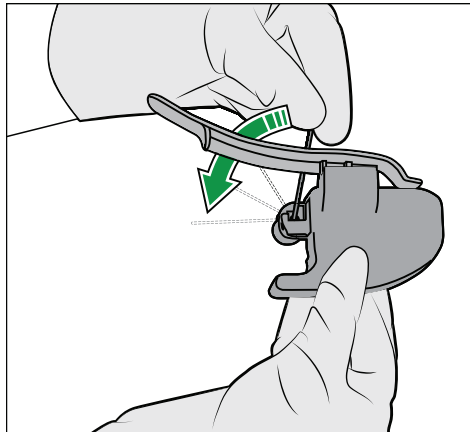

14. Insert the Inlet Gasket Holder. Make sure that the Inlet Probe is in the center of the gasket.

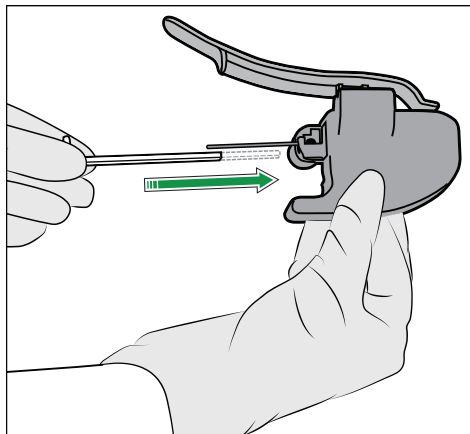

Note: Make sure the Inlet Gasket Holder clicks in place.

15. Tap the **Action completed** button.
 16. Hold the Inlet Module as shown, press your fingers together and push the end into the inlet connector until it clicks in place.

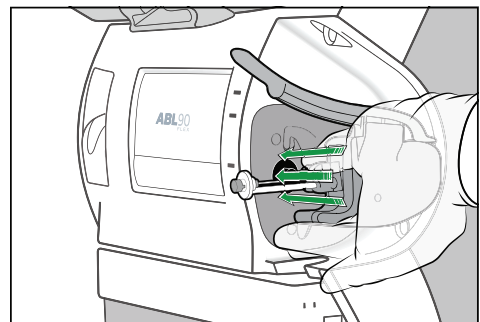
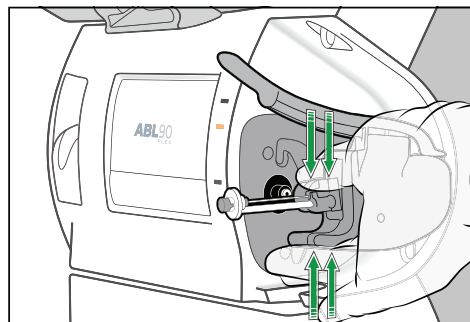

17. Tap the **Action completed** button.
 18. Close the inlet.
 19. Put on the inlet cover.
 20. Tap the **Action completed** button.

Inlet Connector Gasket

To replace the Inlet Connector Gasket

Prerequisites:



A new Inlet Connector Gasket



A pair of tweezers

⚠ WARNING – Risk of infection

The used Inlet Connector Gasket has been in contact with blood and must be handled as potentially infectious.

1. Tap **Menu > Analyzer status**.
2. Tap the **Other activities > Inlet check > Repl. inlet connector gasket** buttons.
3. Tap the **Press to start video guidance** button.
4. Pull off the inlet cover.

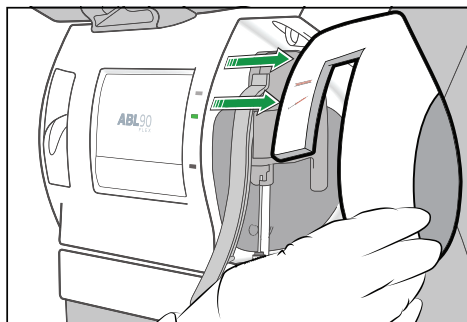

5. Tap the **Action completed** button.
6. Lift the inlet handle to its highest position.

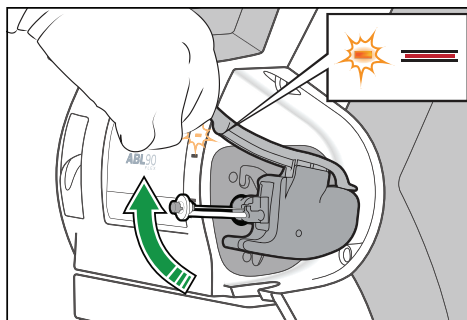

7. Hold the Inlet Module as shown, press your fingers together and pull to the right.

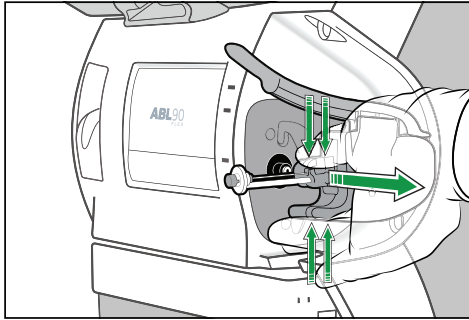

8. Tap the **Action completed** button.
9. Pull out the Inlet Connector Gasket with a pair of tweezers.

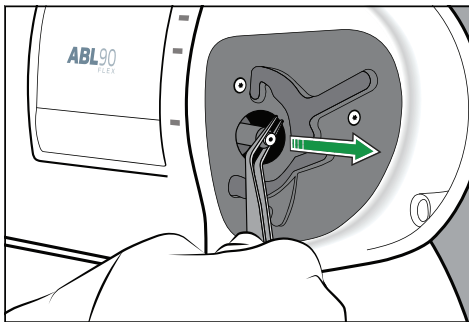

10. Tap the **Action completed** button.
11. Put tap water on the new Inlet Connector Gasket.
12. Tap the **Action completed** button.
13. Push the new Inlet Connector Gasket in place as shown.

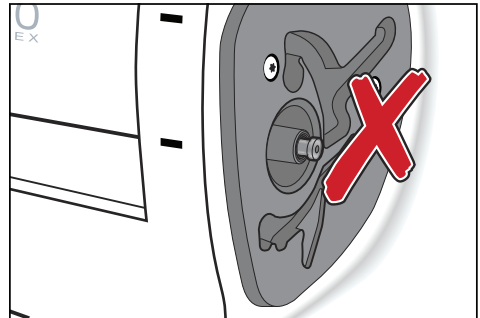
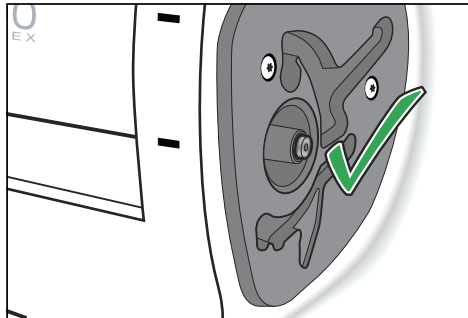

14. Tap the **Action completed** button.

15. Hold the Inlet Module as shown, press your fingers together and push the end into the inlet connector until it clicks in place.

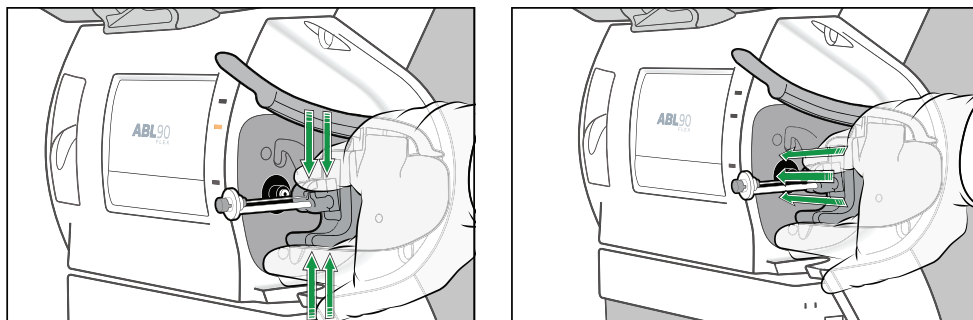

16. Tap the **Action completed** button.
17. Close the inlet.
18. Put on the inlet cover.
19. Tap the **Action completed** button.

Inlet Module

To replace the Inlet Module

Prerequisite:

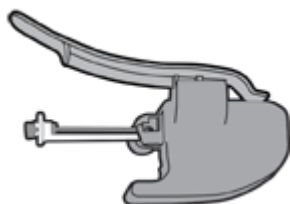

A new Inlet Module

⚠ WARNING – Risk of infection

The used Inlet Module has been in contact with blood and must be handled as potentially infectious.

1. Tap **Menu > Analyzer status**.
 2. Tap the **Other activities > Inlet check > Repl. inlet connector gasket** buttons.
- Note:** Only a new Inlet Module is necessary.
3. Tap the **Press to start video guidance** button.

4. Pull off the inlet cover.

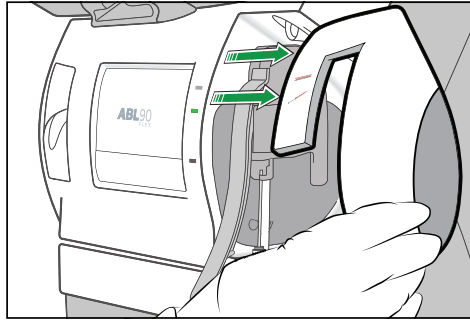

5. Tap the **Action completed** button.
6. Lift the inlet handle to its highest position.

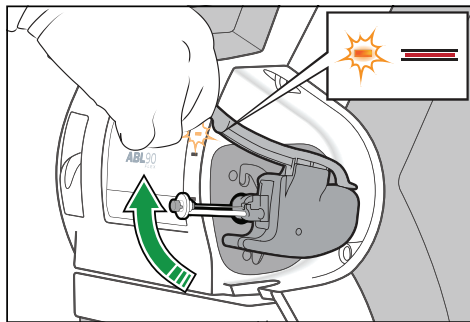

7. Hold the Inlet Module as shown, press your fingers together and pull to the right.

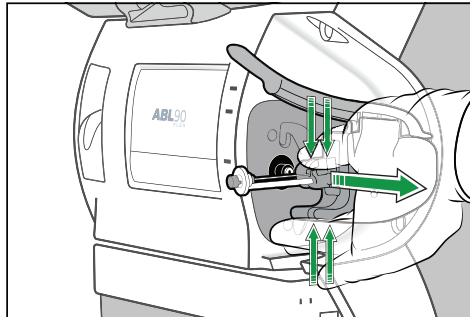

8. Tap the **Action completed** button four times.
9. When the analyzer tells you to, hold the new Inlet Module as shown, press your fingers together and push the end into the inlet connector until it clicks in place.

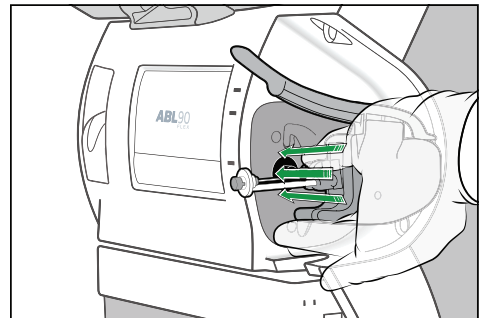
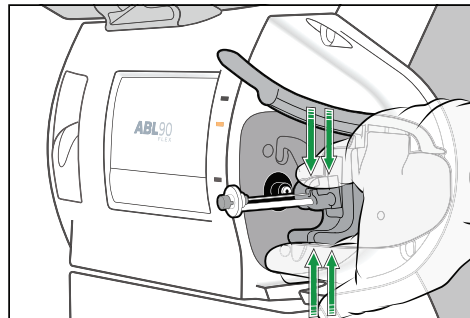

10. Tap the **Action completed** button.

11. Close the inlet.
12. Put on the inlet cover.
13. Tap the **Action completed** button.

Maintenance

Cleaning

Cleaning - when is it necessary?

The analyzer must always be kept clean. Exterior surfaces, the Inlet Gasket and other parts of the analyzer must be cleaned when they are contaminated with blood and/or other liquids.

To clean the inlet gasket

Prerequisite: A lint-free cloth

⚠ WARNING – Risk of infection

Make sure you do not prick or scratch yourself on the Inlet Probe.

1. Tap **Menu > Analyzer status**.
2. Tap the **Other activities > Inlet check > Clean inlet gasket** buttons.
3. Tap the **Press to start video guidance** button.
4. Lift the inlet handle to the capillary position.

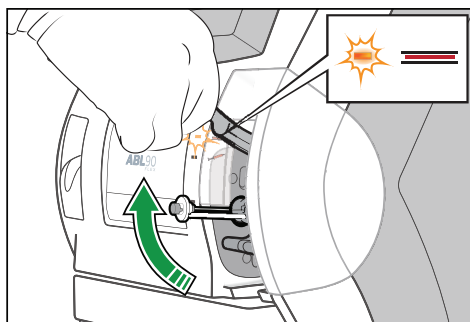

5. Make sure the Inlet Probe is not bent. If it is bent, replace it.
6. Dampen a lint-free cloth with water.
7. Tap the **Action completed** button.
8. Gently wipe the inlet gasket and the area around it until it is clean.
9. Tap the **Action completed** button.
10. Close the inlet.

To clean the Inlet Module

Prerequisites:

- A mild detergent
- Demineralized water
- A lint-free cloth

Note: Do not put cleaning agents into the analyzer.

⚠ WARNING – Risk of infection

Make sure you do not prick or scratch yourself on the Inlet Probe.

⚠ WARNING – Risk of infection

The used Inlet Gasket Holder has been in contact with blood and must be handled as potentially infectious.

1. Tap **Menu > Analyzer status**.
2. Tap the **Other activities > Inlet check > Repl. inlet probe** buttons.

Note: A new Inlet Probe is not necessary.

3. Tap the **Press to start video guidance** button.
4. Pull off the inlet cover.

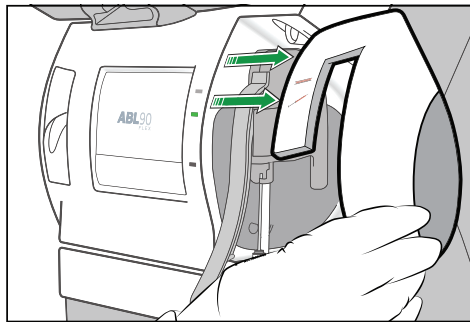

5. Tap the **Action completed** button.
6. Lift the inlet handle to its highest position.

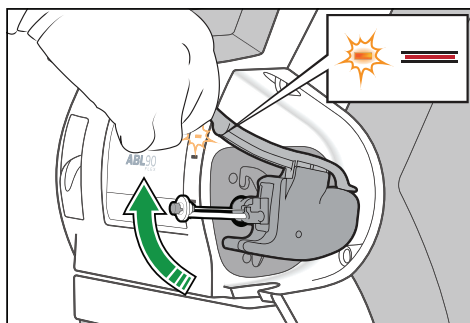

7. Hold the Inlet Module as shown, press your fingers together and pull to the right.

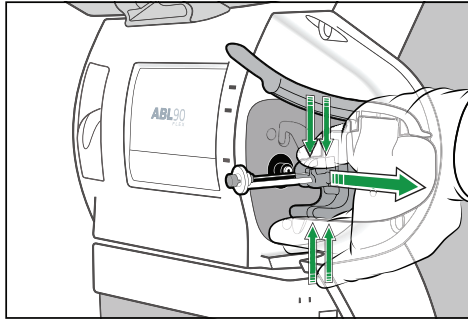

8. Tap the **Action completed** button.
9. Pull out the Inlet Gasket Holder.

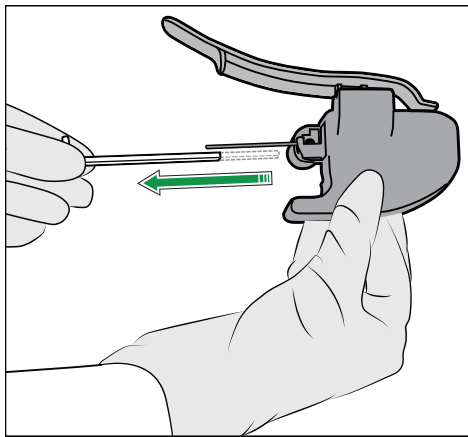

10. Lift up the Inlet Probe as far as it will go and pull it to the right to remove it.

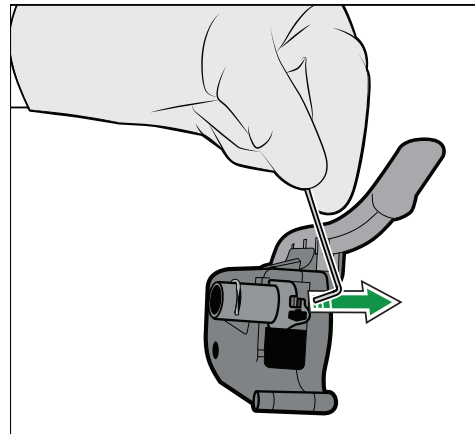
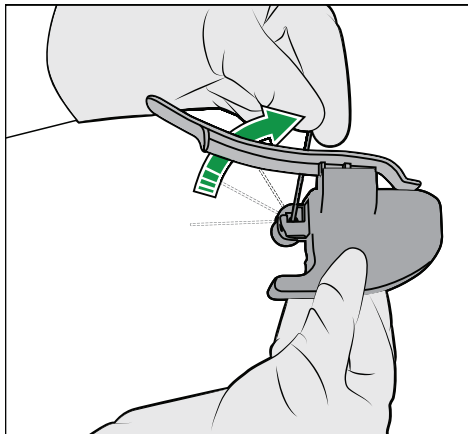

11. Soak the Inlet Gasket Holder and Inlet Probe in the mild detergent solution.
Note: This step is not shown on the screen.
12. Flush the Inlet Gasket Holder and Inlet Probe with demineralized water.
Note: This step is not shown on the screen.
13. Tap the **Action completed** button.

14. Hold the Inlet Probe in a vertical position and put it in place.

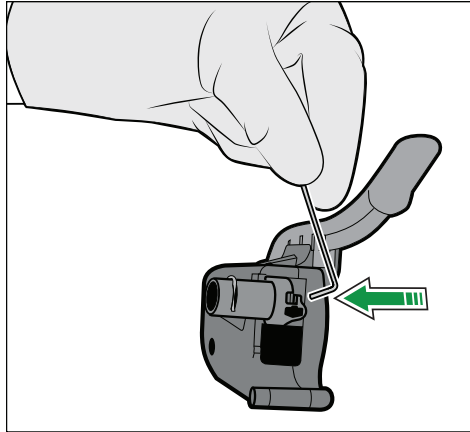

15. Lower the Inlet Probe.

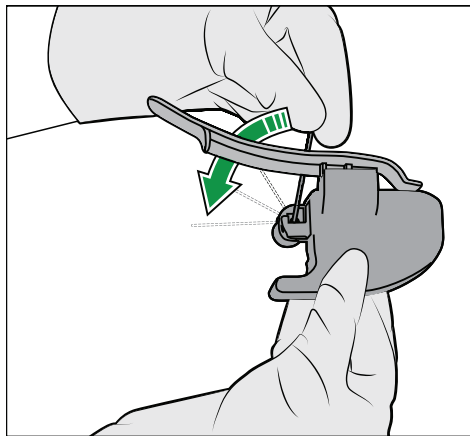

16. Insert the Inlet Gasket Holder. Make sure that the Inlet Probe is in the center of the gasket.

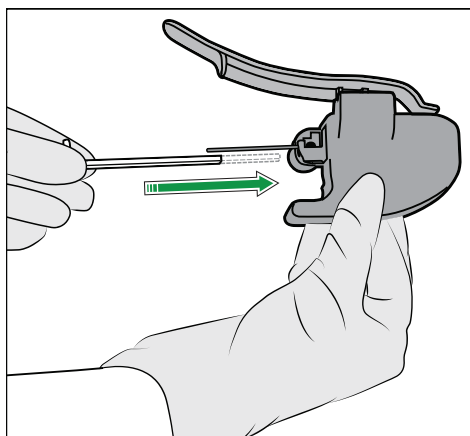

Note: Make sure the Inlet Gasket Holder clicks in place.

17. Tap the **Action completed** button.

18. Hold the Inlet Module as shown, press your fingers together and push the end into the inlet connector until it clicks in place.

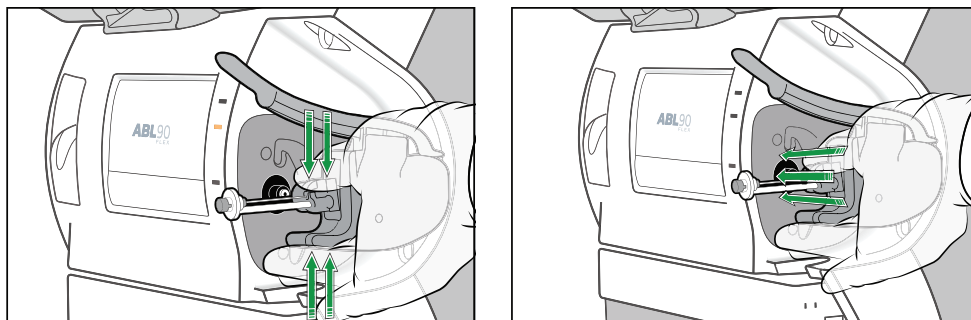

19. Tap the **Action completed** button.
20. Close the inlet.
21. Put on the inlet cover.
22. Tap the **Action completed** button.

To clean the touch screen

Prerequisite: A lint-free cloth

1. Lightly dampen a lint-free cloth with tap water.
2. Put your finger on a part of the screen that is not active and hold it there.
3. Gently wipe the screen.

To clean the analyzer exterior

Prerequisites:

- A lint-free cloth
- A mild soap or detergent

Note: Radiometer has not tested whether cleaning wet wipes can be used for this purpose.

Note: The Sensor Cassette compartment and the top surface of the Solution Pack compartment must be cleaned by a Radiometer representative.

1. Lightly dampen a lint-free cloth with soapy water or a mild detergent.
2. Wipe the analyzer exterior.

Disinfecting

Disinfection - when is it necessary?

Follow your local, state and federal guidelines.

To disinfect the touch screen

Prerequisites:

- The analyzer is clean
- A lint-free cloth
- A solution of 70 % iso-propyl alcohol (2-propanol) or 70 % ethanol

1. Lightly dampen a lint-free cloth with a recommended disinfection solution.
2. Put your finger on a part of the screen that is not active and hold it there.
3. Gently wipe the screen.

To disinfect the analyzer exterior

Prerequisites:

- The analyzer is clean
- A lint-free cloth
- A solution of 70 % iso-propyl alcohol (2-propanol), 70 % ethanol or 5 % sodium hypochlorite

Note: Radiometer has tested that these solutions can be used once a week for 10 years.

Note: Radiometer has not tested whether disinfection wet wipes can be used for this purpose.

Note: The Sensor Cassette compartment and the top surface of the Solution Pack compartment must be disinfected by a Radiometer representatives.

1. Lightly dampen a lint-free cloth with a recommended disinfection solution.
2. Wipe the analyzer exterior.

To disinfect the fluid transport system

1. Do the long-term shutdown procedure.

Battery

To recharge the analyzer battery

1. Connect the analyzer to the mains power supply.

To install and service the battery

1. Contact your local Radiometer representative.

Disposal

To dispose of the analyzer

Contact your local Radiometer representative for instructions.

Inlet Clip

Inlet Clip - when is it necessary to use one?

If a non-Radiometer syringe is used, it may be necessary to install an Inlet Clip. Contact your Radiometer representative for more information.

To put an Inlet Clip on the Inlet Gasket Holder

Prerequisite:



An Inlet Clip

This procedure is only necessary if a non-Radiometer syringe is used. Contact your Radiometer representative for more information.

Note: The Inlet Clip must be removed before ampoule-based QC measurements and when samples are analyzed from sample tubes.

1. Pull off the inlet cover.

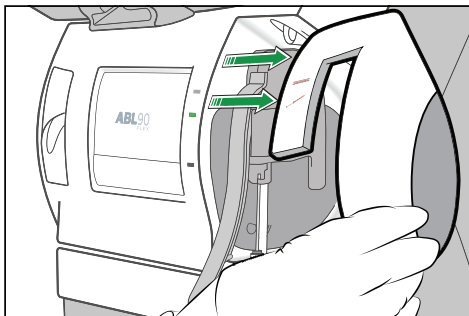

2. Put the open end of the Inlet Clip over the back of the Inlet Gasket Holder as shown and pull it in place.

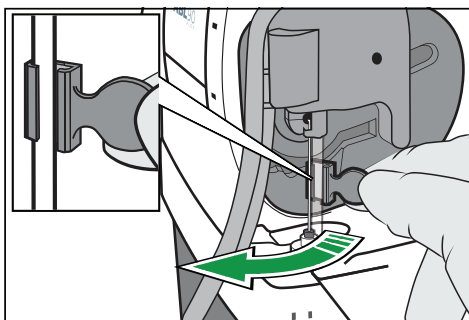

3. Put on the inlet cover.

To remove the Inlet Clip from the Inlet Gasket Holder

Note: The Inlet Clip must be removed before ampoule-based QC measurements and when samples are analyzed from sample tubes.

1. Pull off the inlet cover.

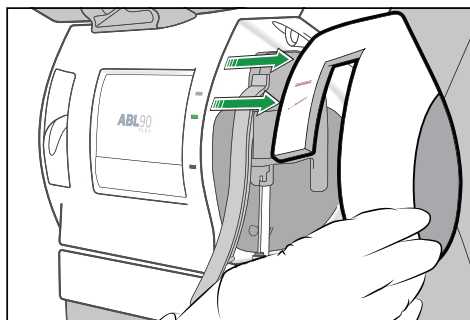

2. Pull off the Inlet Clip from the back of the Inlet Gasket Holder.

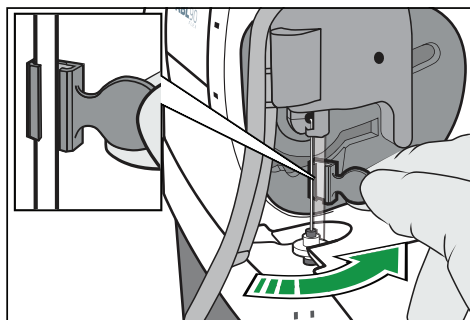

3. Put on the inlet cover.

Connecting peripherals

To connect a USB external keyboard / mouse

Prerequisite: A USB external keyboard/mouse

1. Connect the external keyboard/mouse cable to the external keyboard/mouse port of the analyzer.

Note: The analyzer will find the connection to the external keyboard/mouse immediately.

To connect a non-USB (PS/2) external keyboard or mouse

Prerequisite: A non-USB (PS/2) external keyboard or mouse.

1. Do a temporary shutdown.
2. Connect the external keyboard/mouse cable to the external keyboard/mouse port of the analyzer.
3. Restart the analyzer.

To connect an external barcode reader

1. Contact your local Radiometer representative.

To connect the analyzer to a network

Prerequisite: RJ45 connector.

1. Connect the network cable to the network connector and the network cable port of the analyzer.

Note: If the analyzer is set up for connection to a LIS/HIS or AQUIRE/RADIANCE system, the analyzer will find the network connection immediately.

Reference

1. Clinical laboratory waste management. CLSI/NCCLS document GP5-A2, Clinical Laboratory Standards Institute, 940 West Valley Road, Suite 1400, Wayne, Pennsylvania 19087-1898 USA.

Overview of quality control management

Quality control management is important as it evaluates the performance of the analyzer to make sure that the patient results are accurate and precise.





The analyzer manages quality control automatically, but if local, federal or state regulations require additional quality control procedures, operators can do them.

To find the status of QC measurements

1. Tap **Menu > Analyzer status**.
2. Tap the **Quality control** button.

Note: A symbol in the **Solution** column shows the status of a QC measurement.

Symbols that show the status of QCs

Symbol	Indication
	The QC measurement was completed successfully
	An error was found on one or more QC result
	A scheduled QC measurement is pending. The last QC was completed successfully.
	A scheduled QC measurement is pending. The last QC was not completed successfully.

Automatic quality control management

About automatic quality control management

Automatic quality control management (AQM) is the name given to quality control procedures that the analyzer is programmed to do automatically.

Automatic quality control management	
Name of the procedure	Description
System checks	Automatic test sequences done with each measurement and at other times to make sure that all parts of the analyzer operate within specifications.

Automatic quality control management	
Name of the procedure	Description
Built-in QC	<p>These are liquid QC measurements that are automatically done by the analyzer.</p> <p>The 3 QC solutions in the Solution Pack are used for these measurements.</p>
Apply statistical rules to QC results.	<p>Helps operators to find errors, shifts, and trends. Symbols on results show when rules are violated.</p> <p>For example: Westgard Rules and RiLiBÄK rules (used in Germany).</p> <p>Note: The analyzer must be set up to do this.</p>
Apply corrective action for QC errors	<p>The default corrective action for QC errors:</p> <ul style="list-style-type: none"> • The color of the traffic light adjacent to the Quality control button in the Analyzer status screen changes to yellow • The parameter tab changes to yellow • The ? symbol will be shown on the parameter in patient results <p>Note: The default settings can be changed.</p>
Repress a parameter if there are any problems	<p>Note: The analyzer must be set up to do this.</p> <ul style="list-style-type: none"> • Patient results will not include results for parameters with QC errors • The parameter tab changes to red
Lock the analyzer until requested ampoule-based QC measurements are done after a Solution Pack and/or Sensor Cassette replacement	<p>Note: The analyzer must be set up to do this.</p> <p>Note: Patient samples cannot be analyzed while the analyzer is locked.</p>

Related information

To set up and enable Westgard Rules, page 188

To add a new RiLiBÄK rule, page 189

To repress a parameter, page 170

To set up corrective action for errors in QC results, page 184

To request ampoule-based QC measurements after replacements, page 184

About system checks

Automatic test sequences done with each measurement and at other times to make sure that all parts of the analyzer operate within specifications.

The analyzer automatically takes action to correct a problem it finds. If the action fails, a message is shown and the analyzer goes into the **Operator Action Needed, Troubleshooting needed** or **Intervention Required** mode. In these modes operators are given instructions about what to do.

Results of failed system checks are recorded in the **Activity log**.

Overview of automatic quality management

Here is an overview of the default schedule for system checks, QC and calibration measurements that the analyzer does to make sure that patient results are accurate, precise and reliable.

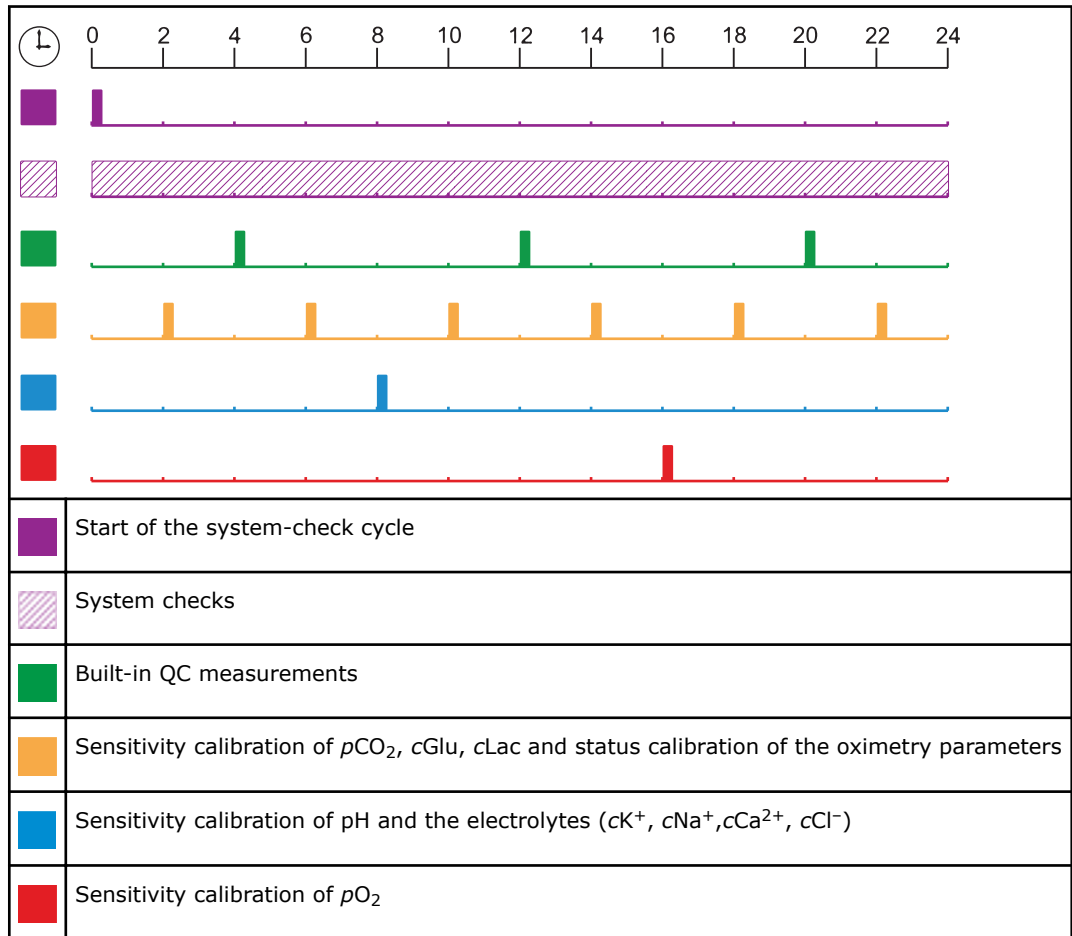

A status calibration of all parameters (except the oximetry parameters) is done before every patient, QC and sensitivity calibration measurement.

Related information

Details about calibration frequency, page 175

Built-in QC

About built-in QC measurements

The analyzer uses the three levels of QC solution contained in the Solution Pack to do built-in QC measurements. These QC solutions are automatically registered in slots A, B and C when a Solution Pack is installed.

Note: The solution in slot A is S9030, the solution in slot B is S9040 and the solution in slot C is S9050.

Built-in QC measurement frequency

A built-in QC measurement is scheduled by default to be done every 8 hours. One measurement a day is done with each QC solution. Built-in QC measurements are also scheduled by default to be done in connection with these activities:

- Replacement of the Solution Pack
- Replacement of the Sensor Cassette
- Startup

You can edit the schedule for built-in QC measurements.

To request an unscheduled built-in QC measurement

Prerequisite: Make sure that the analyzer is **Ready**.

1. Tap **Menu** > **Analyzer status** > **Quality control**.
2. Select a QC solution in the **Built-in QC** field.
3. Tap the **Start QC** button.
The result of the QC measurement is saved in the **Quality control log**.

Built-in QC results

Status of built-in QC measurements

The symbols in the **Solution** column of the **Quality control** part of the **Analyzer status** screen shows the overall status of each QC measurement.

Symbol	Description
✓	The QC measurement was successful
?	An error was found on one or more parameter result.

To find a built-in QC result

1. Choose an option and follow the steps for it.





Option	Steps
To find a result in the data log	<ol style="list-style-type: none"> a) Tap Menu > Data logs > Quality control log. b) Select the measurement. Note: Built-in QC measurements are done with solutions in slots A, B and C. c) Tap the Result button.
To find a number of results in the data log	<ol style="list-style-type: none"> a) Filter the data from the Quality control log.
To find the latest result	<ol style="list-style-type: none"> a) Tap Menu > Analyzer status > Quality control. b) In the Built-in QC field, select the measurement. c) Tap the Result button.

Related information

To filter data from the Quality control log, page 81

Symbols on built-in QC results

Problems on built-in QC results are marked with one or more of the symbols shown in the table.

Symbol	Description
	An error was found. A message attached to the result describes the error.
	The result is outside the control range, but inside the statistical range. Results inside the statistical range are included in statistics.
	The result is outside the statistical range. The result is not included in statistics
	The result is outside the range of indication*. The result is not included in statistics
.....	The result could not be calculated. When possible, an interpretation of the message is attached.
*	Operator-defined slope/offset corrections were used to calculate the result
W	The result violates a Westgard rule
R	The result violates a RiliBÄK rule

* The Range of indication is the range the analyzer is capable of measuring and includes values outside the Reportable range. The performance of the analyzer outside the Reportable range specified in the *Specifications* chapter has not been validated. Only results within the Reportable range should be reported.

To see messages on built-in QC results

1. Tap **Menu** > **Data logs** > **Quality control log**.
2. Select the measurement.
Note: QC solutions used for built-in QC measurements are automatically registered in slots A, B and C.
3. Tap the **Result** button.
4. Tap the **Messages** button.

To troubleshoot messages on built-in QC results

Prerequisite: You can see the message you want to troubleshoot.

1. Select the message.
2. Tap the **Troubleshoot** button.
3. Follow the instructions on the screen.

Quality control management done by operators

Quality control management that can be done by operators

The analyzer manages quality control automatically, but if local, federal or state regulations require additional quality control (QC) procedures, they can be done. These procedures are called ampoule-based QC measurements.

QC procedures	Description
Ampoule-based QC measurements	Manual QC measurements done with QC ampoules Note: If local, federal or state regulations require that analyzer-specific control ranges be established for the QC solutions used for ampoule-based QC measurements, it can be done.
Ampoule-based QC measurements after Solution Pack and/or Sensor Cassette replacements	The analyzer is locked until requested ampoule-based QC measurements are done. Note: The analyzer must be set up to do this.
Calibration verification measurements (for example in the USA).	Measurements that let you verify the calibration and reportable range of measured parameters Note: This procedure requires control material to be analyzed as patient samples.

Related information

To do an ampoule-based QC measurement, page 71

About calibration verification, page 74

To request ampoule-based QC measurements after replacements, page 184

Ampoule-based QC measurements

QC solutions for ampoule-based measurements

Radiometer recommends that Radiometer QUALICHECK5+ solutions are used for ampoule-based QC measurements. Four levels of QUALICHECK5+ solutions are available.

Note: If non-Radiometer QC solutions are used, Radiometer cannot guarantee accurate, valid QC results.

How to get good ampoule-based QC measurement results

To get good ampoule-based QC measurement results, follow the listed advice.

- For Radiometer solutions only:
 - Check that there are no calibration errors before you do an ampoule-based QC measurement.
 - Keep the QC solution under the correct storage conditions. See the product insert.
 - Hold the ampoule between the thumb and first finger when you shake it.
 - Shake the ampoule vigorously for 15 seconds before it is opened.
 - Use the Radiometer QUALICHECK adapter to hold the ampoule during the QC measurement.
 - Use the prepared QC solution immediately after the ampoule is opened.
 - Use the ampoule for one QC measurement only.
 - Enter the correct ampoule temperature in the **Quality control identification** screen during the QC measurement.
- For non-Radiometer QC solutions:

- Check that there are no calibration errors before you do an ampoule-based QC measurement.
- Keep the QC solution under the correct storage conditions. See the product insert.
- Prepare the QC solution for use correctly. Follow the manufacturer's instructions.

To prepare a Radiometer QC ampoule for use

Prerequisites:



A QUALICHECK5+ ampoule



An Ampoule Opener



A QUALICHECK Adapter

Note: The Radiometer QUALICHECK5+ box that contains the QC ampoules has been stored at a constant temperature (18-32 °C) for 5 hours.

Note: If there are errors on calibration results, they will be shown on the ampoule-based QC results.

1. Remove a QC ampoule from its box.
2. Put the lid back on the box.
The ampoules are sensitive to light.
3. Hold the ampoule between your thumb and first finger and shake it vigorously for a minimum of 15 seconds.
4. Hold the ampoule neck-side up and tap the top until all the solution collects in the lower part of the ampoule.
5. Put the ampoule in the Ampoule Opener.

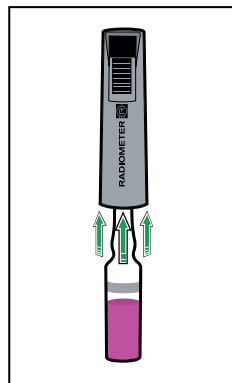

6. Use your fingers to apply pressure in the directions shown, to break off the neck of the ampoule.

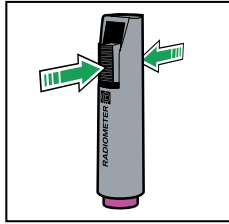

7. Gently pull the ampoule out of the Ampoule Opener.
8. Put the QUALICHECK Adapter over the open end of the ampoule.

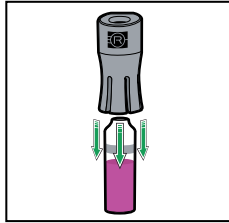

9. Do an ampoule-based QC measurement immediately.

Related information

Quality control products - code numbers, page 386

To do an ampoule-based QC measurement

Prerequisites:

- The QC solution is registered for use on the analyzer
- The QC ampoule is prepared for use
- No Inlet Clip is installed on the Inlet Gasket Holder
- Make sure that the analyzer is **Ready**

Note: If there are errors on calibration results, they will be shown on the ampoule-based QC results.

Note: The insert control ranges of Radiometer QC solutions are determined at a reference temperature of 25 °C. It is therefore important to enter the correct ampoule temperature during QC measurements so the analyzer can temperature correct QC results.

If the correct temperature is not entered, this will have an effect on pH, $p\text{CO}_2$ and $p\text{O}_2$ results. At temperatures above 25 °C, pH results will be too high and $p\text{CO}_2$ and $p\text{O}_2$ will be too low. At temperatures below 25 °C, pH will be too low and $p\text{CO}_2$ and $p\text{O}_2$ results will be too high.

Note: Radiometer QC ampoules are for single use only.

1. Hold the QC adapter with the QC ampoule and lift the inlet handle to the syringe position.

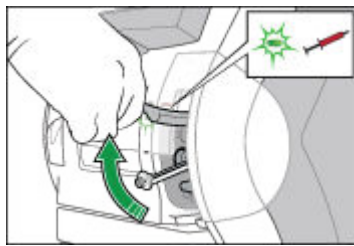

2. Tap the **Ampoule - QC** button.
3. Turn the QUALICHECK Adapter with the ampoule so the Radiometer logo faces upwards.
4. Put the QUALICHECK Adapter with the ampoule over the inlet gasket.
5. Push the adapter with the ampoule into the analyzer as far as it will go and hold it there.

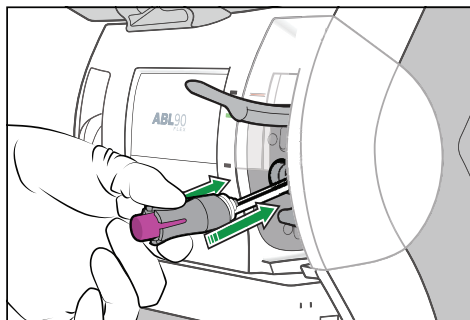

6. Hold the adapter with the ampoule in the pushed-in position until the analyzer tells you to remove it.

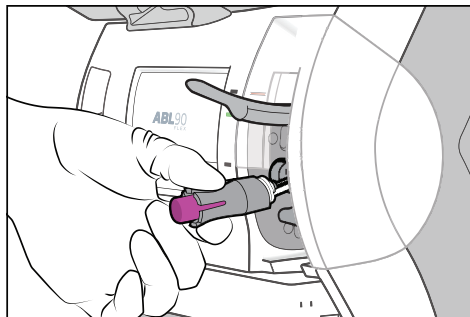

7. When the analyzer tells you to, remove the QUALICHECK adapter with the ampoule.
8. Close the inlet.
9. Make sure the **Solution:** field is selected.
10. Make sure that there is only one lot of the QC solution.

Note: QC solutions are identified by a **Solution** name (for example S7730) and a **Lot** number.
11. If there is only one lot, go to step 13.
12. If there is more than one lot, select the correct lot of QC solution.
13. Enter the ampoule temperature.

Note: It is important to enter the correct temperature. See the note above.
14. Enter other necessary data in the **Quality control identification** screen.
15. Tap the **Result** button.
16. Remove the ampoule from the adapter and discard the ampoule as biohazardous waste.

Related information

To register a Radiometer QC solution for ampoule-based QC measurements, page 178

To request an unscheduled calibration from the Analyzer status screen, page 87

To request an unscheduled calibration from the Analyzer status screen, page 87

To edit QC identification data

Note: You can only edit the **Department**, **Operator** and **Note** fields.

1. Tap **Menu** > **Data logs** > **Quality control log**.
2. Select a measurement done with the QC solution you want to edit.

Note: QC solutions are identified by a **Solution** name (for example, S7730) and **Lot** number.
3. Tap the **Result** button.
4. Tap the **QC ID** button.
5. Edit the necessary data.

Ampoule-based QC results

Status of ampoule-based QC measurements

The symbols in the **Solution** column of the **Quality control** part of the **Analyzer status** screen shows the overall status of each QC measurement.

Symbol	Description
✓	The QC measurement was successful
?	An error was found on one or more parameter result.

To find an ampoule-based QC result

1. Tap **Menu > Data logs > Quality control log.**
2. Select the solution.
3. Tap the **Result** button.

Symbols on ampoule-based QC results

Problems on ampoule-based QC results are marked with one or more of the symbols shown in the table.

Symbol	Description
?	An error was found. A message attached to the result describes the error.
↑↓	The result is outside the control range, but inside the statistical range. Results inside the statistical range are included in statistics.
↑↓↑↓	The result is outside the statistical range. The result is not included in statistics.
↑↓↑↓↑↓	The result is outside the range of indication*. The result is not included in statistics.
.....	The result could not be calculated. When possible, an interpretation of the message is attached.
*	Operator-defined slope/offset corrections were used to calculate the result
W	The result violates a Westgard rule
R	The result violates a RiliBÄK rule

* The Range of indication is the range the analyzer is capable of measuring and includes values outside the Reportable range. The performance of the analyzer outside the Reportable range specified in the *Specifications* chapter has not been validated. Only results within the Reportable range should be reported.

To see messages on ampoule-based QC results

1. Tap **Menu > Data logs > Quality control log.**
2. Select the solution.
3. Tap **Result** button.
4. Tap the **Messages** button.

To troubleshoot messages on results

Prerequisite: You can see the message you want to troubleshoot.

1. Select the message.
2. Tap the **Troubleshoot** button.
3. Follow the instructions on the screen.

Calibration verification

About calibration verification

Some local, state or federal regulations require calibration verification to be done (for example, in the USA). Calibration verification is a process that lets you verify the calibration and reportable range of the parameters measured by the analyzer.

Calibration verification is a 3-stage process:

- **Stage 1:** Analyze as patient samples a minimum of three different levels of QC solution.
Note: On the analyzer, these measurements are referred to as calibration verification measurements.
- **Stage 2:** Use the calibration-verification measurement results to verify the calibration and reportable range of the measured parameters. Follow your local, state and federal guidelines.
- **Stage 3:** If necessary, change the reportable range of parameters.

Related information

To set up reportable ranges, page 161

Frequency of calibration verification

Follow your local, state or federal regulations.

Stage 1 - Analyzing different levels of control solution

To prepare a Radiometer calibration-verification ampoule for use

Prerequisites:



A calibration-verification ampoule



An Ampoule Opener



A QUALICHECK Adapter

Note: The Radiometer box that contains the QC ampoules for calibration verification has been stored at a constant temperature (18-32 °C) for 5 hours.

Note: If there are errors on calibration results, they will be shown on the calibration-verification results.

1. Remove a calibration-verification ampoule from its box.
2. Put the lid back on the box.
The ampoules are sensitive to light.
3. Hold the ampoule between your thumb and first finger and shake it for a minimum of 15 seconds.
4. Hold the ampoule neck-side up and tap the top until all the solution collects in the lower part of the ampoule.
5. Put the ampoule in the Ampoule Opener.

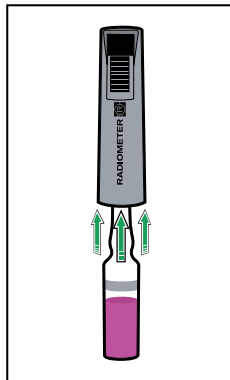

6. Use your fingers to apply pressure in the directions shown, to break off the neck of the ampoule.

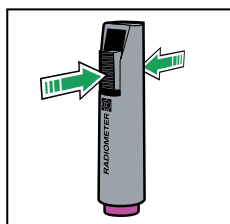

7. Gently pull the ampoule out of the Ampoule Opener.

8. Put the QUALICHECK Adapter over the open end of the ampoule.

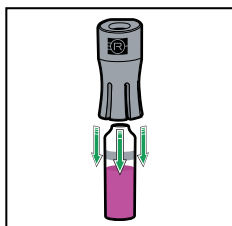

9. Do a calibration-verification measurement immediately.

Related information

Quality control products - code numbers, page 386

To do a calibration-verification measurement

Prerequisites:

- A calibration-verification mode has been set up
- The calibration-verification control solution is prepared for use
- Make sure that the analyzer is **Ready**

Note: Radiometer calibration-verification ampoules are for single use only.

1. Lift the inlet handle to the syringe position.

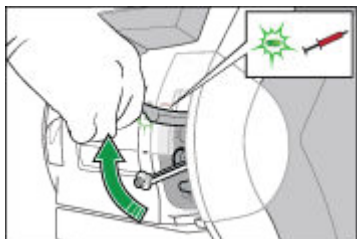

2. Tap the **Cal. Verification** button.
3. Turn the QUALICHECK Adapter with the ampoule so the Radiometer logo faces upwards.
4. Put the QUALICHECK Adapter with the ampoule over the inlet gasket.
5. Push the adapter with the ampoule into the analyzer as far as it will go and hold it there.

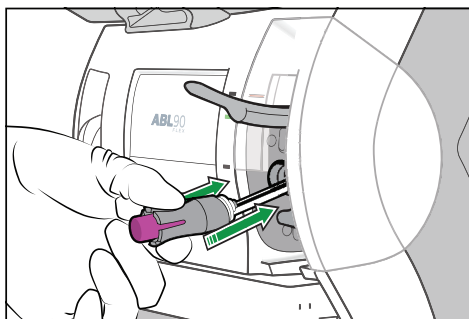

6. Hold the adapter with the ampoule in the pushed-in position until the analyzer tells you to remove it.

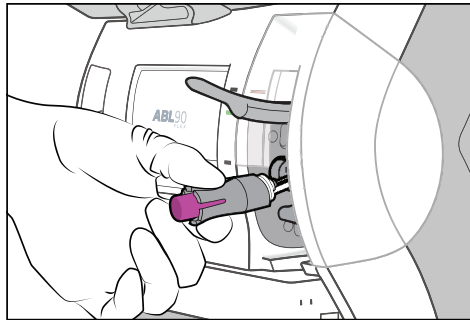

7. When the analyzer tells you to, remove the adapter with the ampoule.
8. Close the inlet.
9. Enter enough information to identify the calibration-verification control solution in the **Patient ID** field.
Note: Enter a maximum of 20 characters. If more are entered they will not be sent to LIS/HIS and/or AQUIRE/RADIANCE systems.
10. If necessary, enter a note.
11. Tap the **Result** button.
Note: Results are not temperature-corrected. If the ampoule temperature was not 25 °C, you must temperature-correct the results manually. Results are saved in the **Patient results log**.
12. Remove the ampoule from the adapter and dispose of it as biohazardous waste.

Post-requisite: Do calibration-verification measurements with a minimum of 3 levels of calibration-verification control solution.

Related information

To set up a calibration-verification mode, page 156

To temperature correct calibration-verification results based on Range+ QUALICHECK measurements, page 78

Stage 2 - Using results to verify reportable ranges

To find a calibration-verification measurement result

Calibration-verification results are saved in the **Patient result log**. The results are identified as "Cal. Verification" in the **Sample type** column.

Note: Results for pH, pCO_2 and pO_2 must be corrected if the temperature of the ampoule during the measurement was above or below 25 °C.

1. Tap **Menu > Data logs > Patient results log**.
2. Tap the **Filter** button.
3. In the **Criteria** frame, choose an option and follow the steps for it.

Option	Steps
To select a time period prior to today's date	Tap the number button for the number of days you want
To select a start and end date	Enter data in the Start date: and End date: fields

4. For **Sample type**, select "Cal. Verification".
5. Tap the **Apply** button.

6. Select the measurement.

7. Tap the **Result** button.

Note: The result must be temperature corrected.

Symbols on calibration-verification measurement results

Problems on calibration-verification results are marked with one or more of the symbols shown in the table.

Symbol	Description
?	An error occurred. A message attached to the result describes the error
↑↑	The result is above the upper limit of the reportable range
↓↓	The result is below the lower limit of the reportable range
.....	No result could be calculated or the result is outside the range of indication* of the analyzer
*	Operator-defined correction factors were used to calculate the result

* The Range of indication is the range the analyzer is capable of measuring and includes values outside the Reportable range. The performance of the analyzer outside the Reportable range specified in the *Specifications* chapter has not been validated. Only results within the Reportable range should be reported.

To temperature correct calibration-verification results based on Range+ QUALICHECK measurements

Note: Results for pH, $p\text{CO}_2$ and $p\text{O}_2$ must be corrected if the temperature of the ampoule during measurements was above or below 25 °C.

1. Find the temperature constant (A) in the table.

Radiometer calibration-verification control solutions (Range+ QUALICHECK products)		
Parameter	Temperature constants (A)	
	Level 1	Level 2
pH	0.0013	0.0026
$p\text{CO}_2$	-0.0056	-0.0071
$p\text{O}_2$	-0.0098	-0.0107

Note: It is not necessary to temperature correct the results for Range+ QUALICHECK solution level 3.

2. Use the equations in the table to correct results for parameters that were measured at temperatures above or below 25 °C.

Parameter	Equation for temperature correction
pH	$\text{pH}_{\text{corrected to 25 °C}} = \text{pH}_{\text{measured}} - A (t - 25)$
$p\text{CO}_2$	$(p\text{CO}_2)_{\text{corrected to 25 °C}} = (p\text{CO}_2)_{\text{measured}} \times [1 - A (t - 25)]$

Parameter	Equation for temperature correction
pO ₂	$(pO_2)_{\text{corrected to } 25\text{ }^\circ\text{C}} = (pO_2)_{\text{measured}} \times [1 - A (t - 25)]$

Example:

The pH calibration-verification measurement result was 7.100 for a level 1 solution. The temperature of the ampoule during the measurement was 32 °C not 25 °C. The result must therefore be corrected.

The temperature constant for a level 1 solution for pH is 0.0013.

The equation for temperature correction of pH values is:

$$pH_{\text{corrected to } 25\text{ }^\circ\text{C}} = pH_{\text{measured}} - A (t - 25) = 7.100 - 0.0013 (32 - 25) = 7.091$$

To use temperature-corrected calibration-verification results

Prerequisites: Temperature corrected calibration-verification results

1. Use the results to verify the reportable range of all measured parameters. Follow your local, state or federal guidelines.

Stage 3 - Changing reportable ranges**To change the reportable range of parameters**

Prerequisites: New reportable ranges established during calibration verification.

1. Tap **Menu** > **Utilities** > **Setup** > **Analysis setup** > **Reportable ranges**.
2. Select the parameter in the **Parameters** field.
3. Enter new values for the upper and lower limits of the reportable range.
4. If necessary, do steps 2 and 3 again for each parameter.
5. Tap the **Close** button.

Reviewing QC statistics**To find and print QC statistics**

Only QC results that are within the statistical range are included in the QC statistics.

Note: You can only print QC statistics for one month at a time.

1. Tap **Menu** > **Data logs** > **Quality control log**.
2. Tap the **Statistics** button.
3. Tap the **Next param.** or **Prev. param.** button to see statistics for other parameters.

4. Tap the **Print** button.
5. Choose an option and follow the steps for it.

Option	Steps
To print statistics for the lot to date	<ul style="list-style-type: none"> • Select the Print lot-to-date check button. • Tap the Print button. <p>Note: This option is only available when a minimum number of QC measurements have been done.</p>
To print statistics for a period	<ul style="list-style-type: none"> • Select the Print for period check button. • Select the calendar month period in the Print for period frame. • Tap the Print button.

Note: QC statistics are printed for all parameters.

Related information

Glossary of quality control terms, page 177

QC plots

QC plots are Levey-Jennings plots that show QC results done with registered QC solutions. The results are shown on a horizontal time axis.

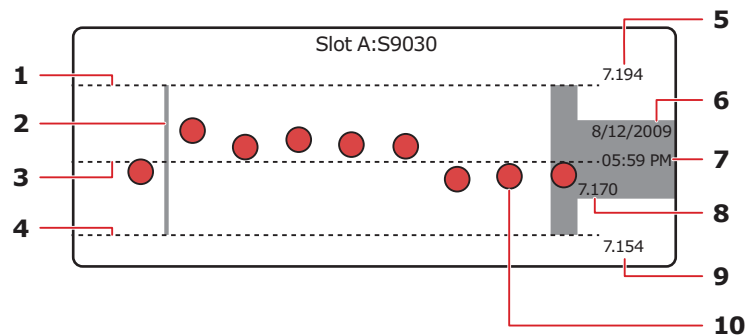

- | | |
|--|--|
| <p>1 Line to show the upper limit of the control range of the solution</p> <p>2 Line to show when the current control range of the solution was changed, or a new lot of the QC solution was registered</p> <p>3 Mean value of the control range of the solution</p> <p>4 Line to show the lower limit of the control range of the solution</p> <p>5 The absolute value of the upper limit of the control range of the solution</p> | <p>6 Date that the highlighted QC measurement was done</p> <p>7 Time that the highlighted QC measurement was done</p> <p>8 QC result for the selected QC measurement</p> <p>9 The absolute value of the lower limit of the control range of the solution</p> <p>10 A previous QC measurement done with the solution</p> |
|--|--|

To find a QC plot

1. Tap **Menu > Data logs > Quality control log**.
2. Tap the **Plot** button.
3. Select a parameter.
4. Tap the **Ampoule QC <number...>** button to see plots for ampoule-based QC measurements.
5. Tap within the plot for a specific QC solution.
6. Use the scroll buttons to select and see details about specific QC measurements.

To filter data from the Quality control log

1. Tap **Menu > Data logs > Quality control log**.
2. Tap the **Filter** button.
3. In the **Criteria** frame, choose an option and follow the steps for it.

Option	Action
To select a time period prior to today's date	Tap the number button for the number of days you want.
To select a start and end date	Enter data in the Start date: and End date: fields.

4. Select the **Solution**.
5. Select the **Lot**.
6. If necessary, select other criteria.
7. Tap the **Apply** button.

To see trends in QC results

Prerequisite: You have filtered the QC results from the **Quality control log**.

1. Tap the **Trend** button.
2. Select check buttons for the parameters you want to see trends of.
3. Tap the **View trend** button.

WDC file export

About WDC

WDC is the abbreviation for Worldwide DATACHECK system. You can send a WDC file to Radiometer's QA Portal, where you can compare the performance of your analyzer with the performance of the same type of analyzer in various peer groups.

For more information on Worldwide Data Check, see *QA Portal Operator's manual*.

To export WDC files

Prerequisites:

- A storage device (for example, a USB flash drive or an external network)
- A folder for the monthly statistics has been created on the device

This procedure lets you export monthly quality control data to the QA Portal. The data is saved as a comma-separated file (a .csv file).

1. Connect the storage device to the analyzer.
2. Tap **Menu** > **Utilities** > **Disk functions** > **WDC report**.
3. Tap the button in the **Destination** frame.
4. Select the folder where the QC statistics are to be exported.
5. Tap the **Back** button.
6. Select the monthly period.
7. Give the file a name.

Note: All files names start with WDC_. You can only change the 4 characters that follow.

8. Tap the **Export data** button.
If it is not possible to export the selected data, a pop-up message will be shown.

Analyzing QC solutions in other modes

About analyzing QC solutions in other modes

QC solutions may be analyzed in other modes than the **Ampoule - QC** mode. However, when this is done, the results must be temperature-corrected manually.

To temperature correct results based on QUALICHECK5+ solutions

Note: Results for pH, $p\text{CO}_2$ and $p\text{O}_2$ must be corrected if the temperature of the ampoule during measurements was above or below 25 °C.

1. Find the temperature constant (A) in the table.

Radiometer QUALICHECK5+ quality control solutions				
Parameter	Temperature constants (A)			
	Level 1 – S7730	Level 2 – S7740	Level 3 – S7750	Level 4 – S7760
pH	0.0018	0.00113	0.000703	0.00163
$p\text{CO}_2$	0.00482	0.00231	0.000676	0.00657
$p\text{O}_2$	0.00982	0.00986	0.00915	0.0107

2. Find the temperature constant (B) in the table.

Radiometer QUALICHECK5+ quality control solutions				
Parameter	Temperature constants (B)			
	Level 1 – S7730	Level 2 – S7740	Level 3 – S7750	Level 4 – S7760
pH	0.0000220	0.0000180	-0.0000260	0.0000209
$p\text{CO}_2$	0.0000617	0.0000394	0.0000195	0.000117

Radiometer QUALICHECK5+ quality control solutions				
Parameter	Temperature constants (B)			
	Level 1 – S7730	Level 2 – S7740	Level 3 – S7750	Level 4 – S7760
pO ₂	-0.0000327	-0.000115	0.0000177	-0.00000876

3. Use the equations in the table to correct results for parameters that were measured at temperatures above or below 25 °C.

Parameter	Equation for temperature correction
pH	$pH_{\text{corrected to 25 °C}} = pH_{\text{measured}} - A (t - 25) - B(t - 25)^2$
pCO ₂	$(pCO_2)_{\text{corrected to 25 °C}} = (pCO_2)_{\text{measured}} \times [1 + A (t - 25) + B(t - 25)^2]$
pO ₂	$(pO_2)_{\text{corrected to 25 °C}} = (pO_2)_{\text{measured}} \times [1 + A (t - 25) + B(t - 25)^2]$

Calibrations - automatic and manual

A calibration makes sure that measurement results are accurate and reliable.

The analyzer calibrates most parameters automatically. Only, the sensitivity calibration of the oximetry parameters must be done manually. On the analyzer, this calibration is known as a **tHb calibration**.

If necessary, an extra calibration can be requested. The calibration materials in the Solution Pack are used for this calibration as well as for the calibrations done automatically.

Identification of calibrations in screens

Calibration type	Location	Calibration identifiers	
Automatic calibrations	The Analyzer status screen	Calibration	
	The Calibration log screen	BG	pO_2
		BG, Met	pCO_2 , cGlu, cLac
		Elec, pH	pH, cK ⁺ , cNa ⁺ , cCa ²⁺ , cCl ⁻
	Oxi	Oximetry parameters	
Manual calibration of the oximetry parameters	The Analyzer status screen	tHb Cal	
	The Calibration log screen	tHb calibration	Sensitivity calibration of the oximetry parameters

Manual calibration of the oximetry parameters

On the analyzer a manual calibration of the oximetry parameters is known as a tHb calibration. The calibration adjusts the optical system of the analyzer to make sure that the results of the oximetry parameters are accurate and reliable.

Frequency of automatic calibrations

Automatic calibrations are scheduled by default to be done at regular intervals. Automatic calibrations are also done in connection with replacements, troubleshooting and startup.

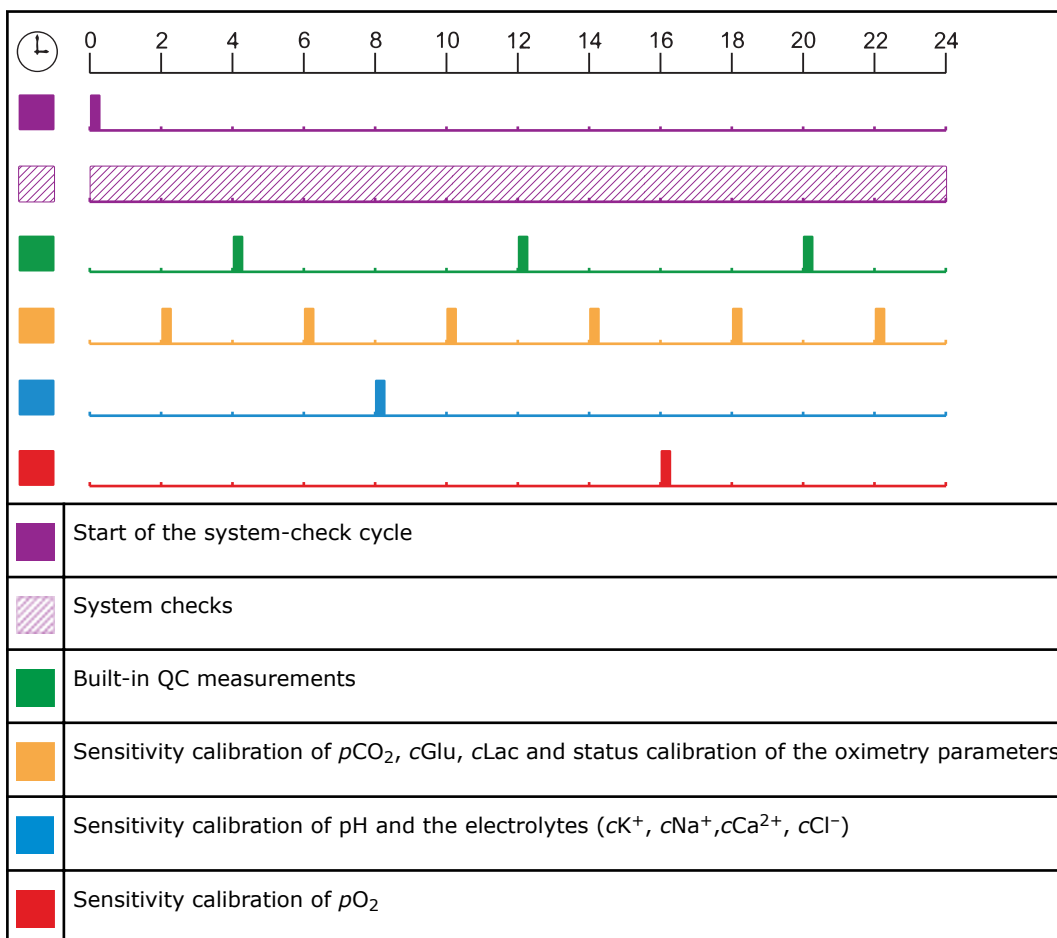

Related information

Calibration frequency after a Sensor Cassette replacement, page 40

To find the status of calibrations

1. Tap **Menu > Analyzer status**.
2. Tap the **Calibrations** button.

Note: A symbol in the **Calibration Type** column shows the status of a calibration.

Symbols that show the calibration status

Symbol	Indication
	The calibration was completed successfully
	An error was found on one or more calibration result
	A scheduled calibration is pending. The last calibration was completed successfully.
	A scheduled calibration is pending. The last calibration was not completed successfully.

Automatic calibrations

To request an unscheduled calibration from the Analyzer status screen

1. Tap **Menu > Analyzer status**.
2. Tap the **Calibrations** button.
3. Select **Calibration** as the **Calibration Type**.
4. Tap the **Calibration** button.

To request an unscheduled calibration from the menu

Prerequisite: Make sure that the analyzer is **Ready**.

1. Tap **Menu > Start programs > Calibration programs > Calibration**.

Manual tHb calibrations

To do a tHb calibration

Prerequisites:



A S7770 ctHb calibration ampoule An Ampoule Opener A QUALICHECK Adapter

- The box that contains the S7770 ctHb calibration ampoule has been stored at a constant temperature (18-32 °C) for 5 hours
- No Inlet Clip is installed on the Inlet Gasket Holder
- Make sure that the analyzer is **Ready**
- Make sure that there are no calibration errors on the tHb parameter

⚠ WARNING – Risk of infection

Make sure you do not prick or scratch yourself on the Inlet Probe.

1. Remove an ampoule from its box.
2. Put the lid back on the box.
The ampoules are sensitive to light.
3. Hold the ampoule between your thumb and first finger and shake it vigorously for a minimum of 15 seconds.
4. Hold the ampoule neck-side up between your fingers and tap the top until all solution collects in the lower part of the ampoule.

- Put the ampoule in the Ampoule Opener.

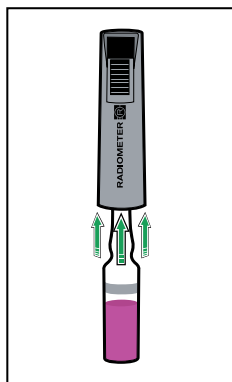

- Use your fingers to apply pressure in the directions shown to break off the neck of the ampoule.

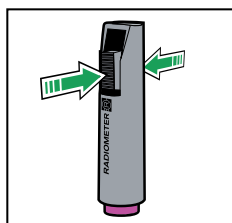

- Remove the ampoule from the Ampoule Opener.
- Put the QUALICHECK Adapter over the open end of the ampoule.

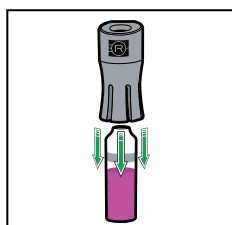

- Tap **Menu > Start programs > Calibration programs > tHb calibration.**
- Scan the barcode on the insert for the S7770 ctHb Calibration Solution.
- Lift the inlet handle of the analyzer to the syringe position.

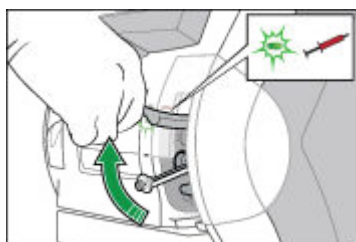

- Turn the QUALICHECK Adapter with the ampoule so the Radiometer logo faces upwards.
- Put the QUALICHECK Adapter with the ampoule over the Inlet Gasket.

14. Push the adapter with the ampoule into the analyzer as far as it will go and hold it there.

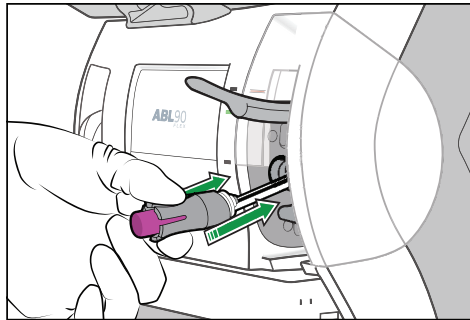

15. Hold the adapter with the ampoule in the pushed-in position until the analyzer tells you to remove it.

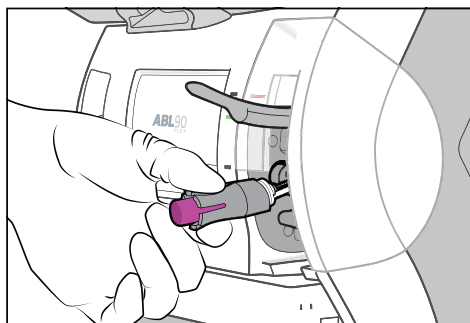

16. When the analyzer tells you to, remove the adapter with the ampoule.
17. Close the inlet.

Note: Sensitivity results between 80 % and 120 % without errors are acceptable.

Calibration results

To find a calibration result

1. Tap **Menu > Data logs > Calibration log**.
2. Select the calibration.

Note: **BG** = pO_2 calibrations; **BG, Met** = pCO_2 , cGlu, cLac calibrations; **Elec, pH** = pH, cK^+ , cNa^+ , cCa^{2+} , cCl^- calibrations and **Oxi** = oximetry parameter calibrations.

3. Tap the **Result** button.

Identification of calibrations in the Calibration log screen

Calibration identifiers	Parameters
BG	pO_2
BG, Met	pCO_2 , cGlu, cLac
Elec, pH	pH, cK^+ , cNa^+ , cCa^{2+} , cCl^-
Oxi	Oximetry parameters

Understanding calibration results

Font style	Description
Black	A result from the current calibration
Dark grey	A result from a previous calibration. The result is still valid.
Red and Red	An error occurred. A message attached to the result describes the error.

Symbol	Description
?	An error occurred or the result is outside a recommended range: <ul style="list-style-type: none"> • Drift value is outside the drift tolerance range • Status value is outside the default range • Sensitivity value is outside the default range
.....	The analyzer could not calculate the value

To see messages on a calibration result

1. Tap **Menu** > **Data logs** > **Calibration log**.
2. Select the calibration.
3. Tap the **Result** button.
4. Tap the **Messages** button.

To troubleshoot messages on results

Prerequisite: You can see the message you want to troubleshoot.

1. Select the message.
2. Tap the **Troubleshoot** button.
3. Follow the instructions on the screen.

Reviewing calibration results

To filter data from the Calibration log

1. Tap **Menu** > **Data logs** > **Calibration log**.
2. Tap the **Filter** button.
3. In the **Criteria** frame, choose an option and follow the steps for it:

Option	Steps
To select a time period prior to today	Tap the number button for the number of days you want
To select a start and end date	Enter data in the Start date: and End date: fields

4. Select the next criterion. If necessary, enter or select a value for it.
5. Do step 4 again for each criterion.
6. Tap the **Apply** button.



To see trends in calibration results

Prerequisite: You have filtered the calibration results from the **Calibration log**.

1. Tap the **Trend** button.
2. Select the parameter.
3. Tap the **View trend** button.

Status in the Calibration log screen

The symbols in the **Status** column of the **Calibration log** screen shows the overall status of each calibration.

Symbol	Description
	The calibration was successful
	An error was found on one or more parameters

Troubleshooting - when is it necessary?

Troubleshooting is necessary when the analyzer goes into a **Operator Action Needed**, **Troubleshooting needed** or **Intervention Required** mode. It may also be necessary to troubleshoot messages in the **Analyzer status** screen.

About guided troubleshooting

In the troubleshooting modes, **Troubleshooting needed** and **Operator Action Needed** modes, text and video instructions guide you through each troubleshooting procedure and show you what to do to get out of the troubleshooting mode.

After each troubleshooting procedure, the analyzer makes checks to find out if the issue has been resolved. If not, a new troubleshooting procedure is shown on the screen. If the guided troubleshooting procedures do not resolve the issue, the analyzer will go into the **Intervention Required**.

To get out of Operator Action Needed mode

1. Follow the text and video instructions on the screen.

To get out of Troubleshooting needed mode

1. Follow the text and video instructions on the screen.

To get out of Intervention Required mode

1. Do the first action shown in the **Suggested actions** frame.
2. Tap the **Test again** button.
3. If the analyzer does not go out of **Intervention Required** mode, do the next action.
4. Tap the **Test again** button.
5. If the analyzer does not go out of **Intervention Required** mode, do steps 3 and 4 again.
6. If none of the actions cause the analyzer to go out of **Intervention Required** mode, contact your local Radiometer representative.

Troubleshooting modes - causes







Troubleshooting mode	Possible causes
Operator Action Needed	<ul style="list-style-type: none">• The inlet was opened when the analyzer was not in Ready mode• The inlet was not closed after a measurement• A consumable must be replaced

Troubleshooting mode	Possible causes
Troubleshooting needed	<ul style="list-style-type: none"> Fluid transport errors were found
Intervention Required	<ul style="list-style-type: none"> If the troubleshooting procedures in the Troubleshooting needed mode did not resolve the issue All other possible errors

To find and troubleshoot messages in the Analyzer status screen

Prerequisite: The traffic light in the **Analyzer status** button is yellow or red.

1. Tap **Menu > Analyzer status**.
2. Tap the button adjacent to a yellow or red traffic light.
3. Choose an option and follow the steps for it.

Option	Steps
To troubleshoot a Recommended action	Follow the instructions on the screen
To troubleshoot Quality control messages	<p>To troubleshoot errors in the Built-in QC and Ampoule-based QC fields:</p> <p>a) Select the quality control measurement marked by a ,</p> <p> or  symbol.</p> <p>b) Tap the Result button.</p> <p>c) Tap the Messages button.</p> <p>d) Select the message.</p> <p>e) Tap the Troubleshoot button.</p> <p>f) Follow the instructions on the screen.</p> <p>To troubleshoot messages in the QC Messages field:</p> <p>a) Select the message.</p> <p>b) Tap the Troubleshoot button.</p> <p>c) Follow the instructions on the screen.</p>
To troubleshoot Calibrations messages	<p>To troubleshoot calibrations marked by a ,  or  symbol.</p> <p>a) Select the marked calibration.</p> <p>b) Tap the Result button.</p> <p>c) Tap the Messages button.</p> <p>d) Select the message.</p> <p>e) Tap the Troubleshoot button.</p> <p>f) Follow the instructions on the screen.</p> <p>To troubleshoot messages in the Message field:</p> <p>a) Select the message.</p> <p>b) Tap the Troubleshoot button.</p> <p>c) Follow the instructions on the screen.</p>
To troubleshoot Consumables or System messages	<p>a) Select the message.</p> <p>b) Tap the Troubleshoot button.</p> <p>c) Follow the instructions on the screen.</p>

Related information

About guided troubleshooting, page 93

To flush the fluid transport system

Prerequisites:

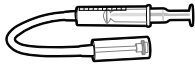

An ABL90 FLEX Flush Device



A paper tissue or a cloth

⚠ WARNING – Risk of infection

Make sure that you wear gloves during replacement and maintenance procedures.

Note: The analyzer will automatically start the workflow for the flush of the fluid transport system when necessary.

1. Draw tap water into the Flush Device up to the 2.5 mL mark.
2. Pull the plunger of the Flush Device up to the 5 mL mark to draw air into it.
3. Tap the **Press to start video guidance** button.
4. When the analyzer tells you to, lift the inlet handle to the capillary position.

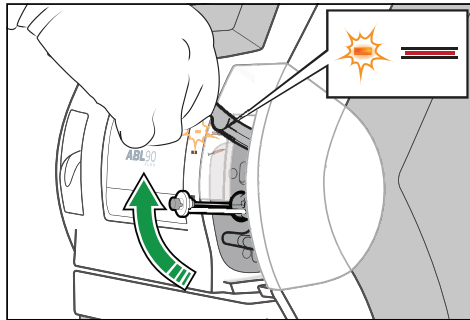

5. Wait until the Solution Pack is ejected.
6. Remove the Solution Pack.

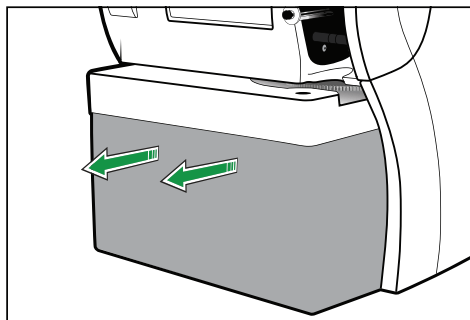

7. Close the inlet handle.
8. Put a tissue or a cloth under the Inlet Gasket Holder.
9. Tap the **Action completed** button.

10. Connect the tip of the Flush Device to the waste connector in the Solution Pack compartment.

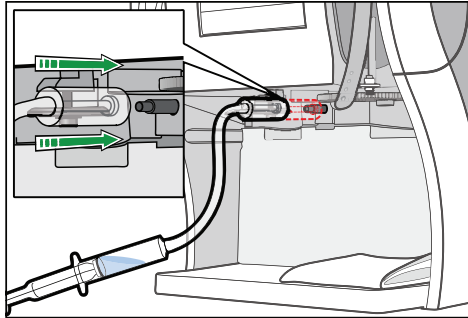

11. Tap the **Action completed** button.
12. Hold the Flush Device as shown.

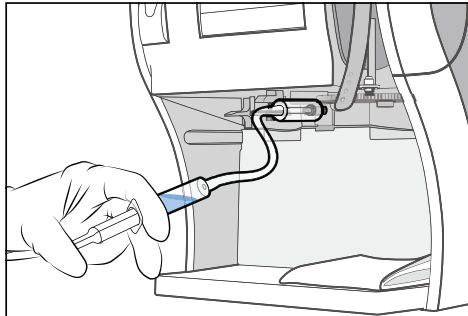

13. Inject a very small quantity of air to fill approximately 1 cm of the tube.
14. Hold the Flush Device as shown.

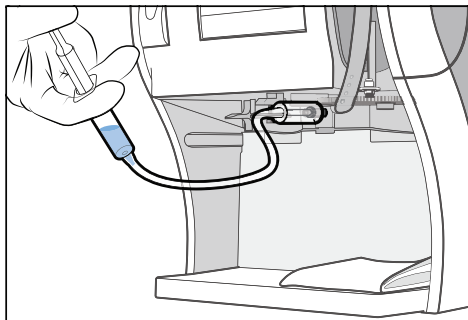

15. Inject a very small quantity of water to fill approximately 1 cm of the tube.
16. Do steps 12 to 15 again several times until the tube is full of water and air bubbles.
17. Tap the **Action completed** button.

18. Hold the Flush Device as shown and push the Inlet Gasket Holder up as far as it will go (approximately 1 cm) and hold it there.

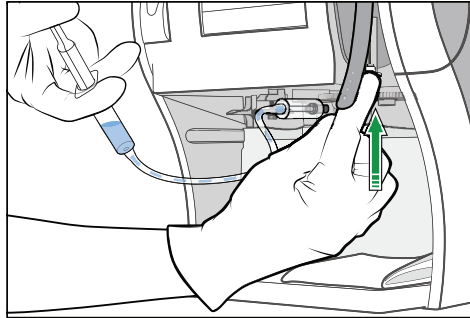

19. Inject water until an unbroken stream of water comes out of the Inlet Probe.

Note: The fluid path is flushed, when this is possible.

Note: If it is not possible, do steps 12 to 15 and step 19 again.

20. Tap the **Action completed** button.
 21. Disconnect the Flush Device.
 22. Remove the tissue or a cloth.
 23. Tap the **Action completed** button.
 24. Lift the inlet handle to the capillary position.

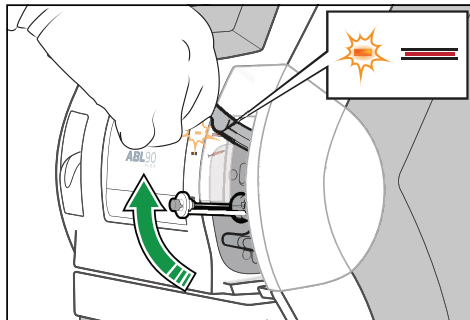

25. Put your thumbs on the white part of the Solution Pack and push the Solution Pack into its compartment until it clicks in place.

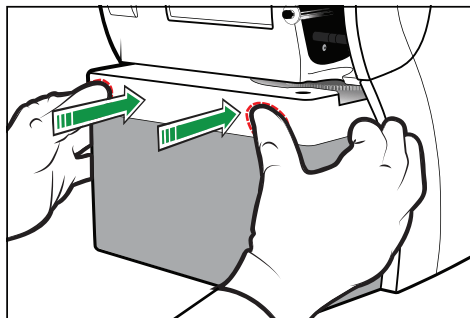

26. When the analyzer tells you to, close the inlet.

Operator actions requested in analyzer messages

To request a tubing refill

1. Tap **Menu** > **Start programs** > **Auxiliary programs** > **Tubing refill**.

To request a liquid sensor adjustment

Note: This procedure measures and adjusts the settings of the liquid sensors.

1. Tap **Menu** > **Start programs** > **Auxiliary programs** > **Liquid sensor adjust**.

To request a pump calibration

Note: This procedure makes sure that the pumps in the analyzer operate correctly.

1. Tap **Menu** > **Start programs** > **Auxiliary programs** > **Pump calibration**.

To request a rinse

Note: This procedure starts a rinse process. A rinse is also done after all measurement activities.

1. Tap **Menu** > **Start programs** > **Auxiliary programs** > **Rinse**.

Troubleshooting Analyzer messages

To troubleshoot Analyzer messages

This procedure can be used to find out what operator actions are necessary to troubleshoot messages.

1. Note the message number (on the left of the message).
2. Find the message and operator actions in the *Analyzer messages* table.

Note: The messages in the table are sorted by number.

Note: If more operator actions are available, start with the first action listed and see if this resolves the issue. If not, continue with the next action listed.

Analyzer messages

No.	Message	Interpretation	Action
1	Inconsistent software versions. Please contact service	Inconsistent software versions for different modules. May appear after replacing a complete module or as a result of an incomplete software upgrade.	- Contact Radiometer service representative.
83	Value above reference range	The parameter value is above the user-defined reference range. This is only a message, not an error.	No action required.

No.	Message	Interpretation	Action
84	Value below reference range	The parameter value is below the user-defined reference range. This is only a message, not an error.	No action required.
85	Value below critical limit	The parameter value is below the user-defined critical limit. This is only a message, not an error	No action required.
86	Value above critical limit	The parameter value is above the user-defined critical limit. This is only a message, not an error.	No action required.
89	Measured QC value above control range	The measured parameter value is above the control range.	<ul style="list-style-type: none"> - Verify the procedure and repeat the measurement. - See the "Instructions for use".
90	Measured QC value below control range	The measured parameter value is below the control range.	<ul style="list-style-type: none"> - Verify the procedure and repeat the measurement. - See the "Instructions for use".
93	Value above reportable range	The parameter value is above the reportable range.	<ul style="list-style-type: none"> - Check for and remedy other errors related to the result, system messages or calibration status. - Perform QC. If the QC result is accepted, the blood sample may be suspected. - Perform measurement on new blood sample.
94	Value below reportable range	The parameter value is below the reportable range.	<ul style="list-style-type: none"> - Check for and remedy other errors related to the result, system messages or calibration status. - Perform QC. If the QC result is accepted, the blood sample may be suspected. - Perform a measurement on new blood sample.
117	LIS/HIS: Invalid connection configuration	The communication configuration or the protocol definition was invalid.	Check the communication parameters specified in Communications Setup.
128	LIS/HIS: Failed to open connection	The communication hardware was busy or the remote system did not respond.	<ul style="list-style-type: none"> - Check that the remote system is running, correctly configured and responding. - Check communication parameters, e.g. baud rate, parity, IP address, etc., as defined in Communication Setup. - Reboot the analyzer.
129	LIS/HIS: Failed to close connection	Messages were queued when the communication channel was closed. Results and other messages sent by the analyzer to a remote system may be lost.	If the problem persists, check the communication hardware. The remote system may lack buffer capacity.

No.	Message	Interpretation	Action
131	LIS/HIS: Failed to send packet	A communication error occurred while sending a message. The message was not sent.	<ul style="list-style-type: none"> - Check that the remote system is running and responding. - Check the communication hardware, including cables. - Repeat sending.
132	LIS/HIS: Failed to receive packet	An error occurred while receiving a message. The analyzer was not able to recognize the received message.	<ul style="list-style-type: none"> - Check that protocol types are correctly configured on both the analyzer and the remote system. - Contact Radiometer service representative.
133	LIS/HIS: Connection lost	A previously established LIS/HIS connection has been lost.	<ul style="list-style-type: none"> - Check that the remote system is running and responding. - Check cables.
134	LIS/HIS: Connection established	The connection was successfully established.	No action required. For information only.
165	LIS/HIS: High-level protocol could not generate high-level packet	An error occurred while formatting a message.	Check protocol configurations. Contact Radiometer service representative.
166	LIS/HIS: General communication error	An internal error occurred in the LIS/HIS communication module.	Contact Radiometer service representative if the problem persists.
167	LIS/HIS: High-level protocol received packet in wrong format	An error occurred while parsing (interpreting) a message.	Check protocol configurations. Contact Radiometer service representative.
200	Operator msg:	This is only a message. An operator has entered a note in the log.	No action required.
201	Westgard Rule (1.2s) violation	Measured parameter value is outside the mean +/- 2 SD range.	<ul style="list-style-type: none"> - Verify procedure and repeat measurement. - Check Replacement Status for pending replacements. - See the "Instructions for use" for detailed evaluation procedure.
202	Westgard Rule (1.3s) violation	Measured parameter value is outside the mean +/- 3 SD range.	<ul style="list-style-type: none"> - Verify procedure and repeat measurement. - Check Replacement Status for pending replacements including electrodes. - See the "Instructions for use" for detailed evaluation procedure.
203	Westgard Rule (2.2s) violation	Two consecutive measurements are outside the mean +/- 2 SD range on the same side of the mean. This may indicate a shift.	<ul style="list-style-type: none"> - Verify procedure and repeat measurement. - Check Replacement Status for pending replacements including electrodes. - See the "Instructions for use" for detailed evaluation procedure.

No.	Message	Interpretation	Action
204	Westgard Rule (R. 4s) violation	The difference between two consecutive measurements exceeds 4 SD. This may indicate an inconsistency in your procedure or an unstable analyzer.	<ul style="list-style-type: none"> - Verify procedure and repeat measurement. - Check Replacement Status for pending electrode replacements. - See the "Instructions for use" for detailed evaluation procedure.
205	Westgard Rule (4.1s) violation	Four consecutive measurements are outside the mean +/- 1 SD range on the same side of the mean. A trend or shift is indicated. Patient results should be considered unreliable until the problem is remedied.	<ul style="list-style-type: none"> - Check for excessive electrode sensor calibration drift. - Check Replacement Status for pending electrode replacements. - See the "Instructions for use" for evaluation procedure.
206	Westgard Rule (10.x) violation	Ten consecutive measurements are on the same side of the mean. A trend or shift is indicated. Patient results should be considered unreliable until the problem is remedied.	<ul style="list-style-type: none"> - Check the electrode drift during last calibration. - Check Replacement Status for pending electrode replacements. - See the "Instructions for use" for evaluation procedure.
207	Calibration schedule reminder(s) present	One or more scheduled calibrations are overdue.	Check the Calibration Status and perform any pending calibrations.
208	Quality control schedule reminder(s) present	One or more scheduled QC measurements are overdue.	Check the Quality Control Status and perform the pending quality control.
209	Replacement schedule reminder(s) present	One or more scheduled replacements are overdue.	Check the Replacement Status and perform any pending replacement actions.
210	Calibration error(s) present	An error registered on one or more parameters during the last calibration.	Check Calibration Status for errors in latest calibration results for the given parameter. View calibration error messages and take required corrective action.
211	Quality control error(s) present	One or more errors were registered during last QC measurement on one of the installed QC levels.	Check Quality Control Status for errors. View QC error messages and take required corrective action.
212	System message(s) present	One or more systems errors are present.	Check the System Messages Status for errors. Take corrective required action.
213	Automatic backup failed	An error occurred during the scheduled data backup.	<ul style="list-style-type: none"> - Check Automatic Backup Setup. - Check network and servers used for the backup. - Contact your IT engineer.
214	Automatic backup succeeded	The scheduled automatic backup was completed successfully.	No action required.

No.	Message	Interpretation	Action
216	General printer error	A printer problem has occurred, e.g. the paper is jammed	<ul style="list-style-type: none"> - Check printer paper. Clear any jam. - Power down and restart the analyzer. - Contact Radiometer service representative.
217	Replacement:	The message is used in the Activity Log to indicate a performed replacement.	No action required.
290	Warning: SHb detected	FSHb detected in the range of 1-10 %.	No action required. For information only.
291	SHb too high	Detected FSHb is greater than 10%. Measurement accuracy is affected.	<ul style="list-style-type: none"> - Repeat the measurement.
292	Turbidity too high	Turbidity is greater than 5 %: too high for reliable measurements.	<ul style="list-style-type: none"> - Hyperlipemic sample; decrease the lipemic content by e.g. centrifuge or extraction. - Perform the measurement on a blood sample from a healthy donor. - Contact Radiometer service representative.
293	Oxi compensated for HbF	OXI parameters have been HbF compensated. Parameter FHbF may be shown or not shown.	No action required. For information only.
329	QC expiration date exceeded	The quality control measurement was performed on an expired control solution.	<ul style="list-style-type: none"> - Discontinue the use of the lot and set up a valid lot for the control solution.
331	No sample detected during sample aspiration	No sample detected in sensor. Measurement is aborted.	<ul style="list-style-type: none"> - Ensure that adequate sample volume is used. - Check the sample for clots.
357	Temp. error: Barometer	Temperature in the barometer on the Analyzer Control is outside 37 +/- 1.0 °C.	<ul style="list-style-type: none"> - Ensure that the ambient temperature is between 15 and 32 °C. - If the system has just performed a cold start, wait for the error to disappear. - Shield the analyzer from direct sunlight and other heat sources. - Contact Radiometer service representative.
375	Calibration status out of limits	The status value is outside the range for the given parameter.	<ul style="list-style-type: none"> - Check for and remedy any system messages. - Repeat the calibration. - Check solution pack status and replace, if necessary. - Check sensor cassette status and replace, if necessary.

No.	Message	Interpretation	Action
376	Calibration Drift 1 out of range	The Drift 1 value exceeds the tolerance.	<ul style="list-style-type: none"> - Check for and remedy any system messages. - Repeat the calibration. - Check solution pack status and replace, if necessary. - Check sensor cassette status and replace, if necessary.
377	Calibration Drift 2 out of range	The Drift 2 value exceeds the tolerance.	<ul style="list-style-type: none"> - Check for and remedy any system messages. - Repeat the calibration. - Check solution pack status and replace, if necessary. - Check sensor cassette status and replace, if necessary.
378	Calibration sensitivity out of range	The sensitivity value is out of range for the given parameter.	<ul style="list-style-type: none"> - Check for and remedy any system messages. - Repeat the calibration. - Check solution pack status and replace, if necessary. - Check sensor cassette status and replace, if necessary.
379	Calibration unstable (response fault)	An electrode response fault occurred during calibration.	<ul style="list-style-type: none"> - Check for and remedy any system messages. - Repeat the calibration. - Check solution pack status and replace, if necessary. - Check sensor cassette status and replace, if necessary.
443	Ca(7.4) not usable	cCa ²⁺ at a pH of 7.4 is not usable as the actual pH is outside the 7.2-7.6 range.	No action required.
452	Interference during measurement	Interference was detected during measurement.	Check the patient record for medication containing possible interfering substances.
484	Today is last day in stat. month - remember to print QC statistics	After the current day, quality control statistics obtained over the month will be deleted and new statistics started.	Print the QC statistics if a copy is required.
487	A new statistical month has begun - remember to export WDC data	A new statistical month has begun.	Make a WDC report disk.
494	Bilirubin too high	Detected bilirubin concentration, ctBil(blood), is greater than 2000 µmol/L. The corresponding plasma bilirubin concentration can be calculated as follows: ctBil(blood) = (1-Hct) × ctBil(plasma).	No action required.

No.	Message	Interpretation	Action
508	Liquid transport error during rinse	Liquid transport of Rinse failed	- Check solution pack or sensor cassette status and replace, if necessary.
512	Temperature error	The temperature was outside the required range during measurement or calibration. All results are marked with "?".	<ul style="list-style-type: none"> - Ensure that the ambient temperature is between 15 and 32 °C. - If the analyzer has recently performed a cold start, wait for the temperature error to disappear. - If the solution pack or sensor cassette has recently been replaced, wait for the temperature error to disappear. - Shield analyzer from direct sunlight or heat sources. - Contact Radiometer service representative.
521	Inhomogeneous sample	Air bubbles were detected in the sample. Results may have "?".	- Repeat the measurement.
522	Calibration error	One or more calibration values are erroneous.	<ul style="list-style-type: none"> - Check for and remedy any system messages. - Repeat the calibration. - Check solution pack status and replace, if necessary. - Check sensor cassette status and replace, if necessary.
523	Calibration drift out of range	Calibration drift exceeds defined limits.	<ul style="list-style-type: none"> - Check for and remedy any System Messages. - Perform any pending replacements including electrodes. - Check that electrodes are properly installed. - Verify that proper solutions and gases are used. - Perform the Electrode Troubleshooting procedure.
529	Inlet LS failed to calibrate	Inlet liquid sensor failed to calibrate.	<ul style="list-style-type: none"> - Repeat the liquid sensor calibration. - Contact Radiometer service representative.
531	Sensors LS failed to calibrate	Liquid sensor near the sensor cassette failed to calibrate.	<ul style="list-style-type: none"> - Repeat the liquid sensor calibration. - Check solution pack status and replace if necessary. - Contact Radiometer service representative.
537	OXI LS failed to calibrate	OXI module liquid sensor failed to calibrate.	<ul style="list-style-type: none"> - Repeat the liquid sensor calibration. - Check solution pack status and replace, if necessary. - Contact Radiometer service representative.

No.	Message	Interpretation	Action
581	OXI spectrum mismatch	Spectrum deviates from the expected blood or QC spectrum. Measurement may be unreliable.	<ul style="list-style-type: none"> - Check the patient record for medication containing possible interfering substances. - Start a calibration. - Contact Radiometer service representative.
582	tHb calibration cuvette factor outside limits	tHb calibration failed.	<ul style="list-style-type: none"> - Perform a calibration. - Repeat the tHb calibration. - Contact Radiometer service representative.
584	tHb calibration wavelength outside limits	tHb calibration failed.	<ul style="list-style-type: none"> - Perform a calibration. - Repeat the tHb calibration. - Contact Radiometer service representative.
588	Measured QC value lower than statistical range	The parameter value is below the lower limit of the operator-defined statistical range. Measurement is not included in statistics.	<ul style="list-style-type: none"> - Verify the procedure and repeat the measurement. - See the "Instructions for use" for details on the evaluation of the results.
589	Measured QC value higher than statistical range	The parameter value is above the upper limit of the operator-defined statistical range. Measurement not included into statistics.	<ul style="list-style-type: none"> - Verify the procedure and repeat the measurement. - See the "Instructions for use" for details on the evaluation of the results.
593	Insufficient sample	Sample volume is too small for the selected measuring mode. Affected parameters will be marked with "?".	<ul style="list-style-type: none"> - Repeat the measurement, ensuring sufficient sample volume. - Contact Radiometer service representative.
595	Liquid sensor calibration error	One or more of the liquid sensors failed calibration.	<ul style="list-style-type: none"> - Repeat the liquid sensor calibration. - Check solution pack status and replace, if necessary. - Contact Radiometer service representative.
606	Cal expired (pH)	Too long time passed since the last successful calibration of the parameter. Parameter measurement values are reported as ".....".	Perform a calibration.
608	Cal expired (pCO ₂)	Too long time passed since the last successful calibration of the parameter. Parameter measurement values are reported as ".....".	Perform a calibration.
609	Cal expired (pO ₂)	Too long time passed since the last successful calibration of the parameter. Parameter measurement values are reported as ".....".	Perform a calibration.
610	Cal expired (K)	Too long time passed since the last successful calibration of the parameter. Parameter measurement values are reported as ".....".	Perform a calibration.

No.	Message	Interpretation	Action
611	Cal expired (Na)	Too long time passed since the last successful calibration of the parameter. Parameter measurement values are reported as ".....".	Perform a calibration.
612	Cal expired (Ca)	Too long time passed since the last successful calibration of the parameter. Parameter measurement values are reported as ".....".	Perform a calibration.
613	Cal expired (Cl)	Too long time passed since the last successful calibration of the parameter. Parameter measurement values are reported as ".....".	Perform a calibration.
614	Cal expired (Glu)	Too long time passed since the last successful calibration of the parameter. Parameter measurement values are reported as ".....".	Perform a calibration.
615	Cal expired (Lac)	Too long time passed since the last successful calibration of the parameter. Parameter measurement values are reported as ".....".	Perform a calibration.
616	Cal expired (OXI)	Too long time elapsed since the last successful calibration of the parameter. Parameter measurement values are reported as ".....".	Perform a calibration.
641	ABL/DMS PC restarted	The analyzer was restarted from power off.	No action required. For information only.
642	ABL/DMS PC connected to wet section	Added by DMS PC when connection to the wet section is obtained.	- No action required.
643	ABL/DMS PC disconnected from wet section	The connection from the DMS PC to the wet section is lost.	- Shut down and restart the analyzer. - Contact Radiometer service representative.
648	Calibration failed or not accepted	The last calibration was aborted or not accepted.	- Check solution pack status and replace, if necessary. - Check sensor cassette status and replace, if necessary. - Check for and remedy system messages. - Repeat the calibration.
662	Barometer out of range	Measured barometer value is outside the measuring range: 60-106.7 kPa.	- Contact Radiometer service representative.
669	QC value outside control range	Measured parameter value is outside control range.	- Verify the procedure and repeat measurement. - Refer to Quality Control Systems Reference Manual.
679	Barometer error	The measured parameter may be unreliable due to barometer error.	Contact Radiometer service representative.

No.	Message	Interpretation	Action
682	OXI module not active	The OXI module is not responding due to an internal communication problem, or the software configuration does not match the analyzer type.	<ul style="list-style-type: none"> - Shut down the analyzer, using the Temporary Shutdown function; then restart it. - Contact Radiometer service representative.
688	ctHb/ceHb too low for OXI calculation	ctHb < 1 mmol/L, or ceHb < 0.75 mmol/L. If ctHb is too low, FHHb, FO2Hb, FCOHb and FMetHb are not calculated. If ceHb = cHHb + cO2Hb is too low, sO2 is not calculated.	If Oxi derivatives are wanted, elevate tHb and/or sO2.
692	ABL not connected to RADIANCE	The analyzer is not connected to RADIANCE.	<ul style="list-style-type: none"> - Contact your RADIANCE/IT engineer. - Check RADIANCE Communication Setup including TCP/IP address, port no. and password. - Check that RADIANCE is responding. - Check network connections.
693	ABL not connected to RADIANCE - incorrect password	The analyzer was refused connection to RADIANCE due to incorrect password.	Enter the correct password in the analyzer's RADIANCE Communication Setup.
694	ABL connected to RADIANCE	The analyzer is connected to RADIANCE.	No action required.
695	ABL disconnected from RADIANCE	The analyzer was disconnected from RADIANCE.	No action required.
696	ABL<>RADIANCE communication error	Communication error between the analyzer and RADIANCE.	Contact Radiometer service representative.
699	Built-in QC measurement started due to calibration error	The analyzer was set up to perform built-in QC measurements in case of calibration errors.	Check Calibration Status and remedy any reported calibration errors.
700	Scheduled built-in QC not run due to errors in last calibration	Last calibration contained an error, and the analyzer was set up to suspend built-in QC measurements in case of calibration errors.	Check Calibration Status and remedy calibration errors.
703	QC expired	QC measurement is overdue (corrective action "Lock analyzer" has been selected in the Setup program: Corrective Actions).	Perform a quality control measurement.
704	Built-in QC measurement is repeated	The scheduled QC measurement was not accepted; the measurement was repeated as requested in the Setup program: Corrective Actions.	No action required.
705	Built-in QC measurement is repeated twice	The scheduled QC measurement was not accepted; the measurement was repeated twice as requested in the Setup program: Corrective Actions.	No action required.

No.	Message	Interpretation	Action
707	Replacement(s) overdue by 10 %. Analyzer locked.	Replacement is overdue by 10 % (corrective action "Lock analyzer" was selected in the Setup program: Corrective Actions). When the analyzer is locked, scheduled calibrations are performed, but no patient samples or QC measurements are allowed.	<ul style="list-style-type: none"> - Check Replacement Status and replace as required. - Unlock analyzer in the Miscellaneous Setup program.
708	Corrective action not possible due to empty solution pack	Scheduled built-in QC measurement was requested, but the solution pack was empty.	Insert a new solution pack.
712	FHbF measurement not possible	Composition of the blood sample makes FHbF measurement too inaccurate, but OXI parameters are compensated for HbF. See explanation in the "Instructions for use".	If FHbF is wanted change sample composition. For example, elevate sO ₂ and tHb.
713	ctBil measurement not possible	Blood sample ctHb is so high that hardly any plasma is left to measure plasma bilirubin on. ctHb > 14.56mmol/L.	If ctBil is wanted, lower the ctHb value.
734	General WSM exception	The data management system establishes connection to the analyzing unit, or the connection is lost.	<ul style="list-style-type: none"> - Wait a few minutes for the connection to establish. - Restart the analyzer. - If the error persists, contact Radiometer service representative.
745	Low disk space	Free disk space is low.	Move archive files to another storage device.
766	ABL not connected to RADIANCE - no RADIANCE connection license	The analyzer has been refused connection to RADIANCE because there is no connection license available on RADIANCE.	Contact RADIANCE/IT engineer or Radiometer service representative.
767	ABL not connected to RADIANCE - ABL StatLink version too high	The analyzer has been refused connection to RADIANCE because the ABL StatLink version is higher than the RADIANCE StatLink version.	Contact RADIANCE/IT engineer or Radiometer service representative.
768	ABL not connected to RADIANCE - ABL StatLink version too low	The analyzer has been refused connection to RADIANCE because the ABL StatLink version is lower than the RADIANCE StatLink version.	Contact RADIANCE/IT engineer or Radiometer service representative.
769	ABL<>RADIANCE communication error - XML packet could not be parsed	Communication error between the analyzer and RADIANCE.	Contact RADIANCE/IT engineer or Radiometer service representative.
770	Failed to restore Custom Setup	The setup could not be restored.	<ul style="list-style-type: none"> - Download the setup data from another floppy disk, hard disk or network drive. - Contact Radiometer service representative if the error persists.
771	Succeeded to restore Custom Setup	Restoring of setup is completed.	No action required.
772	Operator Activity:	Operator activity logged by operator.	No action required.

No.	Message	Interpretation	Action
773	Remote operator logged on with operator:	A remote operator has logged on the analyzer via NetOp.	No action required.
774	Remote operator logged off with operator:	An operator, remotely logged on via NetOp, has logged off, or has been logged off by a local operator.	No action required.
775	Failed to restore Default Setup	Restoring analyzer setup to default values has failed.	Contact Radiometer service representative.
776	Succeeded to restore Default Setup	Restoring setup to default values is completed.	No action required.
780	RADIANCE communication enabled	RADIANCE communication has been enabled as part of the RADIANCE Connection Setup.	No action required. For information only.
781	RADIANCE communication disabled	RADIANCE communication has been disabled as part of the RADIANCE Connection Setup.	No action required. For information only.
782	RADIANCE output queue cleared	The output queue was cleared in the RADIANCE Connection Setup.	No action required. For information only.
783	Automatic backup started	Automatic backup (selected in Disk Functions Setup) has started.	No action required. For information only.
785	Automatic archiving started	Automatic archiving (selected in Disk Functions Setup) has started.	No action required. For information only.
786	Automatic archiving completed	Automatic archiving (selected in Disk Functions Setup) completed successfully.	No action required. For information only.
787	Export of data logs started	Export of data logs was started by the operator.	No action required. For information only.
798	Operator logged on	Operator logged on successfully.	No action required. For information only.
799	Operator logged off	Operator logged off.	No action required. For information only.
800	Logon attempt failed	Operator tried to log on but did not provide a valid password.	Provide a valid password to log on.
810	pH locked	The parameter has been locked by a RADIANCE operator, as reflected in the Activity Log. When a parameter is locked, presumably due to problems with QC, the parameter is repressed in patient results.	Await corrective actions initiated by the RADIANCE operator.
811	pCO2 locked	The parameter has been locked by a RADIANCE operator, as reflected in the Activity Log. When a parameter is locked, presumably due to problems with QC, the parameter is repressed in patient results.	Await corrective actions initiated by the RADIANCE operator.

No.	Message	Interpretation	Action
812	pO2 locked	The parameter has been locked by a RADIANCE operator, as reflected in the Activity Log. When a parameter is locked, presumably due to problems with QC, the parameter is repressed in patient results.	Await corrective actions initiated by the RADIANCE operator.
813	K locked	The parameter has been locked by a RADIANCE operator, as reflected in the Activity Log. When a parameter is locked, presumably due to problems with QC, the parameter is repressed in patient results.	Await corrective actions initiated by the RADIANCE operator.
814	Na locked	The parameter has been locked by a RADIANCE operator, as reflected in the Activity Log. When a parameter is locked, presumably due to problems with QC, the parameter is repressed in patient results.	Await corrective actions initiated by the RADIANCE operator.
815	Cl locked	The parameter has been locked by a RADIANCE operator, as reflected in the Activity Log. When a parameter is locked, presumably due to problems with QC, the parameter is repressed in patient results.	Await corrective actions initiated by the RADIANCE operator.
816	Ca locked	The parameter has been locked by a RADIANCE operator, as reflected in the Activity Log. When a parameter is locked, presumably due to problems with QC, the parameter is repressed in patient results.	Await corrective actions initiated by the RADIANCE operator.
818	Glu locked	The parameter has been locked by a RADIANCE operator, as reflected in the Activity Log. When a parameter is locked, presumably due to problems with QC, the parameter is repressed in patient results.	Await corrective actions initiated by the RADIANCE operator.
819	Lac locked	The parameter has been locked by a RADIANCE operator, as reflected in the Activity Log. When a parameter is locked, presumably due to problems with QC, the parameter is repressed in patient results.	Await corrective actions initiated by the RADIANCE operator.
820	tHb locked	The parameter has been locked by a RADIANCE operator, as reflected in the Activity Log. When a parameter is locked, presumably due to problems with QC, the parameter is repressed in patient results.	Await corrective actions initiated by the RADIANCE operator.
821	MetHb locked	The parameter has been locked by a RADIANCE operator, as reflected in the Activity Log. When a parameter is locked, presumably due to problems with QC, the parameter is repressed in patient results.	Await corrective actions initiated by the RADIANCE operator.

No.	Message	Interpretation	Action
822	COHb locked	The parameter has been locked by a RADIANCE operator, as reflected in the Activity Log. When a parameter is locked, presumably due to problems with QC, the parameter is repressed in patient results.	Await corrective actions initiated by the RADIANCE operator.
823	HHb locked	The parameter has been locked by a RADIANCE operator, as reflected in the Activity Log. When a parameter is locked, presumably due to problems with QC, the parameter is repressed in patient results.	Await corrective actions initiated by the RADIANCE operator.
824	O2Hb locked	The parameter has been locked by a RADIANCE operator, as reflected in the Activity Log. When a parameter is locked, presumably due to problems with QC, the parameter is repressed in patient results.	Await corrective actions initiated by the RADIANCE operator.
825	sO2 locked	The parameter has been locked by a RADIANCE operator, as reflected in the Activity Log. When a parameter is locked, presumably due to problems with QC, the parameter is repressed in patient results.	Await corrective actions initiated by the RADIANCE operator.
826	HbF locked	The parameter has been locked by a RADIANCE operator, as reflected in the Activity Log. When a parameter is locked, presumably due to problems with QC, the parameter is repressed in patient results.	Await corrective actions initiated by the RADIANCE operator.
827	tBil locked	The parameter has been locked by a RADIANCE operator, as reflected in the Activity Log. When a parameter is locked, presumably due to problems with QC, the parameter is repressed in patient results.	Await corrective actions initiated by the RADIANCE operator.
831	pH unlocked	The message is used in the Activity Log to indicate that a previously locked parameter has been unlocked.	No action required. For information only.
832	pCO2 unlocked	The message is used in the Activity Log to indicate that a previously locked parameter has been unlocked.	No action required. For information only.
833	pO2 unlocked	The message is used in the Activity Log to indicate that a previously locked parameter has been unlocked.	No action required. For information only.
834	K unlocked	The message is used in the Activity Log to indicate that a previously locked parameter has been unlocked.	No action required. For information only.
835	Na unlocked	The message is used in the Activity Log to indicate that a previously locked parameter has been unlocked.	No action required. For information only.
836	Cl unlocked	The message is used in the Activity Log to indicate that a previously locked parameter has been unlocked.	No action required. For information only.

No.	Message	Interpretation	Action
837	Ca unlocked	The message is used in the Activity Log to indicate that a previously locked parameter has been unlocked.	No action required. For information only.
839	Glu unlocked	The message is used in the Activity Log to indicate that a previously locked parameter has been unlocked.	No action required. For information only.
840	Lac unlocked	The message is used in the Activity Log to indicate that a previously locked parameter has been unlocked.	No action required. For information only.
841	tHb unlocked	The message is used in the Activity Log to indicate that a previously locked parameter has been unlocked.	No action required. For information only.
842	MetHb unlocked	The message is used in the Activity Log to indicate that a previously locked parameter has been unlocked.	No action required. For information only.
843	COHb unlocked	The message is used in the Activity Log to indicate that a previously locked parameter has been unlocked.	No action required. For information only.
844	HHb unlocked	The message is used in the Activity Log to indicate that a previously locked parameter has been unlocked.	No action required. For information only.
845	O2Hb unlocked	The message is used in the Activity Log to indicate that a previously locked parameter has been unlocked.	No action required. For information only.
846	sO2 unlocked	The message is used in the Activity Log to indicate that a previously locked parameter has been unlocked.	No action required. For information only.
847	HbF unlocked	The message is used in the Activity Log to indicate that a previously locked parameter has been unlocked.	No action required. For information only.
848	tBil unlocked	The message is used in the Activity Log to indicate that a previously locked parameter has been unlocked.	No action required. For information only.
852	RADIANCE:	Message from RADIANCE.	No action required. For information only.
855	Base Excess out of range	Base Excess exceeds the +/- 30 mmol/L range.	For information only. No analyzer error was detected.
875	Sample aged	The specified limit for sample age has been exceeded.	Draw and analyze new sample.
885	Cyclic QC schedule reset from RADIANCE	The cyclic QC schedule has been reset and all related reminders have been removed as a result of a RADIANCE command.	No action required. For information only.
886	LIS/HIS: No valid POCT1A DML Device ID file	A file with a valid Device ID does not exist. A valid Device ID is needed in order to use the POCT1A DML protocol.	Contact Radiometer service representative to obtain a Device ID file.
963	Leak current in analyzer detected	Leak currents were detected during system calibration and may distort measuring results.	<ul style="list-style-type: none"> - Replace inlet connector gasket, sensor cassette or solution pack. - Contact Radiometer service representative.

No.	Message	Interpretation	Action
964	Leak current in relation to solution pack detected	Leak currents were detected during system calibration and may distort measuring results.	<ul style="list-style-type: none"> - Replace solution pack. - Contact Radiometer service representative.
970	Replace solution pack	This message is shown when the solution pack needs to be replaced. The analyzer will enter "Operator-intervention required".	<ul style="list-style-type: none"> - Replace solution pack.
971	Replace sensor cassette	This message is shown when the sensor cassette needs to be replaced. The analyzer will enter "Operator-intervention required".	<ul style="list-style-type: none"> - Replace sensor cassette.
973	Printer paper must be replaced	No more paper in printer.	Insert new printer paper.
978	Flow selector calibration error	Shown in the Activity Log when "Operator-intervention required" has been entered due to this reason.	The analyzer will automatically enter "Operator-intervention required". Follow the instructions shown on the screen.
979	Inhomogeneous rinse solution	Shown in the Activity Log when "Operator-intervention required" has been entered due to this reason.	The analyzer will automatically enter "Operator-intervention required". Follow the instructions shown on the screen.
983	Inhomogeneous cal 3 solution	Shown in the Activity Log when "Operator-intervention required" has been entered due to this reason.	The analyzer will automatically enter "Operator-intervention required". Follow the instructions shown on the screen.
984	The analyzer could not aspirate homogeneous calibration solution	Shown in the Activity Log when "Operator-intervention required" has been entered due to this reason.	The analyzer will automatically enter "Operator-intervention required". Follow the instructions shown on the screen.
1000	Number of pO ₂ hardware data fail	Can be shown on a result if unable to calculate oxygen due to an unexpected system error.	<ul style="list-style-type: none"> - Restart the analyzer. - Perform a calibration. - Contact Radiometer service representative.
1001	Timeout while waiting for pO ₂ hardware data	Can be shown on a result if unable to calculate oxygen due to an unexpected system error.	<ul style="list-style-type: none"> - Restart the analyzer. - Perform a calibration. - Contact Radiometer service representative.
1002	pO ₂ dark data is out of range	Can be shown on a result if unable to calculate oxygen due to an unexpected system error.	<ul style="list-style-type: none"> - Restart the analyzer. - Perform a calibration. - Contact Radiometer service representative.
1004	Unable to calculate oxygen parameter	Can be shown on a result if unable to calculate oxygen due to an unexpected system error.	<ul style="list-style-type: none"> - Restart the analyzer. - Perform a calibration. - Contact Radiometer service representative.
1005	Unable to calculate oxygen parameter	Can be shown on a result if unable to calculate oxygen due to an unexpected system error.	<ul style="list-style-type: none"> - Restart the analyzer. - Perform a calibration. - Contact Radiometer service representative.

No.	Message	Interpretation	Action
1006	Unable to calculate oxygen parameter	Can be shown on a result if unable to calculate oxygen due to an unexpected system error.	<ul style="list-style-type: none"> - Restart the analyzer. - Perform a calibration. - Contact Radiometer service representative.
1007	Missing oxygen calibration	No calibration data exists for oxygen.	Perform a calibration.
1008	Unable to calculate oxygen parameter	Can be shown on a result if unable to calculate oxygen due to an unexpected system error.	<ul style="list-style-type: none"> - Restart the analyzer. - Perform a calibration. - Contact Radiometer service representative.
1009	Unable to calculate oxygen parameter	Can be shown on a result if unable to calculate oxygen due to an unexpected system error.	<ul style="list-style-type: none"> - Restart the analyzer. - Perform a calibration. - Contact Radiometer service representative.
1010	Oxi data collection error	Oxi hardware problem	<ul style="list-style-type: none"> - Restart the analyzer. - Perform a calibration. - Contact Radiometer service representative.
1011	Oxi has no Blank Cal	Missing Blank Cal. Not necessarily a hardware error.	<ul style="list-style-type: none"> - Perform a calibration. - Restart the analyzer. - Contact Radiometer service representative.
1012	Oxi has no sample spectrum	The system has not made a sample measurement yet, or there is a hardware problem.	<ul style="list-style-type: none"> - Repeat the measurement. - Restart the analyzer. - Contact Radiometer service representative.
1013	Oxi data collection error	Oxi hardware error	<ul style="list-style-type: none"> - Restart the analyzer. - Perform a calibration. - Contact Radiometer service representative.
1014	Oxi Blank Cal. intensity too high	The spectrometer received too high light intensity during Blank Cal.	<ul style="list-style-type: none"> - Check solution pack. During Oxi Blank calibration, the cuvette must be filled with liquid. - Perform a calibration. - Restart the analyzer. - Contact Radiometer service representative.
1015	Oxi sample intensity too high	The spectrometer received too high light intensity during sample measurement.	<ul style="list-style-type: none"> - Check solution pack. During Oxi Blank calibration, the cuvette must be filled with liquid. - Perform a calibration. - Repeat the sample measurement.

No.	Message	Interpretation	Action
1016	Oxi Blank Cal. intensity too low	The spectrometer received too low light intensity during Blank Cal.	<ul style="list-style-type: none"> - Perform a calibration. - Restart the analyzer. - Contact Radiometer service representative.
1017	Oxi sample intensity too low	The spectrometer received too low light intensity during sample measurement.	<ul style="list-style-type: none"> - Restart the analyzer. - Perform a calibration. - Contact Radiometer service representative.
1018	Oxi electronic adjustment error	Oxi hardware problem.	<ul style="list-style-type: none"> - Restart the analyzer. - Perform a calibration. - Contact Radiometer service representative.
1019	Oxi Blank Cal. outside limits	Peak value of Blank Cal. spectrum intensity is outside acceptance limits.	<ul style="list-style-type: none"> - Check solution pack. The cuvette must be filled with liquid during Blank calibration. - Perform a calibration. - Restart the analyzer. - Contact Radiometer service representative.
1020	Oxi neon intensity outside limits	Oxi hardware problem.	<ul style="list-style-type: none"> - Restart the analyzer. - Perform a calibration. - Contact Radiometer service representative.
1021	Oxi neon correction outside limits	Oxi hardware problem.	<ul style="list-style-type: none"> - Restart the analyzer. - Contact Radiometer service representative.
1022	Oxi background correction outside limits	Oxi hardware problem.	<ul style="list-style-type: none"> - Restart the analyzer. - Contact Radiometer service representative.
1023	Oxi spectrometer memory read problem	Oxi hardware problem.	<ul style="list-style-type: none"> - Restart the analyzer. - Contact Radiometer service representative.
1024	Oxi spectrometer memory write problem	Oxi hardware problem.	<ul style="list-style-type: none"> - Restart the analyzer. - Contact Radiometer service representative.
1025	Oxi hemolyzer tuning problem	Oxi hardware problem.	<ul style="list-style-type: none"> - Restart the analyzer - Contact Radiometer service representative.
1026	Oxi hemolyzer frequency problem	Oxi hardware problem.	<ul style="list-style-type: none"> - Restart the analyzer. - Contact Radiometer service representative.

No.	Message	Interpretation	Action
1027	Oxi hemolyzer temperature deviation too high	Oxi hardware problem.	<ul style="list-style-type: none"> - Restart the analyzer. - Contact Radiometer service representative.
1028	Oxi neon voltage outside limits	Oxi hardware problem.	<ul style="list-style-type: none"> - Restart the analyzer. - Contact Radiometer service representative.
1029	Oxi light source voltage outside limits	Oxi hardware problem.	<ul style="list-style-type: none"> - Restart the analyzer. - Contact Radiometer service representative.
1030	Oxi hemolyzer voltage outside limits	Oxi hardware problem.	<ul style="list-style-type: none"> - Restart the analyzer. - Contact Radiometer service representative.
1031	Oxi initialization in progress	Oxi initialization in progress.	<ul style="list-style-type: none"> - Please wait up to 50 minutes before restarting the analyzer. - Restart the analyzer. - Contact Radiometer service representative.
1032	Oxi data collection problem	Oxi hardware problem.	<ul style="list-style-type: none"> - Restart the analyzer. - Contact Radiometer service representative.
1033	Oxi task was not finished	Internal software problem.	<ul style="list-style-type: none"> - Restart the analyzer. - Contact Radiometer service representative.
1034	Oxi hardware problem	An Oxi hardware problem has occurred.	<ul style="list-style-type: none"> - Restart the analyzer. - Perform a calibration. - Contact Radiometer service representative.
1045	Unable to read consumable information	Unable to read information stored on either sensor cassette or solution pack.	<ul style="list-style-type: none"> - Reinstall the solution pack and sensor cassette. - Restart the analyzer. - Contact Radiometer service representative.
1061	Pressure test flow error	The sample transport through the analyzer is hindered.	The analyzer will automatically enter "Operator-intervention required". Follow the instructions shown on the screen.
1062	Pressure test pressure error	A leak has been found in the solution transport.	The analyzer will automatically enter "Operator-intervention required". Follow the instructions shown on the screen.
1063	Pressure test vacuum error	A leak has been found in the solution transport.	The analyzer will automatically enter "Operator-intervention required". Follow the instructions shown on the screen.

No.	Message	Interpretation	Action
1064	Temperature in sensor cassette top out of range	Hardware temperature error.	<ul style="list-style-type: none"> - Ensure that the ambient temperature is between 15 and 32 °C. - If the system has just performed a cold start, wait for the error to disappear. - Shield the analyzer from direct sunlight and other heat sources. - Contact Radiometer service representative.
1065	Temperature in sensor cassette bottom out of range	Hardware temperature error.	<ul style="list-style-type: none"> - Ensure that the ambient temperature is between 15 and 32 °C. - If the system has just performed a cold start, wait for the error to disappear. - Shield the analyzer from direct sunlight and other heat sources. - Contact Radiometer service representative.
1066	Temperature in sensor cassette substrate out of range	Hardware temperature error.	<ul style="list-style-type: none"> - Ensure that the ambient temperature is between 15 and 32 °C. - If the system has just performed a cold start, wait for the error to disappear. - Shield the analyzer from direct sunlight and other heat sources. - Contact Radiometer service representative.
1069	Temperature in Oxi cuvette out of range	Hardware temperature error.	<ul style="list-style-type: none"> - Ensure that the ambient temperature is between 15 and 32 °C. - If the system has just performed a cold start, wait for the error to disappear. - Shield the analyzer from direct sunlight and other heat sources. - Contact Radiometer service representative.
1070	Sensor response error	Unstable signal from sensor.	Repeat measurement
1071	Temperature in Oxi spectrometer out of range	Hardware temperature error.	<ul style="list-style-type: none"> - Ensure that the ambient temperature is between 15 and 32 °C. - If the system has just performed a cold start, wait for the error to disappear. - Shield the analyzer from direct sunlight and other heat sources. - Contact Radiometer service representative.
1079	Sensor impedance error	Sensor impedance error	<ul style="list-style-type: none"> - Perform calibration - Replace sensor cassette
1081	Inhomogeneous rinse solution	Shown in the Activity Log when "Operator-intervention required" has been entered due to this reason.	The analyzer will automatically enter "Operator-intervention required". Follow the instructions shown on the screen.

No.	Message	Interpretation	Action
1083	Inhomogeneous cal 2 solution	Shown in the Activity Log when "Operator-intervention required" has been entered due to this reason.	The analyzer will automatically enter "Operator-intervention required". Follow the instructions shown on the screen.
1084	Inhomogeneous cal 3 solution	Shown in the Activity Log when "Operator-intervention required" has been entered due to this reason.	The analyzer will automatically enter "Operator-intervention required". Follow the instructions shown on the screen.
1085	Inhomogeneous QC1 solution	Bubbles were detected in the QC1 solution.	- Perform a refill from the auxiliary program. - Replace the solution pack.
1086	Inhomogeneous QC2 solution	Bubbles were detected in the QC2 solution.	- Perform a refill from the auxiliary program. - Replace the solution pack.
1087	Inhomogeneous QC3 solution	Bubbles were detected in the QC3 solution.	- Perform a refill from the auxiliary program. - Replace the solution pack.
1089	Inhomogeneous gas	Shown in the Activity Log when "Operator-intervention required" has been entered due to this reason.	The analyzer will automatically enter "Operator-intervention required". Follow the instructions shown on the screen.
1090	No rinse solution	Shown in the Activity Log when "Operator-intervention required" has been entered due to this reason.	The analyzer will automatically enter "Operator-intervention required". Follow the instructions shown on the screen.
1092	No cal 2 solution	Shown in the Activity Log when "Operator-intervention required" has been entered due to this reason.	The analyzer will automatically enter "Operator-intervention required". Follow the instructions shown on the screen.
1093	No cal 3 solution	Shown in the Activity Log when "Operator-intervention required" has been entered due to this reason.	The analyzer will automatically enter "Operator-intervention required". Follow the instructions shown on the screen.
1094	No QC1 solution	Shown in the Activity Log when "Operator-intervention required" has been entered due to this reason.	The analyzer will automatically enter "Operator-intervention required". Follow the instructions shown on the screen.
1095	No QC2 solution	Shown in the Activity Log when "Operator-intervention required" has been entered due to this reason.	The analyzer will automatically enter "Operator-intervention required". Follow the instructions shown on the screen.
1096	No QC3 solution	Shown in the Activity Log when "Operator-intervention required" has been entered due to this reason.	The analyzer will automatically enter "Operator-intervention required". Follow the instructions shown on the screen.
1098	No gas	Shown in the Activity Log when "Operator-intervention required" has been entered due to this reason.	The analyzer will automatically enter "Operator-intervention required". Follow the instructions shown on the screen.
1099	Pump calibration error	Shown in the Activity Log when "Operator-intervention required" has been entered due to this reason.	The analyzer will automatically enter "Operator-intervention required". Follow the instructions shown on the screen.
1100	Outlet LS not empty during pump calibration	Shown in the Activity Log when "Operator-intervention required" has been entered due to this reason.	The analyzer will automatically enter "Operator-intervention required". Follow the instructions shown on the screen.
1101	Outlet LS not full during pump calibration	Shown in the Activity Log when "Operator-intervention required" has been entered due to this reason.	The analyzer will automatically enter "Operator-intervention required". Follow the instructions shown on the screen.

No.	Message	Interpretation	Action
1111	Inhomogeneous air	Shown in the Activity Log when "Operator-intervention required" has been entered due to this reason.	The analyzer will automatically enter "Operator-intervention required". Follow the instructions shown on the screen.
1112	LS inlet not empty	Shown in the Activity Log when "Operator-intervention required" has been entered due to this reason.	The analyzer will automatically enter "Operator-intervention required". Follow the instructions shown on the screen.
1113	LS sensors not empty	Shown in the Activity Log when "Operator-intervention required" has been entered due to this reason.	The analyzer will automatically enter "Operator-intervention required". Follow the instructions shown on the screen.
1114	LS outlet not empty	Shown in the Activity Log when "Operator-intervention required" has been entered due to this reason.	The analyzer will automatically enter "Operator-intervention required". Follow the instructions shown on the screen.
1115	Ws communication error: wrong message format	Internal communication error.	<ul style="list-style-type: none"> - Restart the analyzer. - Contact Radiometer service representative.
1116	Ws communication error: keep alive timeout	Internal communication error.	<ul style="list-style-type: none"> - Restart the analyzer. - Contact Radiometer service representative.
1117	Oxi spectrometer temperature drift	A large deviation in temperature has been observed. This is probably due to a change in the ambient environment.	<ul style="list-style-type: none"> - Perform a calibration
1120	Sensor replacement successful	This message is shown in the Activity Log following a successful replacement of the sensor cassette.	No action required. For information only.
1121	The port did not open during sensor replacement	This message is shown in the Activity Log after a failed sensor cassette replacement.	<ul style="list-style-type: none"> - Reinstall the sensor cassette. - Restart the analyzer. - Contact Radiometer service representative.
1123	The sensor chip data could not be read or written during replacement	This message is shown in the Activity Log after a failed sensor cassette replacement.	<ul style="list-style-type: none"> - Reinstall the sensor cassette. - Restart the analyzer. - Contact Radiometer service representative.
1124	An unregistered sensor was installed during replacement	This message is shown in the Activity Log after a sensor cassette replacement, that did not identify a previously conditioned cassette.	No action required. For information only.
1125	An unregistered and used sensor was installed during replacement	This message is shown in the Activity Log after a sensor cassette replacement. It informs that the sensor cassette installed is already used and no information exists about the conditioning hereof.	No action required. For information only.
1126	A registered sensor had been used before installation	This message is shown in the Activity Log after a sensor cassette replacement. It informs that the sensor cassette installed has been used before.	No action required. For information only.

No.	Message	Interpretation	Action
1134	The chip information for the solution pack cannot be read or written	This message is shown in the Activity Log after a failed solution pack replacement.	<ul style="list-style-type: none"> - Reinstall the solution pack. - Restart the analyzer. - Contact Radiometer service representative.
1135	The solution pack has been used before	This message is shown in the Activity Log after a failed solution pack replacement.	<ul style="list-style-type: none"> - Reinstall the solution pack.
1140	The solution pack has used the maximum number of measurements at installation	This message is shown in the Activity Log after a failed solution pack replacement.	<ul style="list-style-type: none"> - Reinstall the solution pack.
1142	The printer door is open. Printing not possible	Printer door open.	<ul style="list-style-type: none"> - Ensure that the printer paper is properly installed. - Close the printer door.
1143	Internal printer is offline. Printing not possible	Printer hardware error.	<ul style="list-style-type: none"> - Ensure that the printer paper is properly installed. - Close the printer door.
1144	Check that printer door is closed and that paper is present	Printer hardware error.	<ul style="list-style-type: none"> - Ensure that the printer paper is properly installed. - Close the printer door.
1145	A printer error has occurred. Call service technician	Printer hardware error.	<ul style="list-style-type: none"> - Ensure that the printer paper is properly installed. - Close the printer door.
1146	Printer paper replaced	This message is shown in the Activity Log after replacement of printer paper.	No action required. For information only.
1147	Inlet opened during rinse	Shown in the Activity Log when "Operator-intervention required" has been entered due to this reason.	The analyzer will automatically enter "Operator-intervention required". Follow the instructions shown on the screen.
1148	Inlet open during calibration	Shown in the Activity Log when "Operator-intervention required" has been entered due to this reason.	The analyzer will automatically enter "Operator-intervention required". Follow the instructions shown on the screen.
1149	Inlet open during wet section activity	Shown in the Activity Log when "Operator-intervention required" has been entered due to this reason.	The analyzer will automatically enter "Operator-intervention required". Follow the instructions shown on the screen.
1150	Inlet closed without aspirating sample	This message is shown in the Activity Log when a measurement has been cancelled due to inlet being closed before aspiration could be completed.	No action required. For information only.
1151	Inlet not closed: no sample aspirated	This message is shown in the Activity Log when a measurement has been cancelled due to inlet being closed too late.	No action required. For information only.

No.	Message	Interpretation	Action
1152	The solution pack chip data could not be read or written during replacement	This message is shown in the Activity Log when a replacement of the sensor cassette or solution pack has failed. The reason was that it was impossible to communicate with the chip on the consumable.	Repeat replacement operation.
1157	No valid FTC programs detected	System error.	Contact Radiometer service representative.
1160	The top termistor is not connected	The top termistor is not connected	Restart the analyzer - If still present replace top termistor
1161	The top termistor short circuited	The top termistor short circuited	Restart the analyzer - If still present replace top termistor
1163	The sensor cassette termistor is not connected	The sensor cassette termistor is not connected	Restart the analyzer - If still present replace sensor cassette
1164	The sensor cassette termistor is short circuited	Sensor cassette termistor is short circuited	Restart the analyzer - If still present replace sensor cassette
1165	Solution pack not properly installed	Shown in the Activity Log when "Operator-intervention required" has been entered due to this reason.	The analyzer will automatically enter "Operator-intervention required". Follow the instructions shown on the screen.
1166	Solution pack expired	Shown in the Activity Log when "Operator-intervention required" has been entered due to this reason.	The analyzer will automatically enter "Operator-intervention required". Follow the instructions shown on the screen.
1167	Sensor cassette not properly installed	Shown in the Activity Log when "Operator-intervention required" has been entered due to this reason.	The analyzer will automatically enter "Operator-intervention required". Follow the instructions shown on the screen.
1168	Sensor cassette expired	Shown in the Activity Log when "Operator-intervention required" has been entered due to this reason.	The analyzer will automatically enter "Operator-intervention required". Follow the instructions shown on the screen.
1169	Unable to pump solutions	Shown in the Activity Log when "Operator-intervention required" has been entered due to this reason.	The analyzer will automatically enter "Operator-intervention required". Follow the instructions shown on the screen.
1170	Inlet has been open for too long	Shown in the Activity Log when "Operator-intervention required" has been entered due to this reason.	The analyzer will automatically enter "Operator-intervention required". Follow the instructions shown on the screen.
1171	Inlet is missing or in unknown state	Shown in the Activity Log when "Operator-intervention required" has been entered due to this reason.	The analyzer will automatically enter "Operator-intervention required". Follow the instructions shown on the screen.
1172	Sensor cassette damaged	Shown in the Activity Log when "Operator-intervention required" has been entered due to this reason.	The analyzer will automatically enter "Operator-intervention required". Follow the instructions shown on the screen.
1173	Solution pack damaged	Shown in the Activity Log when "Operator-intervention required" has been entered due to this reason.	The analyzer will automatically enter "Operator-intervention required". Follow the instructions shown on the screen.
1174	Inlet opened while the analyzer was busy	Shown in the Activity Log when "Operator-intervention required" has been entered due to this reason.	The analyzer will automatically enter "Operator-intervention required". Follow the instructions shown on the screen.

No.	Message	Interpretation	Action
1175	Sensor temperature error	Hardware temperature error (Termistor).	<ul style="list-style-type: none"> - Ensure that the ambient temperature is between 15 and 32 °C. - If the system has just performed a cold start, wait for the error to disappear. - Shield the analyzer from direct sunlight and other heat sources. - Contact Radiometer service representative.
1176	A liquid sensor error was detected	Shown in the Activity Log when "Operator-intervention required" has been entered due to this reason.	The analyzer will automatically enter "Operator-intervention required". Follow the instructions shown on the screen.
1177	A flow selector error was detected	Shown in the Activity Log when "Operator-intervention required" has been entered due to this reason.	The analyzer will automatically enter "Operator-intervention required". Follow the instructions shown on the screen.
1178	A pump calibration error was detected	Shown on screen when "Operator-intervention required" has been entered due to this reason.	The analyzer will automatically enter "Operator-intervention required". Follow the instructions shown on the screen.
1180	An error occurred when trying to communicate with wet section	Shown in the Activity Log when "Operator-intervention required" has been entered due to this reason.	The analyzer will automatically enter "Operator-intervention required". Follow the instructions shown on the screen.
1181	A software or hardware error exists in wet section	Shown in the Activity Log when "Operator-intervention required" has been entered due to this reason.	The analyzer will automatically enter "Operator-intervention required". Follow the instructions shown on the screen.
1183	Valve malfunctioning	Shown in the Activity Log when "Operator-intervention required" has been entered due to this reason.	The analyzer will automatically enter "Operator-intervention required". Follow the instructions shown on the screen.
1184	Leak detected	Shown in the Activity Log when "Operator-intervention required" has been entered due to this reason.	The analyzer will automatically enter "Operator-intervention required". Follow the instructions shown on the screen.
1185	Warning: Free memory is low	The internal memory is low.	- Restart the analyzer
1186	Free system memory is critically low	The internal memory is critically low.	- Restart the analyzer
1187	Disk shows signs of wear	The permanent memory is showing exhaustion signs and should probably be replaced soon.	- Contact Radiometer service representative.
1188	Disk shows serious signs of wear	The permanent memory is showing exhaustion signs and should be replaced soon.	- Contact Radiometer service representative.
1189	FTC aborted, LS state change error	Shown in the Activity Log when "Operator-intervention required" has been entered due to this reason.	The analyzer will automatically enter "Operator-intervention required". Follow the instructions shown on the screen.
1190	Inlet open	Shown in the Activity Log when "Operator-intervention required" has been entered due to this reason.	The analyzer will automatically enter "Operator-intervention required". Follow the instructions shown on the screen.
1191	QA Portal communication enabled	Shown in the Activity Log after enabling QA Portal communication	No action required. For information only.

No.	Message	Interpretation	Action
1192	QA Portal communication disabled	Shown in the Activity Log after disabling QA Portal communication	No action required. For information only.
1193	QA Portal output queue cleared	Shown in the Activity Log when the QA Portal has been reset.	No action required. For information only.
1194	ABL not connected to QA Portal	The analyzer is not connected to the QA Portal.	<ul style="list-style-type: none"> - Contact your IT engineer. - Check QA Portal Communication Setup, including TCP/IP address, port no. and password. - Check that QA Portal is responding. - Check network connections.
1195	ABL not connected to QA Portal - incorrect password	The analyzer was refused connection to the QA Portal due to incorrect password.	Enter the correct password in the analyzer's QA Portal Communication Setup.
1196	ABL connected to QA Portal	The analyzer is connected to the QA Portal.	No action required. For information only.
1197	ABL disconnected from QA Portal	The analyzer is disconnected from the QA Portal.	No action required. For information only.
1198	ABL<>QA Portal communication error - XML packet could not be parsed	Communication error between the analyzer and the QA Portal.	Contact IT engineer or Radiometer service representative.
1199	FTC program has been retried	This message is found in the Activity Log when a measurement or calibration activity has been retried due to error.	No action required. For information only.
1200	Solution pack empty	Shown in the Activity Log when "Operator-intervention required" has been entered due to this reason.	The analyzer will automatically enter "Operator-intervention required". Follow the instructions shown on the screen.
1201	Solution pack lifetime expired	Shown in the Activity Log when "Operator-intervention required" has been entered due to this reason.	The analyzer will automatically enter "Operator-intervention required". Follow the instructions shown on the screen.
1202	Expiration date reached	Shown in the Activity Log when "Operator-intervention required" has been entered due to this reason.	The analyzer will automatically enter "Operator-intervention required". Follow the instructions shown on the screen.
1203	Lifetime in analyzer exceeded	Shown in the Activity Log when "Operator-intervention required" has been entered due to this reason.	The analyzer will automatically enter "Operator-intervention required". Follow the instructions shown on the screen.
1204	No more activities left	Shown in the Activity Log when "Operator-intervention required" has been entered due to this reason.	The analyzer will automatically enter "Operator-intervention required". Follow the instructions shown on the screen.
1216	Lifetime in analyzer exceeded	Shown in the Activity Log when "Operator-intervention required" has been entered due to this reason.	The analyzer will automatically enter "Operator-intervention required". Follow the instructions shown on the screen.
1217	No more tests left	Shown in the Activity Log when "Operator-intervention required" has been entered due to this reason.	The analyzer will automatically enter "Operator-intervention required". Follow the instructions shown on the screen.

No.	Message	Interpretation	Action
1218	Expiration date reached	Shown in the Activity Log when "Operator-intervention required" has been entered due to this reason.	The analyzer will automatically enter "Operator-intervention required". Follow the instructions shown on the screen.
1219	RiLiBÄK Violation: Value above upper limit	The measured value lies above the upper RiLiBÄK range.	No action required.
1220	RiLiBÄK Violation: Value below lower limit	The measured value lies below the lower RiLiBÄK range.	No action required.
1221	System temperature out of range	Hardware temperature error (all).	<ul style="list-style-type: none"> - Ensure that the ambient temperature is between 15 and 32 °C. - If the system has just performed a cold start, wait for the error to disappear. - Shield the analyzer from direct sunlight and other heat sources. - Contact Radiometer service representative.
1222	Temperature system error	Hardware temperature error (Top/bottom termistor).	<ul style="list-style-type: none"> - Ensure that the ambient temperature is between 15 and 32 °C. - If the system has just performed a cold start, wait for the error to disappear. - Shield the analyzer from direct sunlight and other heat sources. - Contact Radiometer service representative.
1223	Analyzer did not connect at start-up	The analyzer DMS has not been able to establish contact to the WS(M) at start-up.	<ul style="list-style-type: none"> - Restart the analyzer. - Contact Radiometer service representative.
1224	Analyzer is temporarily shut down	Shown in the Activity Log after temporary shutdown of the analyzer.	No action required.
1225	The sample is older than a day	The time between sampler draw time and aspiration is larger than 1 day.	Either sampler draw time has been entered incorrectly or time of the analyzer is incorrect. Change either to correct the error.
1226	The sample age is negative	The time between sampler draw time and aspiration is less than zero.	Either sampler draw time has been entered incorrectly or time of the analyzer is incorrect. Change either to correct the error.
1227	Correction for bicarbonate contains errors from pH, pCO ₂	Chloride is corrected for bicarbonate, calculated from pH and pCO ₂ . Errors from pH, pCO ₂ results in this error on chloride.	No action required.
1228	Correction for lactate contains errors from K ⁺ , Na ⁺ , Ca ²⁺	Lactate is corrected for ion strength, calculated from K ⁺ , Na ⁺ , Ca ²⁺ . Errors from K ⁺ , Na ⁺ , Ca ²⁺ results in this error on lactate.	No action required.
1230	Inlet Gasket Holder replaced	Shown in the activity log at the time of a replacement.	No action required.

No.	Message	Interpretation	Action
1231	Inlet probe replaced	Shown in the activity log at the time of a replacement.	No action required.
1232	Inlet Connector Gasket replaced	Shown in the activity log at the time of a replacement.	No action required.
1233	Inlet cleaned	Shown in the activity log at the time when an inlet cleaning was performed.	No action required.
1234	Demonstration software - not for clinical purposes	Demonstration software - not for clinical purposes	No action required.
1235	Failed to aspirate sample	Aspiration failed	Remove sampler. Retry aspiration
1236	Failed to aspirate sample	Aspiration failed, due to blocked inlet	Remove sampler. Retry aspiration
1240	Liquid transport failed	Unstable aspiration from solution pack	No action required
1242	Liquid transport failed	Unstable aspiration from solution pack	No action required
1243	Liquid transport failed	Unstable aspiration from solution pack	No action required
1244	Liquid transport failed	Unstable aspiration from solution pack	No action required
1245	Liquid transport failed	Unstable aspiration from solution pack	No action required
1246	Liquid transport failed	Unstable aspiration from solution pack	No action required
1247	Liquid transport failed	Unstable aspiration from solution pack	No action required
1248	Liquid transport failed	Unstable aspiration from solution pack	No action required
1249	Liquid transport failed	Unstable aspiration from solution pack	No action required
1250	Liquid transport failed	Unstable aspiration from solution pack	No action required
1253	Failed to aspirate sample	Aspiration failed sample not detected	Retry aspiration
1254	Failed to aspirate sample	Aspiration failed sample not detected	Retry aspiration
1257	Liquid transport failed	Unstable aspiration from solution pack	No action required
1258	Liquid transport failed	Unstable aspiration from solution pack	No action required
1259	Liquid transport failed	Unstable aspiration from solution pack	No action required

No.	Message	Interpretation	Action
1260	Liquid transport failed	Unstable aspiration from solution pack	No action required
1261	Liquid transport failed	Unstable aspiration from solution pack	No action required
1262	Liquid transport failed	Unstable aspiration from solution pack	No action required
1263	Liquid transport failed	Unstable aspiration from solution pack	No action required
1264	Liquid transport failed	Unstable aspiration from solution pack	No action required
1265	Liquid transport failed	Unstable aspiration from solution pack	No action required
1266	Liquid transport failed	Unstable aspiration from solution pack	No action required
1267	Liquid transport failed	Unstable aspiration from solution pack	No action required
1268	Liquid transport failed	Unstable aspiration from solution pack	No action required
1271	Failed to aspirate sample	Aspiration failed sample not detected	Retry aspiration
1272	Failed to aspirate sample	Aspiration failed sample not detected	Retry aspiration
1275	Liquid transport failed	Unstable aspiration from solution pack	No action required
1276	Liquid transport failed	Unstable aspiration from solution pack	No action required
1279	Liquid transport failed	Unstable aspiration from solution pack	No action required
1280	Liquid transport failed	Unstable aspiration from solution pack	No action required
1281	Liquid transport failed	Unstable aspiration from solution pack	No action required
1282	Liquid transport failed	Unstable aspiration from solution pack	No action required
1283	Liquid transport failed	Unstable aspiration from solution pack	No action required
1284	Liquid transport failed	Unstable aspiration from solution pack	No action required
1285	Liquid transport failed	Unstable aspiration from solution pack	No action required
1286	Liquid transport failed	Unstable aspiration from solution pack	No action required
1290	Liquid transport failed	Unstable aspiration from solution pack	No action required

No.	Message	Interpretation	Action
1292	Liquid transport failed	Unstable aspiration from solution pack	No action required
1294	Liquid transport failed	Unstable aspiration from solution pack	No action required
1295	Activity has been repeated due to the following reason:	This message is shown in the activity log when an activity is repeated automatically. It lists the error and parameter id that was the cause of the repeat.	No action required.
1296	Printer out of paper	The printer is out of paper. A new paper roll must be inserted	- Insert a new paper roll
1297	Printer is offline	The printer is offline due to either a bad or missing power / USB connection	- Check the power connection - Check the USB connection - Contact Radiometer service representative.
1298	Printer lid open	The printer lid is open	- Close the printer lid
1299	Rinse activity repeated:	A rinse activity has been repeated. The following entries in the log explains the reason for the repeat.	No action required.
1300	Calibration activity repeated:	A calibration activity has been repeated. The following entries in the log explains the reason for the repeat.	No action required.
1301	QC activity repeated:	A QC activity has been repeated. The following entries in the log explains the reason for the repeat.	No action required.
1302	Startup activity repeated:	A startup activity has been repeated. The following entries in the log explains the reason for the repeat.	No action required.
1303	Activity repeated:	An activity has been repeated. The following entries in the log explains the reason for the repeat.	No action required.
1304	Calibration activity repeated	A calibration activity has been repeated. The following entries in the log explains the reason for the repeat.	No action required.
1305	End of repeat reason list	This message indicates the end of repeat reasons. See errors 1299-1304.	No action required.
1306	Solution pack manually removed	Shown in the Activity Log when "Operator-intervention required" has been entered due to this reason.	The analyzer will automatically enter "Operator-intervention required". Follow the instructions shown on the screen.
1307	Disk space less than fifteen percent	The disk space on the analyzer is low.	Delete some archives to free up space on the drive.
1308	Disk space less than one percent	The disk space on the analyzer is less than 1 %	Contact service technician
1309	Unable to start FTC activity - FTC activity in progress	Unable to start FTC activity	Contact service technician
1310	Response error	Sensor (Metabolit) does not work properly	Replace sensor

No.	Message	Interpretation	Action
1311	The analyzer chip data could not be read or written	It's not possible to read or write data to the analyzer chip	Contact Radiometer service representative.
1312	Export data logs failed	The export data log operation has failed.	- Make sure the selected export path exists. - Make sure enough space is available.
1313	Export data logs done	The export data log operation has completed successfully.	No action required.
1314	Sensor temperature error during rinse	Sensor temperature error (substrate) during rinse	- Check sensor status and replace, if necessary.
1315	Cal backlog error (pH)	Cal backlog error (pH), leaping signals on rinse	Perform rinse
1316	Cal backlog error (pCO ₂)	Backlog unstable, leaping signals on rinse	Perform rinse
1317	Cal backlog error (pO ₂)	Backlog unstable, leaping signals on rinse	Perform rinse
1318	Cal backlog error (K)	Backlog unstable, leaping signals on rinse	Perform rinse
1319	Cal backlog error (Na)	Backlog unstable, leaping signals on rinse	Perform rinse
1320	Cal backlog error (Ca)	Backlog unstable, leaping signals on rinse	Perform rinse
1321	Cal backlog error (Cl)	Backlog unstable, leaping signals on rinse	Perform rinse
1322	Cal backlog error (Glu)	Backlog unstable, leaping signals on rinse	Perform rinse
1323	Cal backlog error (Lac)	Backlog unstable, leaping signals on rinse	Perform rinse
1324	Inhomogeneous rinse solution (LS sensors)	Shown in the Activity Log when "Operator-intervention required" has been entered due to this reason.	The analyzer will automatically enter "Operator-intervention required". Follow the instructions shown on the screen.
1325	Sensor thermistor recalibrated	Show in activity log when a recalibration of the sensor thermistor has been performed	Information only
1326	Sensor thermistor recalibration failed - thermistor mal-functioning	Shown in the Activity Log when "Operator-intervention required" has been entered due to this reason.	The analyzer will automatically enter "Operator-intervention required". Follow the instructions shown on the screen.
1327	Analyzer locked by operator	Operator has locked the analyzer	No action required.
1328	Analyzer locked on request from LIS	The analyzer was locked on request from LIS	No action required.
1329	Analyzer locked on request from Radiance	The analyzer was locked on request from Radiance	No action required.

No.	Message	Interpretation	Action
1330	pO2 substrate thickness	The thickness of the pO2 substrate is outside the ranges	-Perform calibration -Replace sensor cassette
1331	Intervention required entered	The analyzer enters UIR	No action required.
1332	Intervention required exited	The analyzer exits UIR	No action required.
1335	Solution pack replaced	This message is used in the Activity log to indicate replacement of solution pack	No action required
1336	Sensor cassette replaced	This message is used in the Activity log to indicate replacement of sensor cassette	No action required
1337	Printer paper replaced	This message is used in the Activity log to indicate replacement of printer paper	No action required
1338	Demo mode enabled	This message is used in the Activity log to indicate that ABL 90 demo mode has been enabled	No action required
1339	Demo mode disabled	This message is used in the Activity log to indicate that ABL 90 demo mode has been disabled	No action required
1340	Sensor cassette maintenance by Analyzer has been interrupted	This message is used in the Activity log to indicate startup using a sensor cassette which has been left without an FTC activity for more than 2 hour.	No action required
1341	Leak detected	Shown in the Activity Log when "Operator-intervention required" has been entered due to this reason.	The analyzer will automatically enter "Operator-intervention required". Follow the instructions shown on the screen.
1342	Leak detected	Shown in the Activity Log when "Operator-intervention required" has been entered due to this reason.	The analyzer will automatically enter "Operator-intervention required". Follow the instructions shown on the screen.
1343	Unable to pump solutions	Shown in the Activity Log when "Operator-intervention required" has been entered due to this reason.	The analyzer will automatically enter "Operator-intervention required". Follow the instructions shown on the screen.
1344	Solution pack removed	This message is used in the Activity log to indicate replacement of solution pack	No action required
1345	Solution pack inserted	This message is used in the Activity log to indicate replacement of solution pack	No action required
1346	Sensor cassette removed	This message is used in the Activity log to indicate replacement of sensor cassette	No action required
1347	Sensor cassette inserted	This message is used in the Activity log to indicate replacement of sensor cassette	No action required
1348	Warning - Battery low	This message is used in the Activity log to indicate low battery level	Plug analyzer into mains
1349	Analyzer shutdown due to low battery	Analyzer shutdown due to low battery	No action required

No.	Message	Interpretation	Action
1350	Clot suspected in Inlet	Clot suspected in Inlet	No action required
1351	Clot suspected in sensor cassette	Clot suspected in sensor cassette	No action required
1352	Clot suspected in OXI module	Clot suspected in OXI module	No action required
1353	Operator Action Needed entered	The analyzer has entered Operator Action Needed	Operator should perform action shown on screen
1354	Operator Action Needed exited	The analyzer has exited Operator Action Needed	No action required
1355	Conditioned Sensor Startup	Conditions for performing a conditioned sensor startup was fulfilled. The analyzer does not initially perform calibration with every measurement.	No action required
1356	Non-Conditioned Sensor Startup	Conditions for performing a conditioned sensor startup was fulfilled. The analyzer does not initially perform calibration with every measurement.	No action required
1357	Software upgrade initiated	This message is shown in the activity log when a software upgrade has been initiated	No action required
1358	Upgraded from	This message is shown in the activity log when a software upgrade has been performed	No action required
1359	Upgrade option:	This message is shown in the activity log when a software upgrade has been performed	No action required
1360	No clots detected in Analyzer	This message is shown in the activity log when the clot detection program did not detect any clots	No actions
1361	Internal reference electrode error in sensor cassette	The reference electrode is malfunctioning.	Replace sensor cassette
1362	Inlet gasket cleaning has been started	Guided troubleshooting step has been started by operator	No action required
1363	Inlet gasket cleaning has been skipped	Guided troubleshooting step has been skipped by operator	No action required
1364	Inlet gasket cleaning test ok	Test after action by operator is ok	No action required
1365	Inlet gasket cleaning test failed	Test after action by operator has failed	No action required
1366	Inlet gasket holder replacement has been started	Guided troubleshooting step has been started by operator	No action required

No.	Message	Interpretation	Action
1367	Inlet gasket holder replacement has been skipped	Guided troubleshooting step has been skipped by operator	No action required
1369	Inlet gasket holder replacement test failed	Test after action by operator has failed	No action required
1371	Solution pack replacement skipped	Guided troubleshooting step has been skipped by operator	No action required
1372	Solution pack replacement test ok	Test after action by operator is ok	No action required
1373	Solution pack replacement test failed	Test after action by operator has failed	No action required
1374	Inlet connector gasket replacement started	Guided troubleshooting step has been started by operator	No action required
1375	Inlet connector gasket replacement skipped	Guided troubleshooting step has been skipped by operator	No action required
1376	Inlet connector gasket replacement test ok	Test after action by operator is ok	No action required
1377	Inlet connector gasket replacement test failed	Test after action by operator has failed	No action required
1378	Inlet gasket holder replacement test ok	Test after action by operator is ok	No action required
1379	Solution pack replacement started	Guided troubleshooting step has been started by operator	No action required
1380	Manual flush started	Guided troubleshooting step has been started by operator	No action required
1381	Manual flush skipped	Guided troubleshooting step has been skipped by operator	No action required
1382	Manual flush test ok	Test after manual flush is ok	No action required
1383	Manual flush test failed	Test after manual flush has failed	No action required
1384	Replace inlet gasket holder	The inlet gasket holder needs to be replaced.	Replace inlet gasket holder
1386	System time adjusted more than 2 hours	No action	No action
1387	Glu not usable	pO ₂ too low for reliable cGlucose measurement	N/A

No.	Message	Interpretation	Action
1388	Low Wi-Fi signal quality	Low Wi-Fi signal quality detected	No action required.
1389	Unsupported Wi-Fi configuration	Wi-Fi USB adapter and/or configuration not supported	No action required.
1390	Inlet cannot be closed	The inlet cannot be closed	- Remove any blocking items - Contact Radiometer service representative
1391	Inlet is not in the correct position	The inlet is not in the correct position	- Contact Radiometer service representative
1392	Remove sampling device	The inlet cannot be closed before the sampling device is removed	- Remove sampling device - Contact Radiometer service representative
1393	Inlet is not mounted	The analyzer has no inlet module installed	- Install the inlet module - Contact Radiometer service representative
1394	Calibration of the inlet failed	The analyzer could not calibrate the inlet	- Contact Radiometer service representative
1396	Sensor cassette replacement is recommended	Sensor cassette replacement is recommended	Replace sensor cassette
1397	Solution pack replacement recommended	Solution pack replacement recommended	Replace solution pack
1398	Recommended action removed	Recommended action removed. Just info	No action needed
1399	Inlet Cover is attached	Inlet Cover attached	No action just info
1400	Inlet Cover is removed	Inlet Cover removed	No action just info
1401	Inlet Gasket Holder error	Inlet Gasket Holder did not return to expected position after aspiration	Remove/replace the Inlet Gasket Holder
1402	pO ₂ too low. cGlucose Linearity out of range.	At pO ₂ levels <25 mmHg, glucose linearity is out of range at high glucose concentrations	When a sample has low pO ₂ levels and cGlu is required, repeat the measurement with an arterial sample
1403	Run ampoule-based QC measurements	Ampoule-based QC measurements must be done after Solution Pack replacements	Do ampoule-based QC measurements
1404	Run ampoule-based QC measurements	Ampoule-based QC measurements must be done after Sensor Cassette replacements	Do ampoule-based QC measurements
1405	Inconsistent database	QC lot numbers in the database do not match those read from the smart chip in the Solution Pack	Do the Solution Pack replacement procedure again with the same Solution Pack. Restart the analyzer.
1406	The analyzer is not horizontal	The analyzer is not on a horizontal surface	Put the analyzer on a horizontal surface

No.	Message	Interpretation	Action
1528	Clot suspected in sensor cassette	Clot suspected in sensor cassette	No action required
1529	Clot suspected in sensor cassette	Clot suspected in sensor cassette	No action required
1530	Clot suspected in sensor cassette	Clot suspected in sensor cassette	No action required
1531	Clot suspected in sensor cassette	Clot suspected in sensor cassette	No action required
1532	Clot suspected in sensor cassette	Clot suspected in sensor cassette	No action required
1533	Clot suspected in sensor cassette	Clot suspected in sensor cassette	No action required
1534	Clot suspected in sensor cassette	Clot suspected in sensor cassette	No action required
1535	Clot suspected in sensor cassette	Clot suspected in sensor cassette	No action required
1536	Clot suspected in sensor cassette	Clot suspected in sensor cassette	No action required
1537	Clot suspected in sensor cassette	Clot suspected in sensor cassette	No action required
1538	Inhomogeneous cal 2 solution	Shown in the Activity Log when "Operator-intervention required" has been entered due to this reason.	The analyzer will automatically enter "Operator-intervention required". Follow the instructions shown on the screen.
1539	Inhomogeneous cal 3 solution	Shown in the Activity Log when "Operator-intervention required" has been entered due to this reason.	The analyzer will automatically enter "Operator-intervention required". Follow the instructions shown on the screen.
1540	Inhomogeneous QC1 solution	Bubbles were detected in the QC1 solution.	- Perform a refill from the auxiliary program. - Replace the Solution Pack.
1541	Inhomogeneous QC2 solution	Bubbles were detected in the QC2 solution.	- Perform a refill from the auxiliary program. - Replace the Solution Pack.
1542	Inhomogeneous QC3 solution	Bubbles were detected in the QC3 solution.	- Perform a refill from the auxiliary program. - Replace the Solution Pack.
1543	Inhomogeneous gas	Shown in the Activity Log when "Operator-intervention required" has been entered due to this reason.	The analyzer will automatically enter "Operator-intervention required". Follow the instructions shown on the screen.
1544	Inhomogeneous air	Shown in the Activity Log when "Operator-intervention required" has been entered due to this reason.	The analyzer will automatically enter "Operator-intervention required". Follow the instructions shown on the screen.

Activity log

About the Activity log

The **Activity log** is where activities done on or by the analyzer are saved.

To troubleshoot messages in the Activity log

1. Tap **Menu** > **Data logs** > **Activity log**.
2. Select the message.
3. Tap the **Troubleshoot** button.
4. Follow the instructions on the screen.

To see activities in the Activity log

1. Tap **Menu** > **Data logs** > **Activity log**.

To add a message to the Activity log

1. Tap **Menu** > **Data logs** > **Activity log**.
2. Tap the **Add message** button.
3. Enter the message.
4. Tap the **Close** button.

To filter activities from the Activity log

1. Tap **Menu** > **Data logs** > **Activity log**.
2. Tap the **Filter** button.
3. In the **Criteria** frame, choose an option and follow the steps for it.

Option	Steps
To select a time period prior to today's date	Tap the number button for the number of days you want
To select a start and end date	Enter data in the Start date: and End date: fields

4. Select the next criterion. If necessary, enter or select a value for it.
5. If necessary, do step 4 again.
6. Tap the **Apply** button.

Analyzer service

For service

For service, contact your local Radiometer representative. You may have to supply the installation number (serial number) of the analyzer and the version number of the installed software.

To find the installation number (serial number) of the analyzer

1. Tap **Menu > Utilities > Setup > General setup > Analyzer settings > Analyzer ID.**
2. Read the installation number (serial number) on the screen.

Note: The installation number can also be found on printouts of QC, Calibration and Patient results and on printouts from data logs.

To find the version of software installed

1. Tap **Menu > Analyzer status.**
2. Read the software version in the lower left corner of the screen.

Shutting down, moving and restarting the analyzer

8

Shutdown

Shutdown is a safe procedure for you to close down the analyzer. There are 2 procedures a **Temporary shutdown** and a **Long term shutdown**.

Note: Do not use the power switch to shut down the analyzer.

Temporary shutdown of the analyzer

When to do a temporary shutdown

Usually, the analyzer is kept switched on so that it is ready to use at any time. However, in some situations, it is necessary to do a temporary shutdown:

- When an analyzer without a battery must be moved to a new location
- When an analyzer with a low-charge level battery must be moved to a new location
- When the analyzer tells you to do a shutdown (for example, during a troubleshooting procedure)
- After a non-USB keyboard or mouse is connected to an analyzer that is switched on.

Note: If the analyzer is shut down for more than 2 hours, the Sensor Cassette must be replaced.

To do a temporary shutdown

1. Tap **Menu > Utilities > Temporary shutdown**.
2. Tap the **Confirm shutdown** button.
3. Wait until the Windows program tells you that it is shutting down.
4. When Windows program has shut down, push the analyzer power switch to the Off position (O).

Long-term shutdown of the analyzer

When to do a long-term shutdown

It is usually only necessary to do a long-term shutdown when the analyzer is stored.

To do a long-term shutdown

Prerequisites:

- The Inlet Module has been cleaned
- A syringe filled with S5362 Hypochlorite Solution
- A syringe filled with distilled water

Note: Approximately 15 minutes are necessary for this procedure.

Note: The Sensor Cassette used during this procedure must not be used again.

1. Tap **Menu > Utilities > Long term shutdown.**
2. Tap the **OK** button.
3. Hold the syringe with the S5362 Hypochlorite Solution by its barrel.
4. Lift the inlet handle to the syringe position.

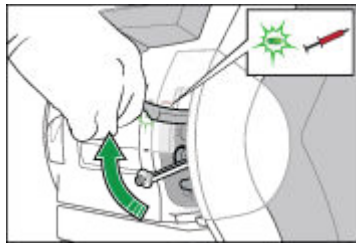

5. Follow the instructions on the screen.
6. Place and hold the tip of the syringe in the center of the inlet gasket.
7. Push the syringe into the analyzer as far as it will go and hold it there.

Note: Be careful not to bend the Inlet Probe.

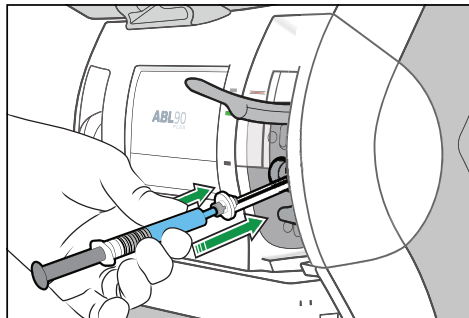

8. Hold the syringe in the pushed-in position until the analyzer tells you that the aspiration is completed.

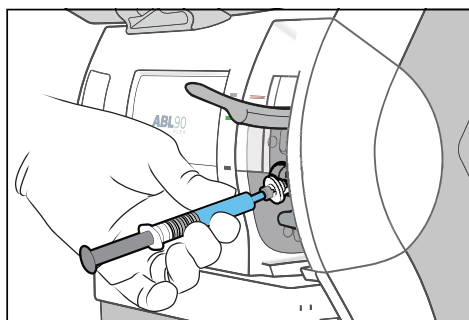

- 9. When the analyzer tells you that the aspiration is completed, remove the syringe.
- 10. Close the inlet.
- 11. Hold the syringe with distilled water by its barrel.
- 12. When the analyzer tells you to, do steps 6 to 10 again.
- 13. Wait until the Sensor Cassette compartment opens.
- 14. Remove the Sensor Cassette and dispose of it as biohazardous waste.



- 15. Tap the **Confirm removal** button.
- 16. When the analyzer tells you to, lift the inlet handle to the capillary position.

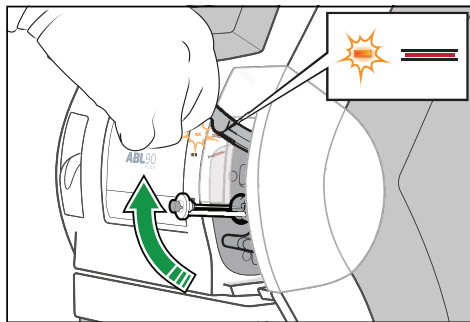

- 17. Wait until the Solution Pack is ejected.
- 18. Remove the Solution Pack and dispose of it as biohazardous waste.

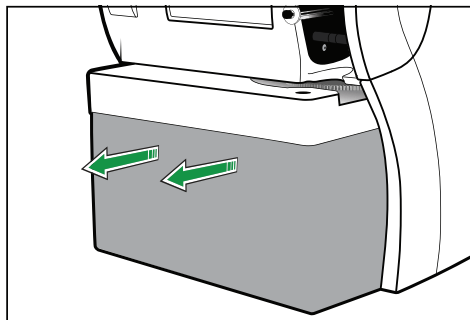

- 19. Close the inlet.
- 20. Wait until the Windows program tells you that it is shutting down.
- 21. When the Windows program has shut down, push the analyzer power switch to the Off position (O).

Related information

Can a Solution Pack be used again?, page 38

Storing the analyzer

To store the analyzer

1. Do a long-term shutdown.
2. Put a dustcover on the analyzer.
3. Store the analyzer between -20 °C and 60 °C.

Moving the analyzer

To move an analyzer that has a charged battery

Note: The charge level of the battery must be high enough to be able to move the analyzer and connect it to the mains power supply before the charge level drops below 11 %.

1. Disconnect the power cable and peripheral devices.
2. Lift the analyzer by its handle, keep it vertical and move it to its new location.
3. Connect the power cable and peripheral devices to the analyzer.
4. Connect the analyzer to the mains power supply before the analyzer battery charge-level falls below 10 %.

To move an analyzer that does not have a battery

1. Do a temporary shutdown.
2. Disconnect the power cable and peripheral devices.
3. Lift the analyzer by its handle, keep it vertical and move it to its new location.
4. Connect the power cable and peripheral devices.
5. Switch on the mains power supply.
6. Push the power switch to the On position (I).
7. If the analyzer does not restart, press the standby button on the back of the analyzer.

Restarting the analyzer

To restart the analyzer after a temporary shutdown

1. Push the power switch to the On position (I).
2. If the analyzer does not restart, press the standby button on the back of the analyzer

Note: The analyzer is ready for use when it is **Ready**.

To restart the analyzer after a long-term shutdown

Prerequisites:

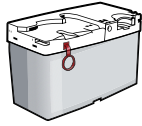

A Solution Pack



A Sensor Cassette

1. Use the power cable to connect the analyzer to the mains power supply.
2. Push the power switch to the On position (I) and wait until the **Operator-intervention required** screen is shown.
3. If the analyzer does not restart, press the standby button on the back of the analyzer.
4. Install a Solution Pack.
5. Install a Sensor Cassette.
6. Tap the **Test again** button.
The analyzer is ready for use when it is **Ready**.

Setup menu structure

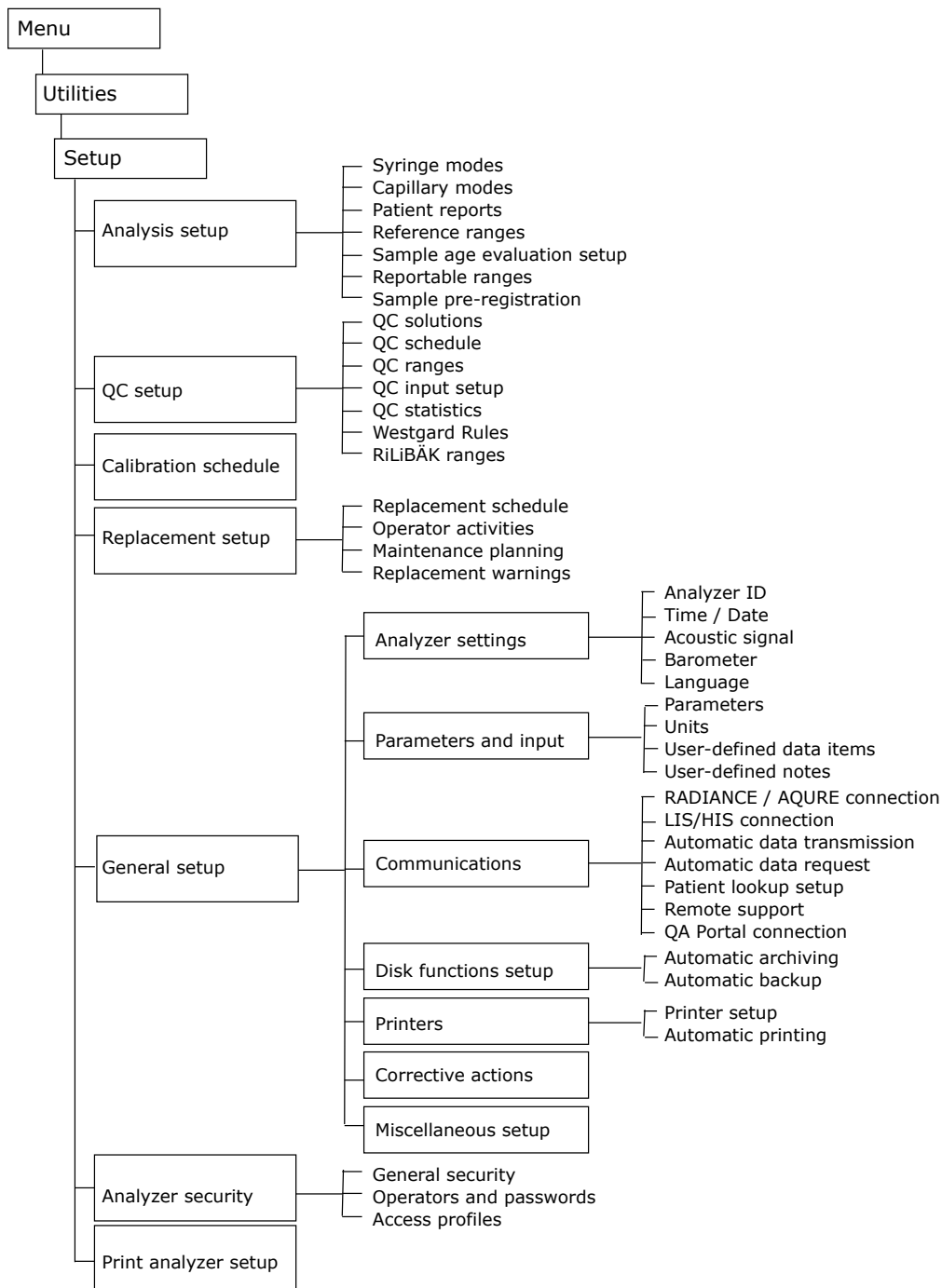

To print setups

1. Tap **Menu > Utilities > Setup > Print analyzer setup**.
2. Deselect the check buttons for the setups you do not want to print.
3. Tap the **Print** button.
4. If necessary, select the printer and tap the **Select printer** button.
5. Tap the **Close** button.

Managing operators

To select the logon procedure

1. Tap **Menu > Utilities > Setup > Analyzer security > General security**.
2. In the **Authenticate operator by** field, select the option you want.

Option	Action
To let most operators log on with an Operator name: and Password: , but let some operators log on with a logon barcode	Select "Operator ID / password as primary"
To let most operators log on with a logon barcode, but let some operators log on with an Operator name: and Password:	Select "Logon-barcode as primary"
To only let operators log on with an Operator name: and Password:	Select "Operator ID / password only"
To only let operators log on with a logon barcode	Select "Logon-barcode only"

3. Tap the **Close** button.

Access profiles

An access profile specifies what an operator with the given profile can do on the analyzer.

- The operations that can be done
- The menus and screens that can be opened
- The shortcut buttons that are available to operators

Eight access profiles are available. Access profiles may be edited, but their names cannot be changed. No new access profiles can be created. An access profile must be selected for each operator.

To edit an access profile

Note: All access profiles may be edited, but some only in part.

1. Tap **Menu > Utilities > Setup > Analyzer security > Access profiles**.
2. Select the access profile.
3. Select the check buttons in the **Permitted actions for selected profile** field.
4. Tap the **Menu and buttons for selected profile** button.

5. To create a shortcut button.
 - Note:** You can create a shortcut button to six menus.
 - a) In the **Available menu items:** field, select the menu you want a shortcut button for.
 - b) In the **Button shortcuts** field, select a button position for the shortcut.
 - c) Do these steps again for each shortcut button you want to create.
6. To create access to menus.
 - a) In the **Available menu items:** field, select the menu that you want to create access to.
 - b) Tap the **Select / Deselect** button.
 - Note:** Make sure a checkmark is shown in the selected check box.
 - c) Do these steps again for each menu you want to create access to.
7. Tap the **Back > Close** buttons.

Anonymous use

Operators do not have to log on to an analyzer that is set up for anonymous use. The access profile selected for anonymous use specifies the shortcut buttons and menus that anonymous operators can use.

To set up anonymous use

1. Tap **Menu > Utilities > Setup > Analyzer security > General security.**
2. Select the **Allow anonymous use** check button.
3. Select an access profile for anonymous operators.
4. Tap the **Close** button.

Default operators

Some operators are set up by default.

Operator	Default access to menus	Can the operator be deleted?
Manager	See the default "Manager" access profile. Note: The password 123456 lets you log on to the analyzer the first time the analyzer is used.	Yes
Radiometer	All operator and service menus.	No
Remote operator	All operator and service menus. Note: A remote operator cannot by default view patient data. Note: This operator is only shown when you have the "Remote support" option. Contact your local Radiometer representative for details.	No

To add an operator

1. Tap **Menu > Utilities > Setup > Analyzer security > Operators and passwords.**
2. Tap the **Add operator** button.

3. Choose an option and follow the steps for it.

Option	Steps
To let the operator log on with an Operator name: and a Password:	<p>a) Enter a unique ID for the operator.</p> <p>Note: Only enter 35 characters, so that the complete ID is seen in the Logon screen.</p> <p>Note: Do not include characters such as apostrophes (') and slashes (/).</p> <p>b) Enter the password for the operator.</p> <p>Note: The password must contain a minimum of 4 characters.</p> <p>c) Enter the password again in the Confirm: field below the Password: field.</p>
To let the operator log on with a logon barcode	<p>a) Enter or scan in the logon barcode for the operator.</p> <p>Note: The logon barcode must be unique and contain a minimum of 4 characters.</p> <p>b) Enter or scan in the logon barcode again in the Confirm field below the Logon - barcode: field.</p>
To let the operator log on with an Operator name: and a Password: or with a logon barcode	<p>a) Enter a unique ID for the operator.</p> <p>Note: Do not include characters such as apostrophes (') and slashes (/).</p> <p>Note: Only enter 35 characters, so that the complete ID is seen in the Logon screen.</p> <p>b) Enter the password for the operator.</p> <p>Note: The password must contain a minimum of 4 characters.</p> <p>c) Enter or scan in the password again in the Confirm: field below the Password: field.</p> <p>d) Enter or scan in the logon barcode for the operator.</p> <p>Note: The logon barcode must be unique and contain a minimum of 4 characters.</p> <p>e) Enter or scan in the logon barcode again in the Confirm field below the Logon - barcode field.</p>

4. Tap the **Back** button.
- Note:** If data is not valid, a pop-up message is shown and an acoustic signal is sent.
5. Make sure that the operator is selected.
6. Select an access profile for the selected operator.
7. Tap the **Close** button.

To remove an operator

1. Tap **Menu > Setup > Analyzer security > Operators and passwords.**
2. Select the operator.
3. Tap the **Remove operator** button.
4. Tap the **Close** button.

To set a logoff time for all operators

Note: If no time is set, operators will be automatically logged off after 3 minutes. The maximum logoff time that can be set is 60 minutes and 50 seconds.

1. Tap **Menu > Utilities > Setup > Analyzer security > General Security**.
2. Tap the **Log off time** button.
3. Set a logoff time in minutes and seconds.
4. Tap the **Back > Close** buttons.

Centralized user management

Centralized user management lets a connected AQUIRE/RADIANCE system do some of the management procedures usually done on the analyzer. The table shows which procedures will have to be done on the connected AQUIRE/RADIANCE system if centralized user management is set up.

Procedures	Done on the AQUIRE/RADIANCE system	Done on the analyzer*
Add new operator	X	
Select an access profile for a new operator	X	
Remove operators	X	
Select the logon procedure		X
Set up anonymous use of the analyzer		X
Edit an access profile		X
Set the logoff time for all operators		X

* These procedures can also be done remotely from a connected AQUIRE/RADIANCE system.

To set up centralized user management

Note: We recommend that you use the same set of rules to add analyzer operators to the AQUIRE/RADIANCE system as you use to add operators to the analyzer. If centralized user management is then disabled, operators can continue to log on.

1. In the connected AQUIRE/RADIANCE system, add present operators of the analyzer as present operators in the AQUIRE/RADIANCE system.
Note: This is important because when centralized user management is set up, all operator data in the analyzer is overwritten by data received from the AQUIRE/RADIANCE system. Only present operators in the AQUIRE/RADIANCE system can log on to the analyzer.
2. Tap **Menu > Utilities > Setup > Analyzer security > General security**.
3. Select the **Enable centralized user management** check button.
4. Select the **Close** button.

Note: This will have no effect on the activities in progress.

Managing patient profiles

Patient profiles log

A patient profile contains data that helps to identify a patient. This data is automatically saved in the **Patient profiles log** during sample analysis.

If a **Patient ID** is included in a profile, the analyzer will download all the other patient profile data to the **Patient identification** screen, when the **Patient ID** field is filled in. If the analyzer is set up to automatically request patient data from a LIS/HIS system, data received from the LIS/HIS system updates data in the screen and in the log.

To see the data saved in a patient profile

1. Tap **Menu** > **Data logs** > **Patient profiles log**
2. Select the patient.
3. Tap the **Edit** button.

To find a patient profile

1. Tap **Menu** > **Data logs** > **Patient profiles log**.
2. Tap the **Find** button.
3. Select the field of the criterion you want to use to find the patient profile. For example **Patient ID**.
4. Enter data in the field.
5. Tap the **Find** button.

To edit a patient profile

1. Tap **Menu** > **Data logs** > **Patient profiles log**.
2. Select the patient profile.
3. Tap the **Edit** button.
4. Edit the values you want to edit.
5. Tap the **Back** > **Close** buttons.

To add a new patient profile

1. Tap **Menu** > **Data logs** > **Patient profiles log**.
2. Tap the **Add** button.
3. Enter data in the **Patient ID** field.
4. Enter data in other fields that help to identify the patient.
5. Tap the **Back** > **Close** buttons.

To delete a patient profile

1. Tap **Menu** > **Data logs** > **Patient profiles log**.
2. Select the patient profile.
3. Tap the **Delete** button.
4. Tap the **Close** button.

Analyzer operations

To lock the analyzer

No samples can be analyzed when the analyzer is locked. However, the analyzer will continue to do automatic calibrations.

1. Tap **Menu > Utilities > Setup > General setup > Miscellaneous setup**.
2. Select the **Analyzer locked** check button.
3. Tap the **Close** button.

To unlock the analyzer

This procedure lets you unlock the analyzer when an operator has locked it.

Note: To unlock an analyzer that is set up to lock automatically after a Solution Pack and/or Sensor Cassette replacement: Operators must do the requested ampoule-based QC measurements.

1. Tap **Menu > Utilities > Setup > General setup > Miscellaneous setup**.
2. Deselect the **Analyzer locked** check button.
3. Tap the **Close** button.

To lock/unlock parameters for measurement

A locked parameter cannot be measured. When a parameter is locked, the parameter tab changes to red and no values are given for the parameter in result screens or in printouts. However, locked parameters continue to be calibrated.

1. Tap **Menu > Utilities > Setup > General setup > Parameters and input > Parameters**.
2. Select the parameter.
3. Tap the **Lock/ Unlock** button.

Note: The last value in the **Enabled/locked** column must be "Yes" to lock the parameter, and "No" to unlock it.

4. Tap the **Close** button.

To show a message on the analyzer screen

The message is shown in the start screen.

1. Tap **Menu > Utilities > Setup > General setup > Miscellaneous setup**.
2. Enter a message in the **Analyzer message** frame.
3. Tap the **Close** button.

Sample counter

To see an overview of measurements and tests done on the analyzer

1. Menu > Utilities > Sample counter.

Sample counter

The **Sample counter** screen gives an overview of the measurements and tests done on the analyzer.

Data	Description
Parameter, Count	Shows the number of tests done for each parameter on patient samples and QC solutions
Total column	Shows the number of completed patient sample analyses, calibrations and QC measurements. Note: Because a parameter can be removed from a measurement, the total number of completed measurements may not be equal to the total number of tests.
Aborted column	Shows the number of measurements stopped by the analyzer because it found an error
User column	The number of measurements done since the user counters were last set to zero
User counters last reset	Shows the date when the counters in the User column were last reset to zero

To reset the counters in the User column

Note: The counter in the **User** column is the only counter that can be reset (set to zero).

1. Tap the **Menu > Utilities > Sample counter**.
2. Tap the **Reset counters** button.

Analyzer settings

To set up corrective actions on system messages

Two corrective actions are available for system messages.

- Select the color of traffic light shown on the left side of the **System messages** button in the **Analyzer status** screen
- Attach a message about the system message to the next patient result

1. Tap **Menu > Utilities > Setup > General setup > Corrective actions**.
2. Select the condition "System message(s) present".
3. Choose an option and follow the steps for it.

Option	Steps
To change the traffic light color	a) Tap the traffic light until it shows the color you want.
To attach a message to the next patient result	a) Select the Message on next patient result check button.

To enable data to be scanned from barcodes

This procedure lets operators scan barcodes to enter data into more text fields than the **Patient ID**, **Accession no.** and **Sampler ID** text fields.

1. Tap **Menu > Utilities > Setup > General setup > Miscellaneous setup**.
2. Select the **Enable general barcode support** check button.
3. Tap the **Close** button.

To create a heading for printed data

Note: The text you enter in this procedure will be part of the heading that will be shown on all printed data and data sent to LIS/HIS and AQUIRE/RADIANCE systems. The **Analyzer type:** will also be included.

1. Tap **Menu > Utilities > Setup > General setup > Analyzer settings > Analyzer ID**.
2. Enter the text for the heading (up to 25 characters). For example, a hospital or department name.
3. Tap the **Close** button.

To enable the screen saver

1. Tap **Menu > Utilities > Setup > General setup > Miscellaneous setup**.
2. Select the **Enable screen saver** check button.
3. In the **Screen saver** frame, select the number of minutes the analyzer must not be in use before the screen saver is shown.
4. Tap the **Close** button.

To set the time and date

This procedure sets the time and date on the analyzer clock. The time at which measurements and activities are done are read from this clock. If there is more than 2 hours

difference between the time you set and the system time, the activity is recorded in the **Activity log**.

1. Tap **Menu > Utilities > Setup > General setup > Analyzer settings > Time / Date**.
2. Enter the time.
Note: The **Current** button cancels entered values.
3. Enter the date.
Note: The **Current** button cancels entered values.
4. Tap the **Close** button.

To set the acoustic signals

1. Tap **Menu > Utilities > Setup > General setup > Analyzer settings > Acoustic signal**.
2. Select when you want an acoustic signal to be given.
3. Use the scroll buttons to select the volume level.
4. Tap the **Close** button.

To mute all acoustic signals

1. Tap **Menu > Utilities > Setup > General setup > Analyzer settings > Acoustic signal**.
2. Select the **Mute all acoustic signals** check button.
3. Tap the **Close** button.

To change the screen language

1. Tap **Menu > Utilities > Setup > General setup > Analyzer settings > Language**.
2. In the **Select a language from the list** frame, select a language.
3. Tap the **Set language** button.
4. Tap the **Continue** button.
5. Choose an option and follow the steps for it:

Option	Steps
To change the language immediately	Tap the Continue button. Note: This will restart the analyzer.
To change the language later. For example, if you also want to change regional settings.	a) Tap the Cancel button. b) Restart the analyzer later.

To select a regional setting

A regional setting includes default values for time and date formats, the separator used for thousands and decimals in numerical values and the layout of the keyboard shown on the analyzer screen.

1. Tap **Menu > Utilities > Setup > General setup > Analyzer settings > Language**.
2. In the **Regional settings** frame, select a regional setting.

3. Tap the **Set regional settings** button.
4. Tap the **Continue** button.

Note: This will restart the analyzer.

To set the barometric pressure

Prerequisite: The value of the barometric pressure in your laboratory.

This procedure makes sure that the analyzer barometer values are adjusted to the room in which the analyzer is used.

1. Tap **Menu > Utilities > Setup > General setup > Analyzer settings > Barometer**.
2. In the **Adjust to:** field, enter the value of the barometric pressure in your laboratory.
Note: The maximum difference between the **Measured unadjusted:** and **Adjust to:** values that the analyzer will accept is ± 19 mmHg.
3. Tap the **Close** button.

Related information

Environmental specifications, page 378

To log all measurement activities

By default not all measurement activities are recorded in the **Activity log**. This procedure sets up the analyzer to record all measurement activities.

1. Tap **Menu > Utilities > Setup > General setup > Miscellaneous setup**.
2. Select the **Log all measurement activities** check button.
3. Tap the **Close** button.

Analysis setup

Analysis modes

Syringe modes

Syringe modes refer to the types of analysis that can be done when the inlet is in the syringe position. The syringe mode, **Syringe - S 65 μ L** is setup by default for the analysis of patient samples in syringes. This mode can be edited and new syringe modes created.

Bilirubin can only be measured on neonatal samples. This parameter is only available in the Neonate blood analysis 65 μ L mode.

To edit a syringe mode

1. Tap **Menu > Utilities > Setup > Analysis setup > Syringe modes**.
2. Tap the button for the mode you want to edit in the **Primary modes** or **Secondary modes** field.

Note: The set of modes that holds the default mode is the one first shown during a measurement.

3. Tap the **Edit name** button.
4. If necessary, edit the name.
Note: The text – S 65µL cannot be changed.
5. Tap the **Parameters** button.
6. If necessary, choose another option and follow the steps for it.

Option	Steps
To set up a default parameter profile for the mode	Select the parameters to measure in the mode.
To let operators select the parameters they want to show in patient results	Select the Select parameter profile during measurement check button.
To set up a default parameter profile for the mode, but also let operators select the parameters they want to show in patient results	<ul style="list-style-type: none"> • Select the parameters to measure in the mode. • Select the Select parameter profile during measurement check button.

7. Make sure the check buttons for parameters you want to measure in this mode are selected.
8. Tap the **Back** button.
9. Tap the **Layout** button.
10. If necessary, select another patient report layout to be shown when you measure in this mode.
11. Tap the **Back** button.
12. Tap the button for the mode you want to be the default mode.
Note: The default mode is the mode the analyzer will use if no other measurement mode is selected.
13. Tap the **Close** button.

To create a new syringe mode

1. Tap **Menu > Utilities > Setup > Analysis setup > Syringe modes**.
2. Tap a button with no text in the **Primary modes** or **Secondary modes** field.
Note: The set of modes that holds the default mode is the one first shown during a measurement.
3. Select the **Button is enabled:** check button.
4. Tap the  button until the **Measuring program:** field shows the mode you want.
5. Tap the **Edit name** button.
6. Enter a name for the mode.
Note: The text – S 65µL cannot be changed.
7. Tap the **Parameters** button.

- Choose an option and follow the steps for it.

Option	Steps
To set up a default parameter profile for the mode	Select the parameters to measure in the mode.
To let operators select the parameters they want to show in patient results	Select the Select parameter profile during measurement check button.
To set up a default parameter profile for the mode, but also let operators select the parameters they want to show in patient results	<ul style="list-style-type: none"> • Select the parameters to measure in the mode. • Select the Select parameter profile during measurement check button.

- Make sure the check buttons for parameters you want to measure in this mode are selected.
- Tap the **Back** button.
- Tap the **Layout** button.
- If necessary, select another patient report layout to be shown when you measure in this mode.
- Tap the **Back** button.
- Tap the button for the mode you want to be the default mode.
A small black mark in the top right-hand corner of the button shows that the mode has been selected as the default.
Note: The default mode is the mode the analyzer will use if no other measurement mode is selected.
- Tap the **Close** button.

To remove a measurement mode

- Tap **Menu > Utilities > Setup > Analysis setup > Syringe modes**.
- Tap the button for the mode you want to remove.
- Deselect the **Button is enabled:** check button.
- Tap the **Close** button.

To select a default measurement mode

The default measurement mode is the mode the analyzer will use if no other measurement mode is selected.

- Tap **Menu > Utilities > Setup > Analysis setup > Syringe modes**.
- Tap the button for the mode you want to be the default mode.
A small black mark in the top right-hand corner of the button shows that the mode has been selected as the default.
- Tap the **Back > Close** buttons.

To select a specific patient report layout for an analysis mode

Prerequisite: There is more than one patient report layout.

This procedure lets you select the patient report layout that the analyzer shows during an analysis.

1. Choose an option and follow the steps for it.

Option	Steps
For analyses done with the inlet in the syringe position	Tap Menu > Utilities > Setup > Analysis setup > Syringe modes.
For analyses done with the inlet in the capillary position	Tap Menu > Utilities > Setup > Analysis setup > Capillary modes.

2. Tap the button for the mode in the **Primary modes** or **Secondary modes** field.
3. Make sure the **Button is enabled:** check button is selected.
4. Tap the **Layout** button.
5. Select the patient report layout to be automatically shown.
6. Tap the **Back > Close** buttons.

To set up a calibration-verification mode

It is necessary to set up a calibration-verification mode before calibration-verification measurements can be done.

1. Tap **Menu > Utilities > Setup > Analysis setup > Syringe modes.**
2. Tap a button with no text in the **Primary modes** or **Secondary modes** field.
3. Select the **Button is enabled:** check button.
4. Tap the  button until the button you selected in step 2 is given the name **Cal. Verification.**
5. Tap the button for the mode you want to be the default mode. A small black mark in the top right-hand corner of the button shows that the mode has been selected as the default.

Note: The default mode is the mode the analyzer will use if no other measurement mode is selected.
6. Tap the **Close** button.

To set up an ampoule QC mode

This is an optional procedure. It lets you start ampoule-based QC measurements from the same screen as you start patient sample analyses.

1. Tap **Menu > Utilities > Setup > Analysis setup > Syringe modes.**
2. Tap a button with no text in the **Primary modes** or **Secondary modes** field.
3. Select the **Button is enabled:** check button.
4. Tap the  button until the button you selected in step 2 is given the name **Ampoule - QC.**
5. Tap the button for the mode you want to be the default mode. A small black mark in the top right-hand corner of the button shows that the mode has been selected as the default.

Note: The default mode is the mode the analyzer will use if no other measurement mode is selected.
6. Tap the **Close** button.

Capillary modes

Capillary modes refer to the types of analysis that can be done when the inlet is in the capillary position.

The capillary mode **Capillary - C 65µL** is set up by default for the analysis of patient samples in capillary tubes. The mode can be edited.

To edit a capillary mode

1. Tap **Menu > Utilities > Setup > Analysis setup > Capillary modes**.
2. Tap the button for the mode you want to edit in the **Primary modes** or **Secondary modes** field.

Note: The set of modes that holds the default mode is the one first shown during a measurement.

3. Tap the **Edit name** button.
4. If necessary, edit the name.

Note: The text - C 65µL cannot be changed.

5. Tap the **Parameters** button.
6. If necessary, choose another option and follow the steps for it.

Option	Steps
To set up a default parameter profile for the mode	Select the parameters to measure in the mode.
To let operators select the parameters they want to show in patient results	Select the Select parameter profile during measurement check button.
To set up a default parameter profile for the mode, but also let operators select the parameters they want to show in patient results	<ul style="list-style-type: none"> • Select the parameters to measure in the mode. • Select the Select parameter profile during measurement check button.

7. Make sure the check buttons for parameters you want to measure in this mode are selected.
8. Tap the **Back** button.
9. Tap the **Layout** button.
10. If necessary, select another patient report layout to be shown when you measure in this mode.
11. Tap the **Back** button.
12. Tap the button for the mode you want to be the default mode.
A small black mark in the top right-hand corner of the button shows that the mode has been selected as the default.
Note: The default mode is the mode the analyzer will use if no other measurement mode is selected.
13. Tap the **Close** button.

Proficiency test modes

Proficiency test is a process that lets you verify the performance of your analyzer with accredited test solutions. Some local, state or federal regulations require proficiency tests to be done.

To get the proficiency test mode shown in the measuring screen, you have to set up a proficiency test mode.

To set up a proficiency test mode

It is necessary to set up a proficiency test mode before proficiency tests can be done.

1. Tap **Menu > Utilities > Setup > Analysis setup > Syringe modes**.
2. Tap a button with no text in the **Primary modes** or **Secondary modes** field.
3. Select the **Button is enabled**: check button.
4. Tap the  button until the button you selected in step 2 is given the name **Prof. Test**.
5. Tap the button for the mode you want to be the default mode.

Note: Make sure a small black mark is shown in the top right-hand corner of the button, as the mode is then set to be default.
6. Tap the **Close** button.
7. Tap **Menu > Utilities > Setup > Analysis setup > Syringe modes**.
8. Tap a button with no text in the **Primary modes** or **Secondary modes** field.
9. Select the **Button is enabled**: check button.
10. Tap the  button until the button you selected in step 2 is given the name **Prof. Test**.
11. Tap the button for the mode you want to be the default mode.

Note: Make sure a small black mark is shown in the top right-hand corner of the button, as the mode is then set to be default.
12. Tap the **Close** button.

Ranges and critical limits

About ranges and critical limits

Measurement results are marked by symbols to show where they fall in relation to reference ranges, critical limits and reportable ranges. The diagram illustrates these relationships.

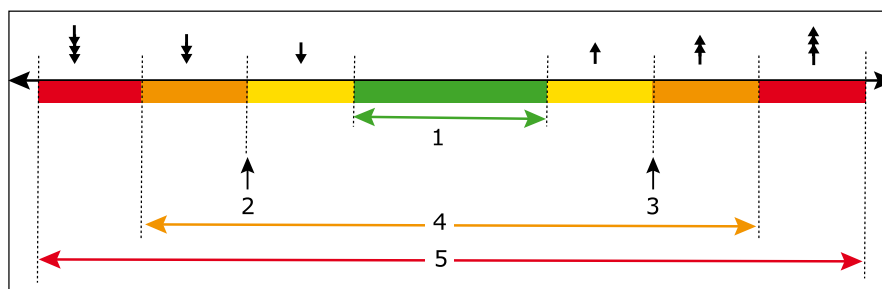

- | | |
|------------------------|-----------------------|
| 1 Reference range | 4 Reportable range |
| 2 Lower critical limit | 5 Range of indication |
| 3 Upper critical limit | |

The Range of indication is the range the analyzer is capable of measuring and includes values outside the Reportable range. The performance of the analyzer outside the Reportable range specified in the *Specifications* chapter has not been validated.

Only results within the Reportable range should be reported.

About reference ranges

A reference range is the range of test values expected for a healthy population of individuals or some other defined group. Patient results that lie outside the limits will be marked with the symbols:



Reference ranges are valuable guidelines for the clinician, but they should not be regarded as absolute indicators of health and disease. Reference ranges should be used with caution since values for 'healthy individuals often overlap significantly with values for persons afflicted with disease. In addition, laboratory values may vary significantly due to methodological differences and mode of standardization [1].

Reference ranges are not set up by default. Laboratories must establish their own ranges. If reference ranges are set up, patient results that lie outside the limits will be marked with symbols.

Related information

Symbols on patient results, page 28

Reference range of measured parameters

The Radiometer publication *Bulletin No: 44, Compendium of reference intervals* (product code 918-714) is available on request. Contact your local Radiometer representative. Other documents about reference ranges/intervals can be accessed on the www.acutecaretesting.org website.

Reference ranges for neonatal ctBil

Bilirubin can only be measured on neonatal samples. This parameter is only available in the Neonate blood analysis 65 µL mode.

Age	ctBil
≤24 hrs, premature	103-205 µmol/L 1.0-8.0 mg/dL 10-80 mg/L
≤24 hrs, full-term	34-103 µmol/L 2.0-6.0 mg/dL 20-60 mg/L
≤48 hrs, premature	103-205 µmol/L 6-12 mg/dL 60-120 mg/L
≤48 hrs, full-term	103-171 µmol/L 6-10 mg/dL 60-100 mg/L
3-5 days, premature	171-239 µmol/L 10-14 mg/dL 100-140 mg/L

3-5 days, full-term	68-137 µmol/L
	4-8 mg/dL
	40-80 mg/L

About critical limits

Critical limits are not set up by default. Laboratories must establish their own critical limits. If critical limits are set up, patient results that lie outside the limits will be marked with the symbols:



The symbols may be used to indicate when a value is dangerously high or low.

Related information

Symbols on patient results, page 28

To set the limits for patient age groups

This procedure is necessary if the reference ranges are not the same for all age groups.

Note: The age groups you set are for all parameters, they are not parameter-specific.

1. Tap **Menu > Utilities > Setup > Analysis setup > Reference ranges**.
2. Tap the **Age groups** button.
3. Use the left or right arrow buttons to select an age-limit field.
4. Select an age limit for the selected field.
5. Do steps 3 and 4 again to set the limits for each age group.

Note: The youngest age group always starts at zero years. The oldest age group always starts at the highest selected age limit. For example, if the highest selected age limit is 70 years, the oldest age group is from 70 to 70+ years.

6. Tap the **Back > Close** buttons.

To set up reference ranges and critical limits

Prerequisite: Patient age groups have been set

Laboratories should establish their own reference ranges.

1. Tap **Menu > Utilities > Setup > Analysis setup > Reference ranges**.
2. Select a parameter in the **Parameter:** field.
3. If the reference ranges of the selected parameter are dependent on a specific type of patient sample, select the **Sample type** check button.
4. If the reference ranges of the selected parameter are dependent on the age of patients, select the **Age group** check button.
5. If the reference ranges of the selected parameter are dependent on the sex of patients, select the **Sex** check button.
6. Select a setting for each of the buttons selected in steps 3, 4 and 5.
7. Tap the **Edit** button.
8. Enter values for the reference range and the critical limits.
If an entered value is not accepted, it will be removed and a message will be shown for a short period of time in a window on top of the screen.
9. Tap the **Back** button.
10. Do steps 6 to 9 again for each of the combinations of sample type, age and/or sex.

11. Do steps 2 to 10 again for each parameter.
12. Tap the **Close** button.

About reportable ranges

Reportable range is the range of results from a testing system or method over which analytical performance is claimed.

Patient results that lie outside the limits will be marked with the symbols:



Related information

- Ranges of indication and reportable ranges, page 371
- Symbols on patient results, page 28
- About range of indication, page 161

To set up reportable ranges

Note: Symbols are shown on test results that fall outside the reportable range of the measured parameter.

1. Tap **Menu > Utilities > Setup > Analysis setup > Reportable ranges**.
2. Choose an option and follow the steps for it.

Option	Steps
To set the reportable range of all parameters to the default values	<ol style="list-style-type: none"> a) Tap the Set all default button. b) Tap the Continue button.
To set the reportable range for a parameter to the default value	<ol style="list-style-type: none"> a) Select a parameter in the Parameters field. b) Tap the Set default button.
To set the reportable range for a parameter	<ol style="list-style-type: none"> a) Select the parameter in the Parameters field. b) Enter new values for the upper and lower limits of the reportable range.

3. Tap the **Close** button.

About range of indication

The Range of indication is the range the analyzer is capable of measuring and includes values outside the Reportable range. The performance of the analyzer outside the Reportable range specified in the *Specifications* chapter has not been validated.

Only results within the Reportable range should be reported

Sample pre-registration

About sample pre-registration

Sample pre-registration lets operators make sure that the patient data shown on the screen belongs to the patient whose sample is to be analyzed. This reduces the risk of patient/sample mix-up.

Note: The analyzer must be set up for sample pre-registration.

Related information

To set up sample pre-registration, page 162

To set up sample pre-registration

1. Tap **Menu > Utilities > Setup > Analysis setup > Sample pre-registration**.
2. Select a value in the **Interpret barcode input as** field.
3. Make sure that check buttons are selected for the data fields you want included in the **Patient identification** screen shown during pre-registration.

Note: A data field is automatically included for the value you selected in step 2.

4. Tap the **Close** button.

Sample age evaluation

About sample age evaluation

Sample age evaluation lets the analyzer calculate the age of patient samples and compare it to the value set in the **Sample age rule in minutes** value. Samples older than this value will be analyzed but a message attached to the patient result will indicate that the sample was old.

The calculation is based on the sample **Draw time** entered on the **Patient identification** screen:

[Sample age] = [Time the sample aspiration starts] - [Time the sample was collected].

Maximum sample age

Maximum sample age is the maximum period of time that should elapse between when a sample is collected and when it is analyzed. How the sample is stored and handled after it is collected has an effect on the maximum sample age.

Note: Maximum sample age is not the same as the **Max sample age**.

Related information

Storage recommendations, page 19

To set a maximum sample age

The **Sample age rule in minutes** value is set by default to the same value for all parameters. However, a value can be set for each individual parameter.

Note: You must include the **Sample age** item in your patient report layouts to see calculated values.

1. Tap **Menu > Utilities > Setup > Analysis setup > Sample age evaluation setup**.
2. Select the **Enable sample age evaluation** check button.

3. Choose an option and follow the steps for it.

Option	Steps
To select the same maximum sample age for all parameters	<ul style="list-style-type: none"> • Select a maximum sample age for the parameter in the Sample age rule in minutes field. • Select the Same rule for all the parameters check button.
To select a maximum sample age for a parameter	<ul style="list-style-type: none"> • Select a parameter. • Select a maximum sample age for the parameter in the Sample age rule in minutes field.

4. Tap the **Close** button.

Max sample age

Max sample age is a read-only field in the Patient identification screen. The value shown in the field is the value entered by the RADIANCE system, which overwrites the **Sample age rule in minutes** value set up on the analyzer.

Patient report layouts

About patient report layouts

A patient report layout has 2 parts:

- A patient ID part – lets you create the content and layout of the **Patient identification** screen
- A patient results part – lets you create a template for the content and layout of the **Patient results** screen

You can select a default patient report layout. The default report layout is the **Report layout** shown in the **Patient identification** screen when it opens.

To create a patient report layout

1. Tap **Menu > Utilities > Setup > Analysis setup > Patient reports**.
2. Tap the **New** button.
3. Enter a name for the report in the **Name:** field.
4. Tap the **Edit patient ID layout** button.
5. To add data items to the layout:
 - a) Select a data item in the **Available items** frame.
 - b) Tap the right arrow button.

Note: Data items are shown in the layout as you add them.

 - c) Do steps a) and b) again for each data item you want to add.

Option	Steps
If patient data is to be automatically requested from a LIS/HIS or AQUIRE/RADIANCE system	Add the data item that was selected in the Interpret barcode input as field during the sample pre-registration setup procedure.

Option	Steps
If patient data is to be manually requested from a LIS/HIS or AQUIRE/RADIANCE system	<p>Add the data field selected in the Request patient demographics frame during the automatic requests for patient data procedure.</p> <p>It will be one of the items: Sampler ID, Patient ID or Accession no.</p> <p>Note: If more than one of these items are added, it is the item closest to the top of the Patient identification screen that must be filled before you can manually request patient data from the LIS/HIS or AQUIRE/RADIANCE system.</p>
If patient data is to be looked up, found and requested manually	Add the "Department (Pat.);" data item.
If the analyzer is connected to a RADIANCE system.	<p>Add the Max sample age item.</p> <p>The value shown in this field will show the value set in the RADIANCE system.</p>

6. To make a data item mandatory:
 - a) Select the data item in the **Selected items** frame.
 - b) Tap the **Set as mandatory** button.

Note: The mandatory icon is shown adjacent to the data item. 
7. To set a default value for a data item, choose an option and follow the steps for it.

Option	Steps
To enter a value	<ol style="list-style-type: none"> a) Select the data item in the Selected items frame. b) Tap the Keyboard button. c) Enter a value.
To select a value from a data item list	<ol style="list-style-type: none"> a) Select the data item in the Selected items frame. b) Tap the List button. c) Select a value in the Available values field. d) Tap the Select button.

8. Tap the **Back** button.
9. Tap the **Edit patient results layout** button.
10. To add a heading for a group of parameters:
 - a) In the **Available items** frame, select a heading. For example, "Blood gas values".
 - b) Tap the right arrow button.
11. To add a parameter:
 - a) In the **Available items** frame, select a parameter.
 - b) Tap the right arrow button.

Note: Parameters will be shown in the results as they are shown in the **Selected items** field.

 - c) If necessary, do steps a) and b) again.
12. To change the position of an item in the **Selected items** frame:
 - a) Select the item.
 - b) Tap the left arrow button.
 - c) In the **Selected items** frame, select the item you want the selected item to follow.
In the **Available items** frame, select the item you selected in step a).
 - d) Tap the right arrow button.

13. To show the reference range of a parameter with patient results:
 - a) In the **Selected items** frame, select a parameter.
 - b) Tap the **Show ranges** button.
 - c) If necessary, do steps a) and b) again for other parameters.
14. To change the selected data items to the data items in the Radiometer default report layout, tap the **-R- Default** button.
15. Tap the **Back > Close** buttons.

Related information

To select a patient report layout as default, page 166

To change a patient result layout

This procedure tells you how to change the patient result layout for a selected layout.

1. Tap **Menu > Utilities > Setup > Analysis setup > Patient reports**.
2. Select the layout.
3. Tap the **Edit patient results layout** button.
4. To add a heading for a group of parameters:
 - a) In the **Available items** frame, select a heading. For example, "Blood gas values".
 - b) Tap the right arrow button.
5. To add a parameter:
 - a) In the **Available items** frame, select a parameter.
 - b) Tap the right arrow button.

Note: Parameters will be shown in the results as they are shown in the **Selected items** field.
 - c) If necessary, do steps a) and b) again.
6. To change the position of an item in the **Selected items** frame:
 - a) Select the item.
 - b) Tap the left arrow button.
 - c) In the **Selected items** frame, select the item you want the selected item to follow.
 - d) Tap the right arrow button.
7. To show the reference range of a parameter with patient results:
 - a) In the **Selected items** frame, select a parameter.
 - b) Tap the **Show ranges** button.
 - c) If necessary, do steps a) and b) again for other parameters.
8. Tap the **Back > Close** buttons.

To create extra items for use in patient report layouts

1. Tap **Menu > Utilities > Setup > General setup > Parameters and input > User-defined data items**.
2. Choose an option and follow the steps for it.

Option	Steps
To create a text item.	<ol style="list-style-type: none"> a) Tap the Add button. b) Enter the name of the item. Note: Only enter 20 characters, so that the complete name is seen in the Patient Identification screen. c) Select "Text" in the field on the right of the screen. d) Tap the Select button. e) Tap the Back button.
To create a numerical item.	<ol style="list-style-type: none"> a) Tap the Add button. b) Enter the name of the item. Note: Only enter 20 characters, so that the complete name is seen in the Patient Identification screen. c) Select "Numerical" in the field on the right of the screen. d) Tap the Select button. e) Enter the name of the unit. f) If entered numbers must have a fixed number of decimals to be accepted, select the number of decimals. Tap the Select button. g) If entered numbers must fall within a range to be accepted, enter the maximum and minimum values of the range. h) Tap the Back button.
To create a selection list for an existing text or numerical item. Note: A minimum of 2 values must be added to create a list.	<ol style="list-style-type: none"> a) Select the item. b) Tap the Edit button. c) Tap the Use selection list check button. d) Tap the Add button. e) Enter a value. f) Do steps d) to e) again for each item you want in the selection list. g) Tap the Use selection list check button. h) Tap the Back button.

3. Tap the **Close** buttons.

To select a patient report layout as default

The patient report layout you select as default is the one shown in the **Patient identification** screen when it opens.

1. Tap **Menu > Utilities > Setup > Analysis setup > Patient reports**.
2. Select the layout.
3. Tap the **Make default** button.
4. Tap the **Close** button.

To automatically change the temperature units

The analyzer can be set up to let temperatures (for example, patient temperatures) be entered in Celcius (°C) or Fahrenheit (°F) degrees. However, this procedure lets the analyzer automatically change the set up temperature unit from °F to °C if an operator enters °C values in a °F temperature field and vice versa.

Examples: If 41 is entered as the patient temperature in a °F temperature field, the analyzer will automatically change the unit to °C. If 105 is entered as the patient temperature in a °C temperature field, the analyzer will automatically change the unit to °F.

1. Tap **Menu > Utilities > Setup > General setup > Miscellaneous setup**.
2. Select the **Auto temp unit conversion** check button.
3. Tap the **Close** button.

To edit a patient report layout

1. Tap **Menu > Utilities > Setup > Analysis setup > Patient reports**.
2. Select the layout.
3. Tap the **Edit patient ID layout** button.
4. To add an item to the layout:
 - a) Select an item In the **Available items** frame.
 - b) Tap the right arrow button.

Note: Items are shown in the layout as you add them.
5. To remove an item from the layout:
 - a) Select an item In the **Selected items** frame.
 - b) Tap the left arrow button.
6. To make an item mandatory:
 - a) Select the item in the **Selected items** frame.
 - b) Tap the **Set as mandatory** button.
7. To set a default value for an item:
 - a) Select the item in the **Selected items** frame.
 - b) Tap the **Keyboard** button and enter a value, or: (1) Tap the **List** button. (2) Select a value. (3) Tap the **Select** button.
8. Tap the **Back** button.
9. Tap the **Edit patient results layout** button.
10. To add a heading for a group of parameters:
 - a) In the **Available items** frame, select a heading. For example, "Blood gas values".
 - b) Tap the right arrow button.
11. To add a parameter:
 - a) In the **Available items** frame, select a parameter.
 - b) Tap the right arrow button.

Note: Parameters will be shown in the results as they are shown in the **Selected items** field.
 - c) If necessary, do steps a) and b) again.
12. To change the position of an item in the **Selected items** frame:
 - a) Select the item.
 - b) Tap the left arrow button.
 - c) In the **Selected items** frame, select the item you want the selected item to follow.

In the **Available items** frame, select the item you selected in step a).
 - d) Tap the right arrow button.

13. To show the reference range of a parameter with patient results:
 - a) In the **Selected items** frame, select a parameter.
 - b) Tap the **Show ranges** button.
 - c) If necessary, do steps a) and b) again for other parameters.
14. Tap the **Back** button.
15. If necessary, enter a new name for the report in the **Name:** field.
16. To change the selected data items to the data items in the Radiometer default report layout, tap the **-R- Default** button.
17. Tap the **Close** button.

To create a patient report layout for $FShunt$ and $ctO_2(a-\bar{v})$

1. Tap **Menu > Utilities > Setup > Analysis setup > Patient reports**.
2. Select the **-R- Default** layout.
3. Tap the **Copy** button.
4. Enter a name for the report in the **Name:** field.
5. Tap the **Edit patient ID layout** button.
6. Select $pO_2(\bar{v})$ in the **Available items** frame.
7. Tap the right arrow button.
8. Do steps 5 and 6 again for these parameters:
 - $sO_2(\bar{v})$
 - $FO_2(I)$
 - RQ
 - T
9. If necessary, select another patient identifier in the **Available items** frame.
10. Tap the right arrow button.
11. Do steps 8 and 9 again for each data item you want to add.
12. Tap the **Back** button.
13. Tap the **Edit patient results layout** button.
14. Select $FShunt$ in the **Available items** frame.
15. Tap the right arrow button.
16. Select $ctO_2(a-\bar{v})$ in the **Available items** frame.
17. Tap the right arrow button.
18. Tap the **Back > Close** buttons.

Patient result settings

To set up automatic printing of acid-base charts

This procedure lets you set up the analyzer to automatically print acid-base charts when a selected report layout is used during a measurement.

1. Tap **Menu > Utilities > Setup > Analysis setup > Patient reports**.
2. Select a report layout.
3. Select the **Print Acid-Base chart** check button.

Note: Acid-base charts are only printed when all necessary parameter values are available.
4. Tap the **Close** button.

Approval and rejection of patient results

Approval/rejection of patient results is not set up by default. If it is set up, it can be used to filter patient results that are transmitted to a LIS/HIS system. Approved results are transmitted, rejected results are not.

Note: An approved patient result does not indicate that the result can be used in a clinical evaluation of the patient.

Approval can for example be used to make sure that necessary data was correctly entered, for example, that the **Sample type** was "Venous", not "Arterial" and the patient temperature was 42 °C, not 38 °C.

Note: Approved/rejected results cannot be edited.

To enable patient result approval/rejection

1. Tap **Menu > Utilities > Setup > General setup > Miscellaneous setup**.
2. Select the **Enable patient result approval** check button.
3. Tap the **Close** button.

Parameter settings

To show the parameter bar

1. Tap **Menu > Utilities > Setup > General setup > Miscellaneous setup**.
2. Select the **Show parameter bar** check button.
3. Tap the **Close** button.

To hide the parameter bar

1. Tap **Menu > Utilities > Setup > General setup > Miscellaneous setup**.
2. Deselect the **Show parameter bar** check button.
3. Tap the **Close** button.

To enable/disable a parameter

When you disable a parameter, it will not be shown in the parameter bar. You cannot measure the parameter, it will not be calibrated and no built-in QC measurements will be done for it.

Note: You cannot disable the pH, pO_2 or pCO_2 parameters .

1. Tap **Menu > Utilities > Setup > General setup > Parameters and input > Parameters**.
2. Select the parameter.
3. Tap the **Enable/ Disable** button.

Note: The first value in the **Enabled/locked** column must be "Yes" to enable the parameter, and "No" to disable it.

4. Tap the **Close** button.

To set up measuring units for parameters

1. Tap **Menu > Utilities > Setup > General setup > Parameters and input > Units**.
2. Use the scroll buttons to select the field adjacent to the parameter.
3. In the **Possible units** frame, select the unit.
4. Tap the **Close** button.

To repress a parameter

When you repress a parameter, no value will be given for the parameter in patient results if an error occurred during the measurement.

If an QC or calibration problem exists repressing a parameter will change the parameter tab to red and repress that parameter in subsequent patient results.

1. Tap **Menu > Utilities > Setup > General setup > Parameters and input > Parameters**.
2. Select the parameter.
3. Tap the **Edit** button.
4. Select the **Repress parameter value in patient result in case of any problems** check button.
5. Tap the **Back > Close** buttons.

To suppress out-of-range results

Only out-of-range oximetry parameters can be suppressed.

- Suppression causes oximetry results (excluding ctHb) that are within the range of indication* and below zero to be shown as zero, and results that are within the range of indication* and above 100 % to be shown as 100 %.
- Suppression of ctHb or ctBil** results that are within the range of indication* but below zero will be shown as zero.

1. Tap **Menu > Utilities > Setup > General setup > Parameters and input > Parameters**.
2. Select the parameter.
3. Tap the **Edit** button.
4. Select the **Out of range suppression** check button.
5. Tap the **Back > Close** buttons.

* The Range of indication is the range the analyzer is capable of measuring and includes values outside the Reportable range. The performance of the analyzer outside the Reportable range specified in the *Specifications* chapter has not been validated. Only results within the Reportable range should be reported.

** Bilirubin can only be measured on neonatal samples. This parameter is only available in the Neonate blood analysis 65 μ L mode.

To fix the number of decimals used in blood-gas results

The analyzer measures the blood gas parameters pO_2 and pCO_2 more precisely in the lower part than in the upper part of ranges. By default, results are shown with a different number of decimal points. For example, in the range 0-99.9 mmHg, $pO_2(T)$ results are shown with one decimal point and in the range 100-750 mmHg, with no decimal points (that is, in whole numbers).

This procedure can be used to make sure pO_2 and pCO_2 results are shown with the same number of decimal points in the whole reportable range.

1. Tap **Menu > Utilities > Setup > General setup > Miscellaneous setup**.
2. Select the **Fixed pO_2/pCO_2 decimals** check button.
3. Tap the **Close** button.

Related information

Measurement precision within specified ranges, page 372

To enable HbF corrections

Prerequisite: You know if the analyzer is to be used to analyze neonatal samples only, adult samples only, neonatal samples and adult samples or samples that contain hemoglobins that deviate from HbA hemoglobins.

This procedure is necessary to make sure that ctBil*, sO_2 , FO_2Hb , $FMetHb$, $FCOHB$ and $FHHb$ results are corrected for the presence of HbF in the sample.

1. Tap **Menu > Utilities > Setup > General setup > Miscellaneous setup**.
2. In the **HbF correction** frame, choose an option and follow the steps for it.

Option	Steps
For neonatal samples	Select "Enabled for all levels"
For adult samples	Select "Enabled for levels > 20 %"
For neonatal and adult samples	Select "Enabled for levels > 20 %"
For adult samples that contain hemoglobins which deviate from HbA hemoglobins	Select "Disabled"

Note: The "Enabled for all levels" setting will correct ctBil*, sO_2 , FO_2Hb , $FMetHb$, $FCOHB$ and $FHHb$ results and show HbF values.

3. Tap the **Close** button.

* Bilirubin can only be measured on neonatal samples. This parameter is only available in the Neonate blood analysis 65 μ L mode.

Related information

Restrictions, page 368

To enable the estimation of derived parameters

This procedure lets the analyzer replace missing measured values and/or keyed-in values with default values in order to estimate values for derived parameters. Estimated results are marked with the subscript e.

1. Tap **Menu > Utilities > General setup > Miscellaneous setup**.
2. Select the **Enable estimated derived parameters** check button.
3. Tap the **Close** button.

Related information

Derived parameters, page 314

Editing the slope and offset of a parameter

Operator-defined corrections (offset and slope)

Operator-defined corrections refer to corrections made to the offset and/or slope of parameters.

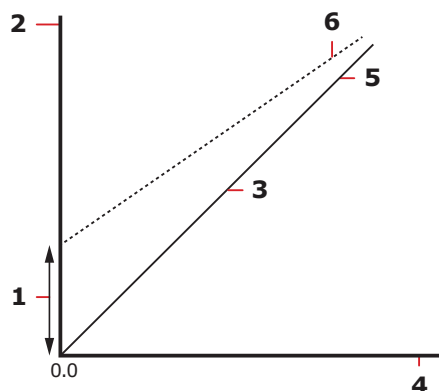

- | | |
|--------------------------------|---|
| 1 Offset | 4 Measured values (x axis) |
| 2 Shown values (y axis) | 5 Correction line without operator-defined corrections |
| 3 Slope = 1.0 | 6 Correction line with operator-defined corrections |

The diagram shows the relation between correction lines with and without operator-defined corrections.

operator-defined corrections are most commonly applied when the values measured for a parameter by two or more analyzers deviate consistently from each other.

operator-defined corrections are based on a linear correlation between the measured values (without operator-defined corrections) and the shown values (with operator-defined corrections).

The correction factors for each measured parameter are the slope and the offset of the correction line. With operator-defined corrections it is possible to change the values of the slope and offset or only change the value of one of them. This depends on the parameter.

$$\text{Corrected value} = \text{Slope} \times \text{Uncorrected value} + \text{Offset}$$

Before you enter corrections for a parameter, you must have the reference value for the parameter. Use a procedure accepted in your laboratory to get the reference value.

Here are the other prerequisites:

- Analyses must be done on the analyzer without the use of operator-defined corrections and on one reference analyzer
- Analyses must be done over the full measuring range
- Analyses must be done on the analyzer and on the reference analyzer at the same time, and the samples must be handled correctly
- The slope and the offset must be calculated. You may, for example, make a linear correlation between the values measured on the analyzer and the reference analyzer. The analyzer is then used as an independent variable.
- You must verify the corrections entered.

Recommendations about samples to use

Parameter	Sample description
ctHb	Use a SAT100 sample to approximately 15 g/dL (9.3 mmol/L) (which is the maximum uncorrected or corrected point) and pH is approximately 7.4
sO ₂	Set ctHb of gas equilibrated SAT0 and SAT100 sample to approximately 15 g/dL (9.3 mmol/L) and pH is approximately 7.4
FCOHb	The zero point (FCOHb approximately zero) is saturated to approximately SAT100, and ctHb is set to approximately 15 g/dL (9.3 mmol/L) and pH is approximately 7.4
FMetHb	The zero point (FCOHb approximately zero) is saturated to approximately SAT100, and ctHb is set to approximately 15 g/dL (9.3 mmol/L) and pH is approximately 7.4
FHbF	Radiometer recommends that the ctHb in adult samples (with FHbF = 0) and fetal samples (with high FHbF) is set to approximately 15 g/dL (9.3 mmol/L), sO ₂ is approximately 100 % and pH is approximately 7.4
ctBil*	Radiometer recommends that human plasma or serum is used with pH = 7.4 (the analyzer reading). Zero point sample could be adult sample (ctBil*)

* Bilirubin can only be measured on neonatal samples. This parameter is only available in the Neonate blood analysis 65 µL mode.

Limits for slope and offset values

The slope and offset value of some parameters can be changed to values that fall within the limits stated in the tables.

- For arterial, venous and a- \bar{v} samples:

Limits for pH and blood gases		
Parameter	Limits for the slope value	Limits for the offset value
pH	0.95-1.05 (pH unit)	±0.1 (pH unit)
pCO ₂	0.95-1.05 kPa	±0.5 kPa
pO ₂	0.95-1.05 kPa	±0.5 kPa

Limits for electrolyte parameters		
Parameter	Limits for the slope value (mmol/L)	Limits for the offset value (mmol/L)
cK ⁺	0.75-1.25	±0.3
cNa ⁺	0.85-1.15	±5
cCa ²⁺	0.8-1.2	±0.05
cCl ⁻	0.85-1.15	±5

Limits for metabolite parameters		
Parameter	Limits for the slope value (mmol/L)	Limits for the offset value (mmol/L)
cGlu	0.75-1.25	±0.5

Limits for metabolite parameters		
Parameter	Limits for the slope value (mmol/L)	Limits for the offset value (mmol/L)
cLac	0.75-1.25	±0.5

Limits for oximetry parameters		
Parameter	Limits for the slope value	Limits for the offset value
ctHb	0.95-1.05 mmol/L	±2 mmol/L
sO ₂	0.9-1.1 (fraction)	±0.05 (fraction)
FCOHb	Cannot be changed	±0.05 (fraction)
FMetHb	Cannot be changed	±0.05 (fraction)
FO ₂ Hb	Cannot be changed	If measurements indicate that it is necessary to change the offset value for sO ₂ and/or FCOHb and/or FMetHb, change it. Use the equation: $sO_2 \times (1 - FCOHb - FMetHb)$ to calculate FO ₂ Hb concentrations.
FHHb	Cannot be changed	If measurements indicate that it is necessary to change the offset value for sO ₂ and/or FCOHb and/or FMetHb, change it. Use the equation: $(1 - sO_2) \times (1 - FCOHb - FMetHb)$ to calculate FHHb concentrations.
FHbF	0.8-1.2 (fraction)	±0.2 (fraction)
	Note: Before samples are analyzed, "Enabled for all levels" must be selected for HbF correction in the Miscellaneous setup screen.	
ctBil*	0.5-1.5 (µmol/L)	±100 (µmol/L)

* Bilirubin can only be measured on neonatal samples. This parameter is only available in the Neonate blood analysis 65 µL mode.

Related information

To enable HbF corrections, page 171

To edit the offset and slope for a parameter

⚠ WARNING – Risk of incorrect measurement results

Changes made to the offset and/or slope of parameters will have an effect on patient results and change some performance characteristics. If you do not want the changes to have an effect on QC results, too, make sure the **Apply parameter corrections to QC** check button is deselected in the **Miscellaneous setup** screen.

1. Tap **Menu > Utilities > Setup > General setup > Parameters and input > Parameters**.
2. Select the parameter.
3. Tap the **Edit** button.
4. If necessary, enter a new value for **Correction offset**.

5. If necessary, enter a new value for **Correction slope**.
6. Tap the **Back > Close** buttons.

Calibration settings

Details about calibration frequency

By default the analyzer is set up to do automatic calibrations and built-in QC measurements at intervals that enable optimum use to be made of materials in the Solution Pack. The table provides details.

Note: Automatic calibrations are also done when the Sensor Cassette or Solution Pack are replaced, in connection with maintenance and troubleshooting procedures and when the analyzer is restarted.

Calibration identifier (parameters)	Calibration	Calibration material	Default frequency	Default start time
Elec, pH (cK ⁺ , cNa ⁺ , cCa ²⁺ , cCl ⁻ , pH)	Sensitivity	CAL 1 solution CAL 2 solution	Once a day	08:00 hours
	Status	CAL 1 solution	Every measurement	N/A
BG, Met (pCO ₂ , cGlu, cLac)	Sensitivity	CAL 1 solution CAL 3 solution	Every 4 hours	02:00 hours
	Status	CAL 1 solution	Every measurement	N/A
BG (pO ₂)	Sensitivity	CAL 1 solution Ambient air	Once a day	16:00 hours
	Status	CAL 1 solution	Every measurement	N/A
Oxi (Oximetry parameters)	Sensitivity	CAL 1 solution ctHb calibration solution (S7770)	Every 3 months (recommended)	N/A
	Status	CAL 3 solution	<ul style="list-style-type: none"> • Every 4 hours • When temperature drift in the oximetry optical system is outside specified limits 	N/A

Note: The calibration identifier **BG, Met**, **Oxi** and **BG, Elec, Met, pH** are combinations of those listed in the table.

Related information

Calibration frequency after a Sensor Cassette replacement, page 40

To edit the calibration schedule

Note: Changes made to the default schedule may prevent optimum use of solutions in the Solution Pack. This is because the automatic calibrations and built-in QC measurements are scheduled by default to be done at times that let the analyzer make optimum use of the calibration and QC materials in the Solution Pack.

This procedure lets you change the default schedule for calibrations, (automatic calibrations) and tHb calibrations (sensitivity calibration of oximetry parameters, which is a manual calibration).

1. Tap **Menu > Utilities > Setup > Calibration schedule.**
2. Choose an option and follow the steps for it.

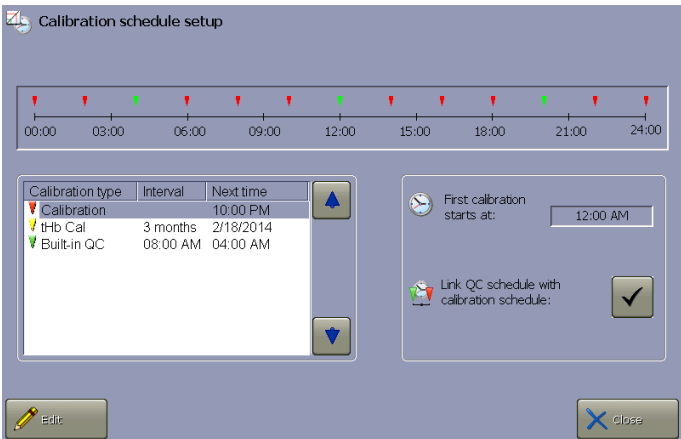
Option	Steps
To change the start time for automatic calibrations	<ul style="list-style-type: none"> • Select "Calibration" as the Calibration type. • Tap the Edit button. • Select a new Start time.  <p>Note: The schedule above shows both the default calibration schedule as well as the default start time for a number of specific system checks that are scheduled to start at 00:00 (24:00) hours. The change you make to the start time in this step will change the start time for both automatic calibrations and other system checks. For example, if the start time is changed from 00:00 to 02:00 hours, automatic calibrations will be delayed by 2 hours.</p>
To change the start time for the next sensitivity calibration of tHb	<ul style="list-style-type: none"> • Select "tHb Cal" as the Calibration type. • Tap the Edit button. • Select a Start time. • Select an Interval setting. <p>Note: The day the next calibration is scheduled = [current date] + [Interval setting].</p>

To link the built-in QC schedule to the calibration schedule

This procedure changes the current schedule for built-in QC measurements to the default schedule. This lets the analyzer make optimum use of the solutions in the Solution Pack.

1. Tap **Menu > Utilities > Setup > Calibration schedule.**
2. Select "Calibration" in the **Calibration type** field.
3. Select the **Link QC schedule with calibration schedule** check button.
4. Tap the **Close** button.

To set up corrective actions for overdue scheduled calibrations

This procedure lets you select what the analyzer must do when scheduled calibrations are overdue.

1. Tap **Menu > Utilities > Setup > General setup > Corrective actions**.
2. Select "Calibration schedule reminder(s)".
3. Choose an option and follow the steps for it.

Option	Steps
To select the color of the traffic light signal on the Analyzer status button	Tap the Traffic light signal check button until it shows the color you want
To attach a message about the overdue scheduled calibration to patient results	Make sure the check button in the Corrective action(s) frame is selected

4. Tap the **Close** button.

Quality control

Glossary of quality control terms

Term	Explanation
Accepted result	A QC result that falls within the statistical range
Assigned value	The assigned value is the center value of a control range. Note: For Radiometer quality control solutions used for ampoule-based QC measurements, control ranges are given in the insert.
Control range	The range within which a QC result should fall. The control range is calculated to be the mean value ± 2 SD. Note: This range can be set to the lot-to-date range (2 SD) calculated by the analyzer.
Insert range	The upper and lower limits of a control range established for a Radiometer quality control solution. The ranges are calculated from the results of 30-50 QC measurements done on each of 10 analyzers. Measurements are done 2-5 times a day over a period of 1-4 weeks.
Lot-to-date range	A range calculated by the analyzer based on a minimum number of measurements done with a specific lot of a quality control solution. It is the mean value ± 2 SD.
Statistical factor	The factor which a control range is multiplied by to determine the statistical range. The recommended statistical factor is 1.5.
Statistical range	The range within which a QC result must fall in order to be included in the QC statistics. It is determined by multiplying the control range limits by the statistical factor. When the recommended statistical factor of 1.5 is used, the statistical range will be the mean ± 3 SD.

Registration of QC solutions

Why is it necessary to register QC solutions?

When a QC solution is registered, data about the solution is saved on the analyzer. The data is necessary to evaluate QC results. For example, to make sure that the result falls within the specified control range and mark the results that do not. It is only necessary to register a specific lot of a QC solution one time.

About registration of QC solutions

QC measurement type	About registration of the QC solutions used
Built-in QC measurements	The QC solutions are automatically registered when the Solution Pack is installed. A chip on the Solution Pack supplies data about the solutions.
Ampoule-based QC measurements	Each lot of each level of QC solution must be manually registered before use. This applies to Radiometer and non-Radiometer QC solutions. The ABL90 FLEX barcode on the product insert for each level of Radiometer QC solution supplies data about it. The data is saved on the analyzer and used when ampoule-based QC measurements are done with the solution.

To register a Radiometer QC solution for ampoule-based QC measurements

Prerequisite: The product insert (the document supplied with the QC solution).

You must register each level of each lot of QC solution before you can use them.

1. Tap **Menu > Utilities > Setup > QC setup > QC solutions**.
2.  **WARNING – Risk of data loss**
Select a **Slot** that contains no data. If you select a slot that contains data, all statistical data related to the QC solution registered in the slot will be irreversibly deleted.
Note: The number of the slot can be thought of as a registration number.
3. Scan or enter the barcode for the ABL90 FLEX analyzer from the product insert.
4. Tap the **Close** button.

Post-requisite: If local, state or federal regulations require it, establish analyzer-specific control ranges.

Data saved during registration of Radiometer QC solutions

During registration the barcode for the ABL90 FLEX analyzer is scanned from the product insert. The screen shows the data that is read from the barcode and saved on the analyzer.

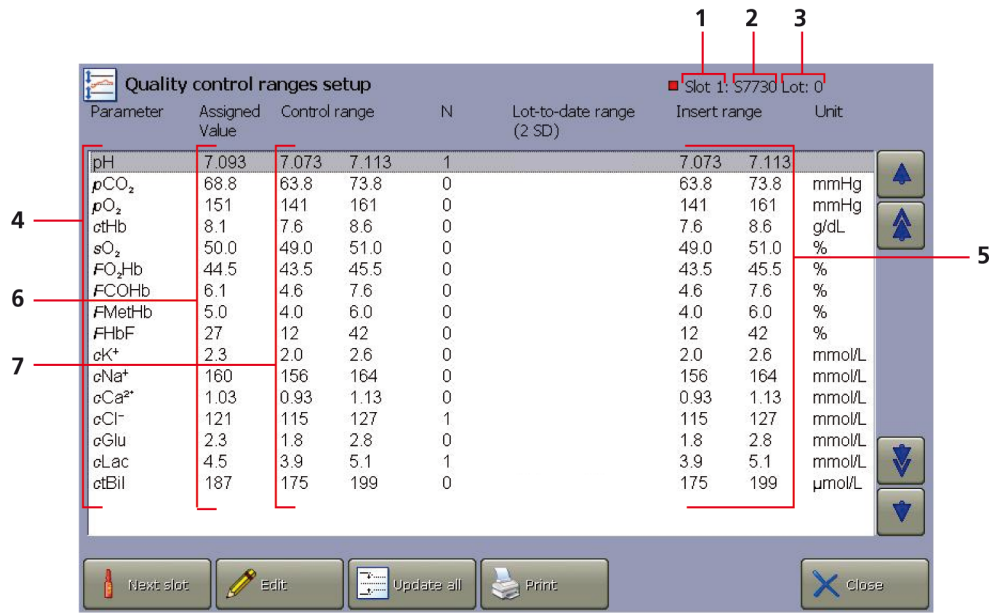

- 1 Slot 1** – The slot number tells the analyzer where data for the specific lot of the QC solution is stored
 - 2** The generic name of the QC solution – The character S followed by a four digit number. For example, S7750.
 - 3 Lot:** – The lot number of the QC solution
 - 4 Parameter** – The parameters that can be measured
 - 5 Insert range** – The control range given on the product insert for the analyzer
 - 6 Assigned Value** – The center value of the **Insert range**
 - 7 Control range** – By default, the control range is given the same values as the **Insert range**.
- Note:** If local, state or federal regulations require it, control ranges can be changed to analyzer-specific control ranges established by your laboratory.

Related information

How to establish analyzer-specific control ranges, page 191

To register a non-Radiometer QC solution

Prerequisite: Control ranges for the parameters to be measured with the QC solution.

Note: If non-Radiometer QC solutions are used, Radiometer cannot guarantee accurate, valid QC results.

Note: Results of QC measurements done with non-Radiometer QC solutions are not automatically temperature corrected.

1. Tap **Menu > Utilities > Setup > QC setup > QC solutions**.
2. Select a **Slot** that contains no data.
 - Note:** The number of the slot can be thought of as a registration number.
3. Tap the **Add non-R-** button.

4. Write down the number of the **Slot**. The number is necessary in step 7 of this procedure.
5. Tap the **Close** button.
6. Tap **Menu > Utilities > Setup > QC setup > QC ranges**.
7. Tap the **Next slot** button to select the number of the slot you wrote down in step 4.
8. Tap the **Edit** button.
9. Enter values for the **Current control range** of the parameter shown on the screen.
10. Tap the **Next param.** button to select the next parameter.
11. Enter values for the **Current control range** of the parameter shown on the screen.
12. Do steps 10 and 11 again for all parameters.
13. Tap the **Back > Close** buttons.

Data saved during registration of non-Radiometer QC solutions

Here is the data that can be saved during registration of a non-Radiometer QC solution:

- Generic name Non-R-
- **Control range** for each parameter

Quality control solutions

To set up the temperature field for QC measurements

Note: QC results are temperature dependent. That is why there is a **Temperature** field in the **Quality control identification** screen that is shown during ampoule-based QC measurements.

This procedure lets you make it mandatory to enter the room temperature in **Temperature** field, or set a default value in the field.

Note: If necessary, a set default temperature can be changed during an ampoule-based QC measurement.

1. Tap **Menu > Utilities > Setup > QC setup > QC input setup**.
2. Choose an option and follow the steps for it.

Option	Steps
To make the Temperature field mandatory. Note: When this option is chosen, operators must enter the room temperature before QC results are shown.	Select the Mandatory temperature: check button.
To set a default temperature	Enter a temperature in the Default temperature: field.

3. Tap the **Close** button.

Scheduled QC measurements

To schedule ampoule-based QC measurements

Prerequisite: The QC solution is registered.

1. Tap **Menu > Utilities > Setup > QC setup > QC schedule**.
2. Tap the **Add** button.
3. Select the registered QC solution, on the right of the screen.
4. Tap the **Select** button.
5. Enter a start time.
6. Select a value for the **Repeat:** field, on the right of the screen.
7. If you selected a value less than 24 hours in step 6, select check buttons for the days of the week QC measurements must be done.
8. Tap the **OK** button.
9. Tap the **Close** button.

To edit the schedule for ampoule-based QC measurements

1. Tap **Menu > Utilities > Setup > QC setup > QC schedule**.
2. Select the scheduled measurement you want to edit. Scheduled ampoule-based measurements are marked by diamond-shaped icons.
3. Choose an option and follow the steps for it.

Option	Steps
To only delete the selected scheduled measurement	<ol style="list-style-type: none"> a) Tap the Delete button. b) Tap the Event for this day.
To delete all measurements with the selected solution that are scheduled at this time of the day	<ol style="list-style-type: none"> a) Tap the Delete button. b) Tap the Event for all days.
To delete all scheduled measurements with the selected solution	<ol style="list-style-type: none"> a) Tap the Delete button. b) Tap the All entries for QC slot <n>. <p>Note: <n> is a number.</p>
To change the days of the week measurements must be done	<ol style="list-style-type: none"> a) Tap the Edit button. b) Tap in the Weekdays: field. c) Select the check buttons for the days of the week measurements must be done. d) Tap the OK button.
To change the start time for measurements	<ol style="list-style-type: none"> a) Tap the Edit button. b) Tap the Start time: field. c) Enter a new start time. d) Tap the OK button.
To change how frequently measurements must be done	<ol style="list-style-type: none"> a) Tap the Edit button. b) Tap the Repeat: field. c) Select a value from the field on the right of the screen. d) Tap the OK button.

4. Tap the **Close** button.

Built-in QC measurement frequency

A built-in QC measurement is scheduled by default to be done every 8 hours. One measurement a day is done with each QC solution. Built-in QC measurements are also scheduled by default to be done in connection with these activities:

- Replacement of the Solution Pack
- Replacement of the Sensor Cassette
- Startup

You can edit the schedule for built-in QC measurements.

To edit the schedule for built-in QC measurements

Prerequisite: The schedule for built-in QC measurements is not linked to the calibration schedule.

1. Tap **Menu > Utilities > Setup > QC setup > QC schedule.**
2. Select the scheduled built-in QC measurement you want to edit. Scheduled built-in QC measurements are marked by diamond-shaped icons and stars.

Note: Built-in QC measurements are done with QC solutions registered in slots A, B and C.

3. Choose an option and follow the steps for it.

Option	Steps
To restore the default setup for scheduled built-in QC measurements	Tap the Reset Built-in QC button.
To only delete the selected scheduled measurement	<p>a) Tap the Delete button.</p> <p>b) Tap the Event for this day.</p>
To delete all measurements with the selected solution that are scheduled at this time of the day	<p>a) Tap the Delete button.</p> <p>b) Tap the Event for all days.</p>
To delete all scheduled measurements with the selected solution	<p>a) Tap the Delete button.</p> <p>b) Tap the All entries for QC slot <n>.</p>
To change the days of the week measurements must be done	<p>a) Tap the Edit button.</p> <p>b) Tap in the Weekdays: field.</p> <p>c) Select the check buttons for the days of the week measurements must be done.</p> <p>d) Tap the OK button.</p>
To change the start time for measurements	<p>a) Tap the Edit button.</p> <p>b) Tap the Start time: field.</p> <p>c) Enter a new start time.</p> <p>d) Tap the OK button.</p>
To change how frequently measurements must be done	<p>a) Tap the Edit button.</p> <p>b) Tap the Repeat: field.</p> <p>c) Select a value from the field on the right of the screen.</p> <p>d) Tap the OK button.</p>
To schedule built-in QC measurements to be done after replacement and startup procedures	This is the default setting. Radiometer recommends that you do not change this setting.
To remove built-in QC measurements after replacement and startup from the schedule	<p>Radiometer recommends that you do not use this option.</p> <p>Deselect the Run built-in QCs after replacement and startup check button.</p> <p>Note: If this option is selected, Radiometer recommends that you do ampoule-based QC measurements after replacement and startup procedures.</p>

4. Tap the **Close** button.

5. If a pop-up screen is shown, choose an option and follow the steps for it.

Option	Steps
To accept the new schedule	Tap the Accept button.
To change the schedule	<ul style="list-style-type: none"> Tap the Back button. Do steps 3 to 5 again.

Related information

To link the built-in QC schedule to the calibration schedule, page 176

To request ampoule-based QC measurements after replacements

This procedure lets you set up the analyzer to request ampoule-based QC measurements after Sensor Cassette and/or Solution Pack replacements. The analyzer will be locked until the ampoule-based QC measurements are done.

1. Tap **Menu > Utilities > Setup > QC setup > QC solutions**.
2. Select the QC solution to be used for an ampoule-based QC measurement.
3. Choose an option and follow the steps for it.

Option	Steps
To request ampoule-based QC measurements after Solution Pack replacements	a) Select the Request QC after Solution Pack replacement check button.
To request ampoule-based QC measurements after Sensor Cassette replacements	a) Select the Request QC after Sensor Cassette replacement check button.

4. Do steps 2 and 3 again for each QC solution to be used for an ampoule-based QC measurement after a replacement.
5. Tap the **Close button**.

Corrective actions on QC results

To set up corrective action for errors in QC results

Three corrective actions are available to show errors in QC results.

- Attach a question mark symbol to patient results until the QC error is removed
- Select the color of traffic light shown on the left side of the **Quality control** button in the **Analyzer status** screen.
- Do not show patient results for parameters with QC or other errors. See *Related information*.

Note: A successful QC measurement can remove the error.

1. Tap **Menu > Utilities > Setup > General setup > Corrective actions**.
2. Select the condition "QC error(s) present".
3. Choose an option and follow the steps for it.

Option	Steps
To change the traffic light color	a) Make sure the ? on specific parameters check button is deselected. b) Tap the traffic light symbol until it shows the color you want.
To attach a question mark symbol to patient results	Select the ? on specific parameters check button. Note: This option will also set the traffic light color to yellow.

4. Tap the **Close button**.

Related information

To repress a parameter, page 170

To set up corrective actions for overdue scheduled QC measurements

Three corrective actions are available to show that scheduled QC measurements are overdue.

- Select the color of traffic light shown on the left side of the **Quality control** button in the **Analyzer status** screen.
- Attach a message about overdue QC measurements to all patient results until the measurements are successfully completed.
- Lock the analyzer

Note: When the analyzer is locked, no patient samples can be analyzed until overdue scheduled QC measurements are successfully completed.

1. Tap **Menu > Utilities > Setup > General setup > Corrective actions**.
2. Select the condition "QC schedule reminder(s)".
3. Choose the option you want and follow the steps for it.

Option	Steps
To change the traffic light color	Tap the traffic light symbol until it shows the color you want.
To attach a message to subsequent patient results	Select the Message on next patient result check button.
To lock the analyzer	Select the Lock analyzer when QC overdue check button.

4. Tap the **Close** button.

To apply operator-defined corrections to QC results

Operator-defined corrections refer to corrections made to the offset and slope for parameters.

1. Tap **Menu > Utilities > Setup > General setup > Miscellaneous setup**.
2. Select the **Apply parameter corrections to QC** check button.
3. Tap the **Close** button.

Related information

Limits for slope and offset values, page 173

To set up corrective action for errors in built-in QC measurements

This procedure lets you set up the analyzer to do built-in QC measurements again when there are errors in the built-in QC results.

1. Tap **Menu > Utilities > Setup > General setup > Corrective actions**.
2. Select the condition "Built-in QC error(s) present".
3. Select the **Rerun same level once** check button.
4. Tap the **Close** button.

QC statistics

To set up automatic print of built-in QC statistics

This procedure lets you set up the analyzer to automatically print QC statistics for built-in QC when you start to use a new lot of a QC solution.

1. Tap **Menu > Utilities > Setup > QC setup > QC statistics**.
2. Select the check button in the **Built-in QC** frame.
3. Tap the **Close** button.

Statistical factor

The statistical factor expands the control range to the statistical range, which is the range within which QC results must fall to be included in QC statistics.

Note: The statistical range = [Control range] × [Statistical factor]. Only QC results that fall within the statistical range are included in QC statistics.

To set the statistical factor

1. Tap **Menu > Utilities > Setup > QC setup > QC statistics**.
2. If necessary, enter a new value in the **Statistical factor used for value acceptance** field.
Note: The default value is 1.5.
3. Tap the **Close** button.

Westgard Rules

About Westgard Rules

Westgard Rules are a set of control rules that can be applied to QC results to help you do two things:

- Find errors in QC results. The symbol "W" is used to show when QC results have violated applied Westgard Rules.
- Find shifts or trends in QC results. This helps you assess the quality and validity of patient sample analyses.

Types of Westgard Rule

There are two types of rule.

- Warning rules. Rule 1_{2s} is the only warning rule.
- Rejection rules. Rules 1_{3s} , 2_{2s} , R_{4s} , 4_{1s} and 10_x are rejection rules.

Description of the lines used in Westgard rule illustrations

Line type	Description
.....	Shows ± 3 SD ranges
---	Shows control ranges (± 2 SD)

Line type	Description
_____	Shows the mean value

Westgard rules and corrective actions

The 4 Westgard rules (1:3s, 2:2s, R:4s and 4:1s) can be applied to built-in and ampoule-based QC results. Rule 4_{1s} and Rule 10_x can only be applied to ampoule-based QC results.

Rule 1:2s (also written 1_{2s}) is a warning rule.

Westgard rule 1 _{2s}		Corrective action
The QC result falls outside the mean ±2 SD range		Do a new measurement with QC material of the same type, level and lot number. <ul style="list-style-type: none"> • If the new result does not fall outside the mean ±2 SD range, the original QC result can be attributed to normal statistical variation. • If the new result falls outside the mean ±2 SD range, do what is necessary to be in compliance with your local QC regulations.

Rule 1:3s (also written 1_{3s}) is a rejection rule.

Westgard rule 1 _{3s}		Corrective action
The QC result falls outside the mean ±3 SD range		Do a new measurement with QC material of the same type, level and lot number. <ul style="list-style-type: none"> • If the new result does not falls outside the mean ±3 SD range, the original QC result can be attributed to normal statistical variation. • If the new result falls outside the mean ±3 SD range, do what is necessary to be in compliance with your local QC regulations.

Rule 2:2s (also written 2_{2s}) is a rejection rule.

Westgard rule 2 _{2s}		Corrective action
Two consecutive QC results fall outside and on the same side of the mean ±2 SD range		Do what is necessary to be in compliance with your local QC regulations.

Rule R:4s (also written R_{4s}) is a rejection rule.

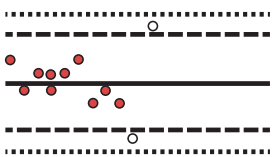
Westgard rule R_{4s}		Corrective action
<p>The difference between two consecutive QC results is greater than 4 SD</p>	 <p>This indicates that there is inconsistency in your QC procedures or your analyzer is not stable.</p>	<p>Do what is necessary to be in compliance with your local QC regulations.</p>

Rule 4:1s (also written 4_{1s}) is a rejection rule.

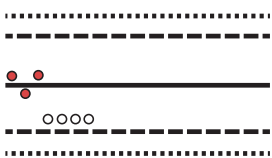
Westgard rule 4_{1s}		Corrective action
<p>Four consecutive QC results are on the same side of the mean ± 1 SD</p>	 <p>This indicates a trend or shift.</p>	<p>Do what is necessary to comply with your local QC regulations.</p> <p>Note: This rule can only be applied to ampoule-based QC results. Radiometer recommends that this rule is only applied if the parameter control ranges have been changed to analyzer-specific control ranges calculated from a minimum of 20 ampoule-based QC measurements.</p>

Rule 10:x (also written 10_x) is a rejection rule.

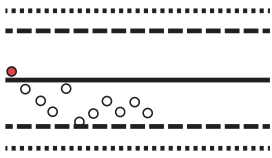
Westgard rule 10_x		Corrective action
<p>Ten consecutive QC results are on the same side of the mean</p>	 <p>This indicates a trend or shift.</p>	<p>Do what is necessary to comply with your local QC regulations.</p> <p>Note: This rule can only be applied to ampoule-based QC results. Radiometer recommends that this rule is only applied if the parameter control ranges have been changed to analyzer-specific control ranges calculated from a minimum of 20 ampoule-based QC measurements.</p>

To set up and enable Westgard Rules

This procedure lets you setup and enable Westgard Rules for selected QC solutions. The rules can be set up for built-in QC solutions and ampoule-based QC solutions.

1. Tap **Menu > Utilities > Setup > QC setup > Westgard Rules**.
2. Make sure that there is a checkmark on the **On/Off** button. If there is no checkmark, tap the button.
3. Tap the **Next slot** button to select the QC solution.

- Choose an option and follow the steps for it.

Option	Steps
To apply all Westgard rules to QC results for all parameters.	<ol style="list-style-type: none"> Tap the Select all button. <p>Note: Rule 4-1S and 10-X cannot be applied to QC solutions in slot A, slot B or slot C.</p> <ol style="list-style-type: none"> Tap the Continue button.
To apply some Westgard rules to QC results of some parameters	<ol style="list-style-type: none"> Select a parameter. Tap the Edit button. Select the check buttons of the rules you want to apply. If necessary, tap the Next param or Prev param button to select a new parameter and do step c) again.

- Tap the **Back > Close** buttons.

To disable/enable Westgard rules

Prerequisite: Westgard rules are set up.

This procedure lets you disable/enable the Westgard rules that are set up on all QC solutions.

- Tap **Menu > Utilities > Setup > QC setup > Westgard Rules**.
- Choose an option and follow the steps for it.

Option	Steps
To disable Westgard rules	Deselect the On/Off check button.
To enable Westgard rules	Select the On/Off check button.

- Tap the **Close** button.

RiLiBÄK rules

About RiLiBÄK rules

RiLiBÄK rules are guidelines of the German Federal Medical Council. The rules provide minimum requirements for the quality of quantitative test results in medical laboratories.

To add a new RiLiBÄK rule

This procedure lets you add a new rule.

- Tap **Menu > Utilities > Setup > QC setup > RiLiBÄK ranges**.
- Tap the **Add** button.
- Select the parameter you want.
- Tap in the first **Lower limit:** field.
- Enter the value of the lower limit.
- Tap in the second **Lower limit:** field.
- Tap **<** or **<=**.
- Tap in the first **Upper limit:** field.

9. Tap < or <=.
10. Tap in the second **Upper limit:** field.
11. Enter the value of the upper limit.
12. Choose an option and follow the steps for it.

Option	Steps
To use a percentage to calculate the acceptable deviation from the assigned value. The assigned value is the center value of the range you entered in step 5 and step 11. Note: This is the option most frequently chosen.	<ul style="list-style-type: none"> • Select the +/- Ranges [%] radio button. • Enter the percentage value in the Ranges: field.
To use an absolute value to calculate the acceptable deviation from the assigned value	<ul style="list-style-type: none"> • Select the +/- Ranges radio button. • Enter the absolute value in the Ranges: field.

13. Tap the **Back** button.
14. Do steps 2 to 13 again for each rule you want to add.
Note: More than one rule can be added for a parameter if the ranges for each rule do not overlap.
15. Tap the **Close** button.

To apply all RiLiBÄK rules

Prerequisite: RiLiBÄK rules are set up.

This procedure lets you apply all the RiLiBÄK rules that are set up. You cannot select which rules to apply.

1. Tap **Menu > Utilities > Setup > QC setup > RiLiBÄK ranges**.
2. Make sure there is a check mark on the **On/Off** button. If there is no check mark, tap the button.
3. Tap the **Close** button.

To edit a RiLiBÄK rule

1. Tap **Menu > Utilities > Setup > QC setup > RiLiBÄK ranges**.
2. Select the rule you want to edit.
3. Tap the **Edit** button.
4. Edit the values.
5. If necessary, choose an option and follow the steps for it.

Option	Steps
To use a percentage to calculate the acceptable deviation from the assigned value. Note: This is most frequently used.	<ul style="list-style-type: none"> • Select the +/- Ranges [%] radio button. • Enter the percentage value in the Ranges: field.
To use an absolute value to calculate the acceptable deviation from the assigned value.	<ul style="list-style-type: none"> • Select the +/- Ranges button. • Enter the absolute value in the Ranges: field.

6. Tap the **Back > Close** buttons.

To remove a RiLiBÄK rule

1. Tap **Menu > Utilities > Setup > QC setup > RiLiBÄK ranges**.
2. Select the rule you want to delete.
3. Tap the **Delete** button.
4. Tap the **Close** button.

Analyzer-specific control ranges

About analyzer-specific control ranges

If local, state or federal regulations require your laboratory to establish and use analyzer-specific control ranges for the QC solutions used for ampoule-based QC measurements, it can be done.

The analyzer-specific control ranges established in your laboratory must then be used to replace the default **Control range** values given to parameters when QC solutions are registered for use. The default values are the control ranges given on the product insert. These values are shown in the **Insert range** column of the **Quality control ranges setup** screen.

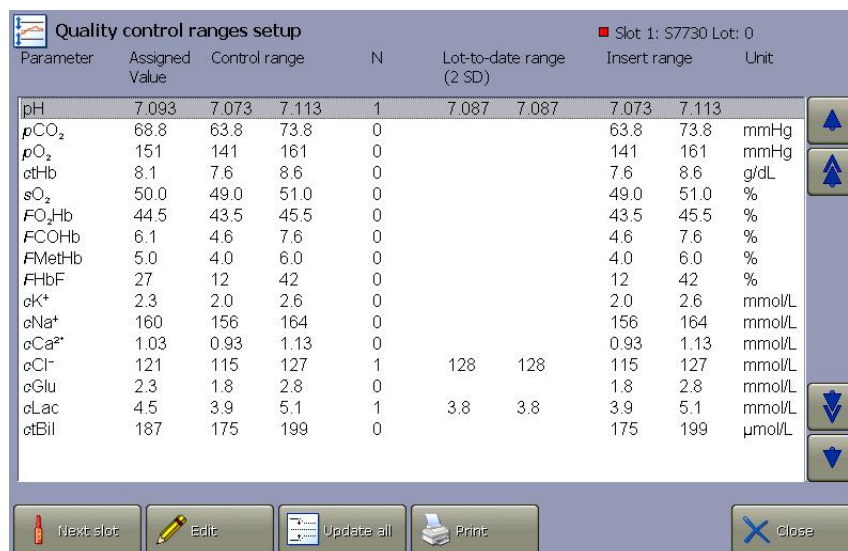

Quality control ranges setup Slot 1: S7730 Lot: 0

Parameter	Assigned Value	Control range		N	Lot-to-date range (2 SD)		Insert range		Unit
pH	7.093	7.073	7.113	1	7.087	7.087	7.073	7.113	
pCO ₂	68.8	63.8	73.8	0			63.8	73.8	mmHg
pO ₂	151	141	161	0			141	161	mmHg
ctHb	8.1	7.6	8.6	0			7.6	8.6	g/dL
sO ₂	50.0	49.0	51.0	0			49.0	51.0	%
FO ₂ Hb	44.5	43.5	45.5	0			43.5	45.5	%
FCOHb	6.1	4.6	7.6	0			4.6	7.6	%
FMetHb	5.0	4.0	6.0	0			4.0	6.0	%
FHbF	27	12	42	0			12	42	%
cK ⁺	2.3	2.0	2.6	0			2.0	2.6	mmol/L
cNa ⁺	160	156	164	0			156	164	mmol/L
cCa ²⁺	1.03	0.93	1.13	0			0.93	1.13	mmol/L
cCl ⁻	121	115	127	1	128	128	115	127	mmol/L
cGlu	2.3	1.8	2.8	0			1.8	2.8	mmol/L
cLac	4.5	3.9	5.1	1	3.8	3.8	3.9	5.1	mmol/L
ctBil	187	175	199	0			175	199	µmol/L

Buttons: Next slot, Edit, Update all, Print, Close

The control range values given in the insert are not analyzer-specific. They were established as follows: QC measurements were done on a number of ABL90 FLEX analyzers. Different lots of QC solution were used. Measurements were done by different operators, over several days. Different Solution Packs were also used to take lot-to-lot variations of calibration solutions into account.

How to establish analyzer-specific control ranges

Establishment of analyzer-specific control ranges is a 3-stage process:

- Stage 1: Do 20 ampoule-based QC measurements with each level of QC solution.
- Stage 2: Enable the use of **Fixed SD** values to parameters to make sure that the lot-to-date ranges calculated in stage 3 are not made too narrow.
- Stage 3: Use the analyzer to change control ranges to lot-to-date ranges.

Stage 1: To do 20 ampoule-based QC measurements

Prerequisites:

- Radiometer QUALICHECK5+ quality control solutions are registered for use
- The QC ampoules are prepared for use
- Make sure that the analyzer is **Ready**

Note: This procedure is only necessary if local, state and federal regulations require you to do ampoule-based QC measurements that are based on analyzer-specific control ranges established by your laboratory.

Radiometer recommends that measurements done in this procedure are done by more than one person over a period of 4-5 days. This will take into account sample-to-sample, operator-to-operator and day-to-day variations.

1. Do a minimum of 20 ampoule-based QC measurements with each level of QC solution.

Related information

Data saved during registration of Radiometer QC solutions, page 178

To prepare a Radiometer QC ampoule for use, page 69

Stage 2: To enable the use of fixed standard deviations

You can use this procedure to make sure that the analyzer-specific control ranges calculated in stage 3 of the process are not made too narrow. The **Fixed SD** values enabled for use during this procedure are only used when they are found to be greater than the calculated standard deviations of the measurements made in stage 1 of the process.

1. Tap **Menu > Utilities > Setup > QC setup > QC ranges**.
2. Tap the **Next slot** button to find the QC solution you want to edit.
3. Select the parameter.
4. Tap the **Edit** button.
5. Select the check button in the **Fixed SD** field.

Note: The value shown is a Radiometer value.

6. Tap the **Next param .** or **Prev param.** button to select a new parameter.
7. Select the check button in the **Fixed SD** field.
8. Do steps 6 and 7 again for each parameter.
9. Tap the **Back > Close** buttons.

Stage 3: To use the analyzer to change control ranges to analyzer-specific control ranges

Note: Radiometer recommends that you do Stage 1 and 2 of the process before you do stage 3.

The analyzer uses all successful QC results to calculate the mean value and standard deviation (SD) values of parameters. The lot-to-date range is calculated as follows:

Lot-to-date range = [Mean value] ± [2 × calculated SD value]

The analyzer then updates the **Control range** of parameters. It compares the calculated SD values with the **Fixed SD** values that were enabled for use in stage 2 of the process.

- If a [calculated SD value] > [**Fixed SD** value], the control range of the parameter is changed to the lot-to-date range
- If a [calculated SD value] < [**Fixed SD** value], the control range of the parameter is changed to the control range calculated as follows:

$$\text{Control range} = [\text{Mean value}] \pm [2 \times \text{Fixed SD value}].$$

This makes sure that the control ranges are not made too narrow.

1. Tap **Menu > Utilities > Setup > QC setup > QC ranges**.

Note: The number of successful QC measurements are shown in the **N** column.

2. Tap the **Next slot** button to find the QC solution you want to edit.
3. Tap the **Update all** button.

Note: The control ranges of all parameters are now analyzer-specific.

4. Tap the **Back > Close** buttons.

To manually change control ranges to analyzer-specific control ranges

Prerequisite: Established analyzer-specific control ranges.

Note: This procedure is only necessary if local, state and federal regulations require you to do ampoule-based QC measurements that are based on analyzer-specific control ranges established by your laboratory. The procedure lets to change the control ranges manually.

1. Tap **Menu > Utilities > Setup > QC setup > QC ranges**.

Parameter	Assigned Value	Control range		N	Lot-to-date range (2 SD)		Insert range		Unit
pH	7.093	7.073	7.113	1	7.087	7.087	7.073	7.113	
pCO ₂	68.8	63.8	73.8	0			63.8	73.8	mmHg
pO ₂	151	141	161	0			141	161	mmHg
ctHb	8.1	7.6	8.6	0			7.6	8.6	g/dL
sO ₂	50.0	49.0	51.0	0			49.0	51.0	%
FO ₂ Hb	44.5	43.5	45.5	0			43.5	45.5	%
FCOHb	6.1	4.6	7.6	0			4.6	7.6	%
FMetHb	5.0	4.0	6.0	0			4.0	6.0	%
FHbF	27	12	42	0			12	42	%
ck ⁺	2.3	2.0	2.6	0			2.0	2.6	mmol/L
cNa ⁺	160	156	164	0			156	164	mmol/L
cCa ²⁺	1.03	0.93	1.13	0			0.93	1.13	mmol/L
cCl ⁻	121	115	127	1	128	128	115	127	mmol/L
cGlu	2.3	1.8	2.8	0			1.8	2.8	mmol/L
cLac	4.5	3.9	5.1	1	3.8	3.8	3.9	5.1	mmol/L
ctBil	187	175	199	0			175	199	µmol/L

2. Tap the **Next slot** button to find the specific lot and level of QC solution you want to edit.
3. Select a parameter.

4. Tap the **Edit** button.

The screenshot shows the 'Edit control ranges' interface for the parameter 'pH'. The title bar includes 'Edit control ranges', 'Parameter: pH', and 'Slot 1: S7730 Lot: 0'. The interface is divided into three main sections on the left and a numeric keypad on the right. The 'Current control range' section has two input boxes containing '7.073' and '7.113'. The 'Lot-to-date range (2 SD)' section has two input boxes containing '7.087' and '7.087'. The 'Fixed SD' section has a checkbox labeled 'Use fixed SD when updating ranges' which is currently unchecked. The numeric keypad on the right contains digits 0-9, a decimal point, and three arrow keys (left, right, and a combined left/right arrow). At the bottom, there are four buttons: 'Next param.' (with a right arrow), 'Prev param.' (with a left arrow), 'Update' (with a refresh icon), and 'Back' (with a left arrow).

5. Enter the values of the analyzer-specific control range in the **Current control range** frame.
6. To change the control range of the other parameters, do as follows for each parameter:
- Tap the **Next param.** button.
 - Do step 5 again.
7. Tap the **Back** button.
- Note:** The entered values are shown in the **Control range** column of the **Quality control ranges setup** screen.
8. Tap the **Close** button.

Maintenance setup

About mandatory and operator-defined activities

There are 2 types of maintenance activity:

- Mandatory – activities that must be done
- Operator-defined – activities that can be set up by operators

Mandatory maintenance activities

Other activities

Other activities are mandatory replacement activities that are scheduled or can be scheduled to be run at regular intervals of time. For example, to clean the screen.

Other activities are shown in the **Other activities** part of the **Analyzer status** screen. When a scheduled activity is due, a reminder is shown in the **Analyzer status** screen.

To schedule other activities

1. Tap **Menu > Utilities > Setup > Replacement setup > Replacement schedule**.
2. Select the activity in the **Replacements** column.
3. Tap the **Edit** button.
4. Select the frequency for the activity in the **Interval** field.

Note: The first date for the scheduled activity is shown in the **Next date** field. The time is equal to the current date plus the number of days selected in the **Interval** field.

5. Choose an option and follow the steps for it.

Option	Steps
To change the first date for the scheduled activity	<ol style="list-style-type: none"> a) Tap in the Next date field. b) Enter a new date.
To accept the first date for the scheduled activity	Go to the next step.

6. Tap the **Back > Close** buttons.

To set up corrective action for overdue Other activities

Prerequisite: Other activities are scheduled.

Three corrective actions are available to show that scheduled **Other activities** are overdue.

- Select the color of traffic light shown on the left side of the **Other activities** button in the **Analyzer status** screen.
- Attach a message about overdue scheduled activities to all patient results until the activities are successfully completed.
- Lock the analyzer when a scheduled activity is more than 10 % overdue.

Note: When the analyzer is locked, no patient samples can be analyzed until overdue scheduled activities are successfully completed.

For example: If an activity is scheduled to be done every 10 days and the activity is not done [10 days + (10 % of 10 = 1) day] = 11 days after the activity was last done, the analyzer locks.

1. Tap **Menu > Utilities > Setup > General setup > Corrective actions**.
2. Select the condition "Replacement schedule reminder(s)".
3. Choose the option you want and follow the steps for it.

Option	Steps
To change the traffic light color	Tap the traffic light symbol until it shows the color you want.
To attach a message to subsequent patient results	Select the Message on next patient result check button.
To lock the analyzer when the activity is more than 10 % overdue	Select the Lock analyzer when 10 % overdue check button.

Operator-defined activities

Operator activities

Operator activities are activities you can set up and schedule to be done at regular intervals of time. For example, to clean the touch screen and analyzer exterior. When a scheduled activity is due, a message is sent as a reminder to do the activity.

To set up an operator activity

1. Tap **Menu > Utilities > Setup > Replacement setup > Operator activities**.
2. Tap the **Add** button.
3. Enter a name for the activity.
4. Select the frequency for the activity in the **Interval** field.

Note: The first date for the scheduled activity is shown in the **Next date** field. The time is equal to the current date plus the number of days selected in the **Interval** field.

5. Choose an option and follow the steps for it.

Option	Steps
To change the first date for the scheduled activity	a) Tap in the Next date field. b) Enter a new date.
To accept the first date for the scheduled activity	Go to the next step.

6. Tap the **Back > Close** buttons.

To set up corrective action for pending operator activities

This procedure lets you set up the analyzer to change the color of the traffic light shown on the left side of the **Other activities** button in the **Analyzer status** screen to remind operators about pending operator activities.

1. Tap **Menu > Utilities > Setup > General setup > Corrective actions**.
2. Select the condition "Operator activity reminder(s)".
3. Tap the button with the traffic light symbol to select the color you want to show.
4. Tap the **Close** button.

To delete an operator activity

1. Tap **Menu > Utilities > Setup > Replacement setup > Operator activities**.
2. Select the activity.
3. Tap the **Delete** button.
4. Tap the **Continue** button.
5. Tap the **Close** button.

Maintenance planning

To plan maintenance activities

This procedure lets you enter the periods of time that people who maintain the analyzer are available each day. The analyzer uses this information to send reminders

about maintenance activities so they can be done when people who maintain the analyzer are available. This procedure can be used to decrease analyzer down time.

1. Tap **Menu > Utilities > Setup > Replacement setup > Maintenance planning**.
2. Select the check button for the days that people who maintain the analyzer are available.
3. Enter the start and end time that people who maintain the analyzer are available.
4. Tap the **Close** button.

Replacement warnings

To set up replacement warnings

Replacement warnings are messages that can be set up to tell operators that installed consumables (Solution Pack/Sensor Cassette) will soon have to be replaced. You can set up two conditions to cause a message to be sent.

- the number of remaining activities/tests falls below a selected value
- the number of hours that remain before a consumable expires falls below a selected value

1. Tap **Menu > Utilities > Setup > Replacement setup > Replacement warnings**.
2. Select a number in the **Expected measurements per day** field, so the analyzer can calculate the most probable replacement date.
3. Select a number in the **Number of tests before replacement warning** field.
4. Select a time period in the **Time before replacement warning** field.
5. Tap the **Close** button.

Note fields

To create standard texts for use in Note fields

1. Tap **Menu > Utilities > Setup > General setup > Parameters and input > User-defined notes**.
2. Select the check button for the screen where you want standard text to be available for use in the **Note** field.
3. Tap the **Add** button.
4. Enter the standard text.
5. Do steps 3 and 4 again for each standard text you want to add.
6. Tap the **Close** button.

To edit standard texts for use in Note fields

1. Tap **Menu > Utilities > Setup > General setup > Parameters and input > User-defined notes**.
2. Select the note you want to edit.
3. Tap the **Edit** button.
4. Edit the note.
5. Tap the **Close** button.

To delete standard texts for use in Note fields

1. Tap **Menu > Utilities > Setup > General setup > Parameters and input > User-defined notes.**
2. Select the note you want to delete.
3. Tap the **Delete** button.
4. Tap the **Close** button.

Communications

To set up a LIS/HIS connection

Prerequisite: Connection to a network.

1. Tap **Menu > Utilities > Setup > General setup > Communications > LIS/HIS connection.**
2. Tap the **Add** button.
3. Enter a name for the connection.
4. Tap the **Back** button.
5. Select the high-level protocol used by the LIS/HIS system.
6. Choose an option and follow the steps for it.

Option	Steps
To set up a serial low-level protocol	<ol style="list-style-type: none"> a) Select a serial setting. b) Tap the Edit button. c) Tap the Edit button again. d) If necessary, change the settings. e) Tap the Back > Back > Close buttons.
To set up a network low-level protocol	<ol style="list-style-type: none"> a) Select a network setting. b) Tap the Edit button. c) If necessary, change the settings. d) Tap the Back > Close buttons.

To set up a AQUIRE/RADIANCE connection

1. Tap **Menu > Utilities > Setup > General setup > Communications > AQUIRE/RADIANCE connection.**
2. Enter the address of the AQUIRE/RADIANCE server the analyzer is connected to.
3. Enter the number of the AQUIRE/RADIANCE server port the analyzer is connected to.
4. Enter the password the analyzer was given to access the AQUIRE/RADIANCE system.
5. Select the **Communicate with AQUIRE/RADIANCE** checkbox.
Note: The status "Connected" is shown in the **Connection status** frame.
6. Tap the **Close** button.

At the bottom of the analyzer screen the icon shows if there is a connection or not:

Icon	Explanation
	There is a connection between the system and the analyzer

Icon	Explanation
	There is no connection between the system and the analyzer

Patient data from a LIS/HIS or AQUIRE/RADIANCE system

Patient data can be downloaded to the analyzer from a connected LIS/HIS or AQUIRE/RADIANCE system.

You can set up the analyzer to request patient data automatically from the system, or let operators request patient data manually. There are 2 options for manual requests:

- Fill in the **Accession number, Patient ID** or **Sampler ID** field in the **Patient identification** screen and request the patient data.
- Fill in the **Patient department** field in the **Patient identification** screen, lookup, find and request the patient data.

Note: To use this option, you must enable patient lookup.

To set up automatic requests for patient data

Prerequisite: A connection is set up to the LIS/HIS or AQUIRE/RADIANCE system that patient data is to be requested from.

1. Tap **Menu > Utilities > Setup > General setup > Communications > Automatic data request**.
2. Select the connection to the system that patient data is to be requested from.
3. In the **Request patient demographics** frame, select the check button for the data field in the **Patient identification** screen that when filled in will automatically request patient data from the system.

Note: It is possible to select more than one check button, but Radiometer recommends that you only select one.

4. Tap the **Close** button.

To set up automatic transmission of data to a system

Prerequisite: A connection is set up to the LIS/HIS and/or AQUIRE/RADIANCE system that data is to be sent to.

1. Tap **Menu > Utilities > Setup > General setup > Communications > Automatic data transmission**.
2. Select the name of the connection.
3. Select the check buttons for the data to be automatically sent.
4. Do steps 2 and 3 again for each system that you want to transmit data to.
5. Tap the **Close** button.

To enable manual patient data requests using Patient lookup

Prerequisites:

- If data is to be requested from an LIS/HIS or AQUIRE/RADIANCE system, a connection must be set up to the system
- The selected **Patient report** contains the **Department (Pat.)** field

Patient data can be requested from the analyzer database, a connected LIS/HIS or AQUIRE/RADIANCE system.

This procedure lets operators request patient data manually, via a **Patient lookup** button, after they have filled in the **Department (Pat.)** field of the **Patient identification** screen.

1. Tap **Menu > Utilities > Setup > General setup > Communications > Patient lookup setup**.
2. Select the name of the connection.
3. Select the number of days after patient data is saved in the **Patient profiles log** that it must be available for use. The default is 7 days.
4. Tap the **Close** screen.

To access the RADIANCE system from the analyzer

Prerequisites:

- A connection to the RADIANCE system. This must be set up.
 - Access to the RADIANCE system. Access is available on request. Contact your local Radiometer representative.
1. Make sure the RADIANCE icon shows there is connection between the analyzer and the RADIANCE system.
If there is a connection, this icon is shown: 
 2. Tap **Menu > Utilities > RADIANCE browser**.
Note: See the *RADIANCE system, User's manual* for instructions.

To set up a QA Portal connection

1. Tap **Menu > Utilities > Setup > General setup > Communications > QA Portal connection**.
2. Enter the TCP/IP address of the QA Portal server the analyzer is connected to.
3. Enter the number of the QA Portal server port the analyzer is connected to.
4. Select the **Communicate with QA Portal** check button.
Note: The **Connection status** frame shows whether or not there is a connection.
5. Tap the **Close** button.

Printers

To set up automatic printing

1. Tap **Menu > Utilities > Setup > General setup > Printers > Automatic printing**.
2. Select the check buttons for the data you want to be printed automatically.
Note: If you select the **QC results** check button, built-in and ampoule-based QC measurement results will be printed.
3. Select the number of copies of patient results that must be printed.
4. Tap the **Close** button.

To install an external printer for the analyzer

This procedure must be done by your local Radiometer representative.

1. Tap **Menu > Utilities > Setup > General setup > Printers > Printer setup.**
2. Tap the **Install printer** button and follow the instructions shown on the screen.
3. If necessary, tap the **Edit name** button and enter the new name.
4. Do step 2 and 3 again for each printer you want to install.

Note: Radiometer recommends that a maximum of 10 printers are installed.

5. Choose an option and follow the steps for it.

Option	Steps
To print data on the same printers each time	<ol style="list-style-type: none"> a) Select the printer. b) Tap the Select/deselect button. c) Make sure a check mark is shown adjacent to the printer name. d) Do steps a) to c) again for each printer.
To get a list of the installed printers before you print data	Select the check button in the Manual printing frame.
To print data on all installed printers	Make sure that the check button in the Manual printing frame is deselected.

6. Tap the **Close** button.

To edit the name of a printer

1. Tap **Menu > Utilities > Setup > General setup > Printers > Printer setup.**
2. Select the printer.
3. Tap the **Edit name** button, and enter the new name.
4. Tap the **Close** button.

Data logs and archives

About data logs and archived data logs

The analyzer can be set up to automatically save data logs to archives on the analyzer or on an external device. Data is moved to the archives when the data logs are full.

You can export data logs and archived data logs manually and save them on an external device. You can also import archives from other ABL90 FLEX analyzers.

To set up automatic archiving

1. Tap **Menu > Utilities > Setup > General setup > Disk functions setup > Automatic archiving**.
2. Select the check buttons for the data logs that you want to be archived.
3. Choose an option and follow the steps for it:

Option	Steps
To archive the data logs on the analyzer	<p>a) Select the Store archives on the analyzer check button.</p> <p>b) Tap the Close button.</p> <p>Note: The data is saved on the D: drive.</p>
To archive the data logs to a different destination	<p>a) Deselect the Store archives on the analyzer check button.</p> <p>b) Select an external drive.</p> <p>c) Tap the button with the folder icon.</p> <p>d) Select the folder where the data logs must be archived.</p> <p>e) Tap the Back > Close buttons.</p>

File format of exported data logs and archived data logs

Data logs can be exported as compressed Comma Separated Value (CSV) files. The CSV files can be read by database and spreadsheet programs. For example: Microsoft Excel, Access and Lotus 1-2-3.

However, archived data logs can also be exported as .bin files. The .bin files are encrypted. If you want to read them, you must import them to the analyzer.

To export data logs

This procedure lets you export one or more data log from the analyzer in .csv format.

Note: Data logs are not removed from the analyzer during this procedure. The exported data logs are only copies.

1. Make sure that there is a connection between the analyzer and the device to which the logs are to be exported.
2. Tap **Menu > Utilities > Disk functions > Export data logs**.
3. Deselect the check buttons for the data logs that you do not want to export.
4. Tap the button with the calendar icon in the **Date interval** frame.
5. Enter a date in the **From:** and **To:** fields.
6. Tap the **Back** button.
7. Tap the check button on the right side of the **Directory:** field.
8. Select the folder on the external drive you want to export the data logs to.
9. Tap the **Back** button.
10. Tap the **Start** button.
11. Tap the **Start** button.

To export data from Archived data logs

This procedure lets you export part of an archived data log from the analyzer in .csv format.

1. Make sure that there is a connection between the analyzer and the device to which the archive is to be exported.
2. Tap **Menu > Data logs > Archived data logs**.
3. Select the archive type.
4. Select a date interval.
5. Tap the **Export archive** button.
6. Select the folder on the external drive that you want to export the archived data log to.
7. Tap the **Back** button.
8. Tap the **Start** button.

To create disc space by exporting and deleting archives

This procedure lets you export archives to an external system and then delete them from the analyzer database to create space. The files are moved in .bin format. They cannot be read by database or spreadsheet programs. They must be imported to the analyzer to be read.

1. Make sure that there is a connection between the analyzer and the device to which the archive parts are to be exported.
2. Tap **Menu > Utilities > Disk functions > Import / Export archives**.
3. Select the archive type.
4. Select an archive.
5. Tap the button with the folder icon in the **Source/Destination:** frame.
6. Select the folder to export the archive to.
7. Tap the **Back** button.
8. Tap the **Export** button.
9. In the **Archives stored on analyzer:** frame:
 - a) Select the archive that you selected in step 4 and have just exported.
 - b) Tap the **Delete** button.
10. Do steps 3 to 9 again for each archive you want to export and delete.
11. Tap the **Close** button.

To import archived data logs

1. Make sure that there is a connection between the analyzer and the device that contains the archives.
2. Tap **Menu > Utilities > Disk functions > Import / Export archives**.
3. Select the archive type.
4. Tap the button with the folder icon in the **Source/destination** frame.
5. Select the folder that contains the archives you want to import.
6. Tap the **Back** button.
7. Select one of the archives in the **Source/destination** frame.
8. Tap the **Import** button.
9. If necessary, do steps 7 and 8 again.
10. Tap the **Close** button.

Data backup and restoration

Backup

A backup includes all data logs and system files. Backup can be set up to be done automatically. The backup can also be done manually.

If data is lost or damaged, the backup will restore most of the data and keep data loss to a minimum.

Note: The customer must make sure that a backup is done regularly.

Destinations for backup data

A backup can be saved to these destinations.

- A USB flash drive
- An external CD drive
- A folder on an external network drive

To schedule automatic backups

1. Create a folder for the backup on the device on which the backup is to be saved.
2. Make sure that there is a connection between the analyzer and the device.
3. Tap **Menu > Utilities > Setup > General setup > Disk functions setup > Automatic backup**.
4. Select the **Automatic backup of all data- and system files** check button.
5. Enter the time.
6. Enter the number of days between subsequent backups.
7. Tap the button with the folder icon.
8. Select the folder where the backup is to be saved.
9. Tap the **Back > Close** buttons.

To do a manual backup

1. Create a folder for the backup on the device on which the backup is to be saved.
2. Make sure that there is a connection between the analyzer and the device.
3. Tap **Menu > Utilities > Disk functions > Backup all data**.
4. Tap the **Change destination** button.
5. Select the folder where the backup is to be saved.
6. Tap the **Back** button.
7. Tap the **Start** button.
8. Look at the screen. A message will tell you when the backup is done.
Note: A message is shown on the screen if the backup cannot be done.
9. Tap the **Close** button.

To restore data from a backup

Prerequisite: The latest backup

1. Make sure that there is a connection between the analyzer and the device that contains the backup.
2. Tap **Menu > Utilities > Disk functions > Restore all data**.
3. Tap the **Change source** button.

4. Select the folder that contains the backup.
5. Tap the **Back** button.
6. Tap the **Start** button.

Note: When data is restored, the analyzer shuts down and restarts.

Saving and loading setups

To save the setup

1. Create a folder for the setup on the device on which the setup is to be saved.
2. Make sure that there is a connection between the analyzer and the device on which the setup is to be saved.
3. Tap **Menu > Utilities > Disk functions > Save setup**.
4. Tap the **Edit location** button.
5. Select the folder where the setup is to be saved.
6. Tap the **Back** button.
7. Tap the **Start** button.
8. Wait until a message tells you that the setup is saved.
9. Tap the **Close** button.

To load a setup

1. Make sure that there is a connection between the analyzer and the device from which the setup is to be loaded.
2. Tap **Menu > Utilities > Disk functions > Load setup**.
3. Choose an option and follow the steps for it.

Option	Steps
To load all parts of the setup	Select the All check box.
To load one or more parts of the setup	<ol style="list-style-type: none"> a) Deselect the All check box. b) Select the check boxes of the setups you want to load.

4. Tap the **Change source** button.
5. Select the folder from which the setup is to be loaded.
6. Tap the **Back** button.
7. Tap the **Continue** button.

Note: The analyzer will shut down and restart with the new setup.

To restore Radiometer default settings

1. Tap **Menu > Utilities > Disk functions > Restore default setup**.
2. Choose an option and follow the steps for it.

Option	Steps
To restore all default settings	Select the All check box.
To restore one or more default settings	<ol style="list-style-type: none"> a) Deselect the All check box. b) Select the check boxes of the default settings you want to restore.

3. Tap the **Continue** button.

Note: The analyzer will shut down and restart with the new setup.

Radiometer default settings

Operators and profiles - default settings

Item	Default setting
Operators	Radiometer, Remote operator, Manager
Access profiles	Service technician, Remote operator, Manager
Logoff time	3 minutes
Anonymous access enabled	Yes
Access profile for anonymous operator	User
Authenticate operator by	Logon-barcode as primary

Access profile	Access to activities												
	A	B	C	D	E	F	G	H	I	J	K	L	M
Operator	X	X	X	X	X		X	X	X	X	X	X	X
Supervisor	X	X	X	X	X	X	X	X	X	X	X	X	X
Manager	X	X	X	X	X	X	X	X	X	X	X	X	X
Service technician	X	X	X	X	X	X	X	X	X	X	X	X	X
Guest	X		X					X		X	X	X	X
Custom 1			X							X	X	X	X
Custom 2			X							X	X	X	X
Custom 3			X							X	X	X	X
Remote operator	X	X	X	X	X		X	X	X	X	X	X	X

Activity	Description
A	Perform measurements
B	Perform calibrations
C	Perform operator Activities
D	Edit data in logs
E	Perform built-in QC
F	Approve results
G	Replace the Sensor Cassette
H	Clean the Inlet Gasket
I	Replace the Inlet Gasket Holder
J	Replace the Solution Pack
K	Replace the Inlet Connector Gasket

Activity	Description
L	Flush the analyzer
M	Replace the Inlet Probe

Alarm sound (acoustic signal) settings for events - default settings

Event	Default setting
Value exceeds critical range	No
Close inlet	Yes
Result is ready	Yes
Inlet is open too long	Yes

Language - default setting

Item	Default setting
Screen language	English

Analysis setup – default settings

Analysis setup	Default setting
Syringe sample modes	<ul style="list-style-type: none"> Syringe - S 65µL <p>Note: All user-defined modes are removed.</p>
Capillary sample modes	<p>C 65µL</p> <p>Note: All user-defined modes are removed.</p>
Parameter profiles	<p>All parameters are selected.</p> <p>Use dynamic parameters is off.</p>
Sample pre-registration setup	<ul style="list-style-type: none"> Interpret barcode input as: Sampler ID Included fields: Sampler ID, Patient first name, Patient last name, Birth date, Patient sex, Accession no.
Sample age evaluation setup	<p>Enable calculation of sample age: Yes (30 minutes for all parameters)</p>
Patient report setup	<ul style="list-style-type: none"> Layouts: -R- Default Patient ID layout settings included in the -R- Default layout: <ul style="list-style-type: none"> Patient ID Patient last name Patient first name Sample type (Not specified) Temperature (T), 37.0 °C Patient result settings included in the -R- Default layout (bold text = a new title; [xxx - xxx] = the reference range for a parameter)

Analysis setup	Default setting	
Patient report setup	Blood gas values	
	pH	[xxx - xxx]
	pCO ₂	[xxx - xxx]
	pO ₂	[xxx - xxx]
	<New line>	
	Oximetry values	
	ctHb	[xxx - xxx]
	sO ₂	[xxx - xxx]
	FO ₂ Hb	[xxx - xxx]
	FCOHb	[xxx - xxx]
	FHHb	[xxx - xxx]
	FMetHb	[xxx - xxx]
	FHbF	[xxx - xxx]
	<New line>	
	Electrolyte values	
	cK ⁺	[xxx - xxx]
	cNa ⁺	[xxx - xxx]
	cCa ²⁺	[xxx - xxx]
	cCl ⁻	[xxx - xxx]
	<New line>	
	Metabolite values	
	cGlu	[xxx - xxx]
	cLac	[xxx - xxx]
	ctBil*	[xxx - xxx]
	<New page>	
	Temperature-corrected values	
	pH(T)	
	pCO ₂ (T)	
	pO ₂ (T)	
	<New group>	
Oxygen status		
ctO ₂		
p50		

Analysis setup	Default setting
Patient report setup	<New line>
	Acid-base status
	cBase(Ecf)
	cHCO ₃ ⁻ (P,st)

* Bilirubin can only be measured on neonatal samples. This parameter is only available in the Neonate blood analysis 65 µL mode.

Parameters - default settings

The user-defined settings for **Enabled** and **Locked** are saved as the default settings. No parameter is repressed by default.

Measured parameters	Units	Offset	Slope	Out-of-range suppression
pH	N/A	0.000	1.000	N/A
pCO ₂	mmHg	0.0	1.000	N/A
pO ₂	mmHg	0.0	1.000	N/A
ctHb	g/dL	N/A	1.000	No
sO ₂	%	0.0	1.000	No
FO ₂ Hb	%	N/A	N/A	No
FCOHb	%	0.0	N/A	No
FMetHb	%	0.0	N/A	No
FHHb	%	N/A	N/A	No
FHbF	%	0	1.000	Yes
cK ⁺	mmol/L	0.0	1.000	N/A
cNa ⁺	mmol/L	0	1.000	N/A
cCa ²⁺	mmol/L	0.00	1.000	N/A
cCl ⁻	mmol/L	0	1.000	N/A
cGlu	mmol/L	0.0	1.000	N/A
cLac	mmol/L	0.0	1.000	N/A
ctBil*	µmol/L	0	1.000	N/A

* Bilirubin can only be measured on neonatal samples. This parameter is only available in the Neonate blood analysis 65 µL mode.

Measurement units - default settings

Items	Default setting
Pressure	mmHg

Items	Default setting
ctBil*	μmol/L
ctHb	g/dL
FCO ₂ Hb	%
FHbF	%
FHHb	%
FMetHb	%
FO ₂ Hb	%
sO ₂	%
Gas fractions	%
FO ₂ (I)	%
Hct	%
pO ₂ (a,A)	%
FShunt	%
RI	%
cK ⁺ /cNa ⁺ / cCl ⁻	mmol/L
cCa ²⁺	mmol/L
cGlu	mmol/L
cLac	mmol/L
Temperature	°C
ctO ₂	Vol %
ctCO ₂	Vol %
$\dot{D}O_2$	mL/min
$\dot{V}O_2$	mL/min
Age	years
Weight	kg
Height	m
Altitude	m
Birth weight	g

* Bilirubin can only be measured on neonatal samples. This parameter is only available in the Neonate blood analysis 65 μL mode.

Calibration schedule - default settings

Calibration schedule setup	Default setting
tHb calibration	Interval: 3 months
First calibration starts at:	00:00
Link QC schedule with calibration schedule:	Yes

Quality control setups - default settings

Setups	Item	Default setting
QC statistics	Statistical factor used for value acceptance:	1.5
	Automatically print QC statistics when lot changes:	Yes
QC input setup	Mandatory temperature:	No
	Default temperature:	25 °C
QC schedule	Built-in QC solutions (S9030, S9040, S9050)	04:00, 12:00, 20:00 (daily)
	Run built-in QCs after replacement and startup	Yes
Westgard rules	Use Westgard Evaluation:	No
RiLiBÄK rules	Use RiLiBÄK rules	No

Replacement setups - default settings

Menu	Item	Default setting - interval
Replacement schedule setup	Inlet Gasket	Never
	Inlet Probe	Never
	Connection gasket	Never
	Clean inlet	Never
Operator activity schedule	None	-
Maintenance planning setup	None	-
Replacement warning setup	Number of activities before replacement warning:	5
	Time before replacement warning:	4 hours
	Expected measurements per day:	10

Note: - = There is no default setting.

Communication setup - default settings

Item	Default settings
RADIANCE connection	Not enabled
LIS/HIS connection	-
QA portal	Not enabled
Automatic data request	-
Automatic data transmission	-
Patient lookup setup	On the D:\ drive of the analyzer (local database)
Remote support	Enable remote access: Yes

Note: - = There is no default setting.

User-defined patient data items - default settings

Note: All items have numerical values.

Item	Unit	Number of decimals
Spontaneous RR	b/min	1
Set RR	b/min	2
Vt	L	2
Ve	L	2
Peak flow	L/min	1
Liter flow	L/min	2
Ti	seconds	1
PEEP	cmH ₂ O	1
Pressure support	cmH ₂ O	1
CPAP	cmH ₂ O	1
CMV	Rate	1
SIMV	Rate	1
Flow-by	L/min	1
HFV	Rate	1
I:E ratio	-	2
Wave	-	-
ICD9 code	-	-
Oxygen device 1	-	-
Oxygen device 2	-	-
Diagnostic code	-	-

Note: – = There is no default setting.

Corrective actions – default settings

Event	Default setting	Traffic light color
Calibration error(s) present	Do not run scheduled built-in QC	Yellow
Calibration schedule reminder(s)	–	Yellow
QC error(s) present	? on specific parameters	Yellow
QC schedule reminder(s)	–	Yellow
Replacement schedule reminder(s)	–	Yellow
System message(s) present	–	Yellow
Operator activity reminder(s)	–	Yellow
Built-in QC error(s) present	–	Yellow

Note: – = There is no default setting.

Miscellaneous setup - default settings

Item	Default setting
Analyzer locked	Not enabled
Enable estimated derived parameters	Not enabled
Fixed pO_2/pCO_2 decimals	Not enabled
Enable general barcode support	Enabled
Enable patient result approval	Not enabled
Apply parameter corrections to QC	Enabled
Log all measurement activities	Not enabled
Auto temp unit conversion	Not enabled
Enable screen saver	Enabled
Show parameter bar	Enabled
HbF correction	Enabled for levels > 20 %
Analyzer message	–
Enable screen saver (the time period the analyzer must not be in use before the screen saver is shown)	5 minutes

Printer setup - default settings

Item	Default setting
Installed printers	The analyzer printer
Manual printing (to see and select a printer from a list of the installed printers)	Off

Automatic printing - default settings

Item	Default settings
Patient results	On
QC results	Off
Calibration results	Off
Activity log messages	Off
Message level	User
Number of copies (to print)	1

Automatic archiving - default settings

Item	Default setting
Patient results log	On
Calibration log	On
Quality control log	On
Activity log	On
Store archives on the analyzer	On

Automatic backup - default setting

Item	Default setting
Automatic backup	Off

Setups with no default settings

- User-defined notes
- Barometer setup
- Time and date setup
- Analyzer identification setup

References

1. Tietz, NW, Logan NM. Reference ranges, In: Tietz NW, ed. Fundamentals of clinical chemistry: 3rd ed. Philadelphia: WB Saunders Company, 1987: 944-75.
2. Westgard JO, Barry PLL. Cost effective quality control: managing the quality and productivity of analytical processes. Washington: AACC Press, 1992.

Performance characteristics 10

Measured parameters - definitions

Measured parameters are parameters measured by the analyzer. Parameter definitions are shown in the table.

Measured parameters	Definition
pH	Is a measure of the acidity or alkalinity of a sample
cH ⁺	Concentration of hydrogen ions in blood
pCO ₂	Partial pressure (or tension) of carbon dioxide in blood
pO ₂	Partial pressure (or tension) of oxygen in blood
ctHb	Concentration of total hemoglobin in blood
sO ₂	Oxygen saturation, the ratio between the concentrations of oxyhemoglobin and the hemoglobin minus the dyshemoglobins
FO ₂ Hb	Fraction of oxyhemoglobin in total hemoglobin in blood
FCOHb	Fraction of carboxyhemoglobin in total hemoglobin in blood
FMetHb	Fraction of methemoglobin in total hemoglobin in blood
FHHb	Fraction of deoxyhemoglobin in total hemoglobin in blood
FHbF	Fraction of fetal hemoglobin in total hemoglobin in blood
cK ⁺	Concentration of potassium ions in plasma
cNa ⁺	Concentration of sodium ions in plasma
cCa ²⁺	Concentration of calcium ions in plasma
cCl ⁻	Concentration of chloride ions in plasma
cGlu	Concentration of D-glucose in plasma
cLac	Concentration of L-lactate in plasma
ctBil	Concentration of total neonatal bilirubin in plasma. Bilirubin can only be measured on neonatal samples. This parameter is only available in the Neonate blood analysis 65 µL mode.

About performance characteristics

Overview of performance characteristics

The performance characteristics for parameters measured on the analyzer are based on the results of performance tests [1]. A comparison is made between the ABL90 FLEX analyzer and the primary reference methods, as well as between the ABL90 FLEX analyzer and the reference analyzer (the ABL735 analyzer).

The performance characteristics shown in the table below were calculated from the results.

Performance characteristics	Definitions
Bias _{Prim.ref}	The mean difference between results obtained on the ABL90 FLEX analyzer and those obtained with primary reference methods
Bias _{Sec.ref}	The mean difference between results obtained on the ABL90 FLEX analyzer and the ABL735 analyzer
S ₀	Repeatability (precision estimate)
S _x	Reproducibility (precision estimate)
CV %	Coefficient of variation
TE _A	Total analytical error

Uncertainty in performance characteristics

Performance characteristics of the analyzer are calculated from the results of performance tests. The results are subject to an uncertainty due to test conditions during the performance tests. Uncertainty values as well as exact values are therefore given for bias, S₀, S_x and TE_A characteristics.

Performance characteristics	Assumptions made in the calculation of uncertainty
Bias	Bias values are described by a normal distribution.
S ₀	S ₀ ² and S _x ² , calculated from S ₀ and S _x values, is described by a Chi-square distribution
S _x	
TE _A	TE _A is calculated from the bias and S _x

The given uncertainty values are calculated at a confidence interval of 68 %.

An uncertainty at a 68 % confidence interval, which corresponds to 1 SD, can be converted into an uncertainty at other confidence intervals.

For bias, the uncertainty value at a 68 % confidence interval is given as a plus-minus value (for example ±x.xxx). For S₀, S_x and TE_A the upper limit of the uncertainty values at a 68 % confidence interval are given as plus values (for example +x.xxx).

Related information

To convert an uncertainty at a 68 % confidence level, page 219

To convert an uncertainty at a 68 % confidence level

The table shows the factor you need to multiply uncertainties at a 68 % confidence level with to convert them to uncertainties at a new confidence level.

New confidence level	Multiplication factor
90 %	1.64
95 %	1.96
97.5 %	2.24
99 %	2.58
99.5 %	2.81
99.9 %	3.29

Example:
 Uncertainty_{at a 95 % confidence interval} = Uncertainty_{at a 68 % confidence interval} × 1.96

Bias

The bias of a quantity is defined as the mean difference between the measured value on a group of test instruments and the estimated true value (as assayed by the reference method or certified standard reference material). Bias_{Prim.ref} was determined as follows:

$$\text{Bias}_{\text{Prim.ref}} = \bar{x}_{\text{ABL90 FLEX}} - \bar{x}_{\text{Primary reference method/material}}$$

Bias_{Sec.ref} is a relative bias between the ABL90 FLEX analyzer and the ABL735 analyzer in macromode (C 195µL mode), and was determined as follows:

$$\text{Bias}_{\text{Sec.ref}} = \bar{x}_{\text{ABL90 FLEX}} - \bar{x}_{\text{ABL735}}$$

Bias values given in the performance test results were calculated from performance test results. The uncertainty given with bias test results was calculated a 68 % confidence level.

Note: The assumption was made that bias values are normally distributed.

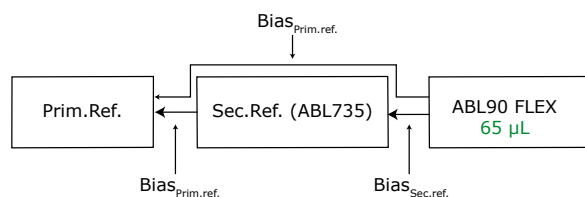

Repeatability and reproducibility

Repeated measurements on one analyzer of samples that are assumed to be identical will not necessarily give identical results. The degree of variation in the results is a measure of the imprecision (under repeatability conditions) of the analyzer [2].

S₀ and S_x values given in the performance test results were calculated from performance test results. The uncertainty given with bias test results was calculated a 68 % confidence level.

Note: The assumption was made that S_0^2 and S_x^2 , calculated from S_0 and S_x values, is described by a Chi-square distribution.

Performance characteristic	Abbreviation	Description
Repeatability	S_0	<p>This is the standard deviation obtained from repeated measurements within a short interval of time with:</p> <ul style="list-style-type: none"> • The same instrument and location • The same measurement procedure • Identical portions of the same sample • One operator per analyzer <p>S_0 for each level is pooled for all test analyzers and test days.</p> <p>The repeatability is equal to S_0.</p>
Reproducibility	S_x	<p>This is the standard deviation obtained from repeated measurements over several days with:</p> <ul style="list-style-type: none"> • Random analyzer • Random sample • Random operators <p>The reproducibility for each level is calculated on the basis of all test analyzers and test days.</p> <p>The reproducibility is equal to S_x.</p>

Coefficient of variation (CV %)

The coefficient of variation is reported as a percentage and calculated from the mean (or measuring level) and standard deviation as follows:

$$CV\% = \frac{\text{Standard deviation}}{\text{Measuring level}} \times 100$$

Confidence intervals

Confidence interval provides a range of values estimated from a study group that is highly likely to include the true, but unknown, value. A confidence interval applies to the results of a statistical analysis. A 95 % confidence interval means that there is only a 5 % chance that the true value is not included in the interval.

Uncertainty values were calculated at a confidence level of 68 % for the bias, S_0 , S_x and TE_A values given in the performance test results.

To calculate the uncertainty values at a confidence level of 95 %, multiply the uncertainty values at a confidence level of 68 % by the factor 1.96.

At a pH level of 6.800, the uncertainty in the bias value at a 68 % confidence level = ± 0.0050 .

At a pH level of 6.800, the uncertainty in the bias value at a 95 % confidence level = $\pm 0.0050 \times 1.96 = \pm 0.0098$.

Total analytical error

TE_A , total analytical error is a quality specification that sets a limit for both the random error (reproducibility) and systematic error (bias) in a single measurement or single test result.

Total analytical error values given in the performance test results were calculated as absolute numbers and percentages.

- The equation: $TE_A = (|Bias| + 1.96 \times S_x)$, was used to calculate the absolute values
- The equation: $TE_A = (|Bias \%| + 1.96 \times CV_x) \%$, was used to calculate the percentage values

The uncertainty given with the TE_A values is calculated from the uncertainty of the bias and S_x values at a 68 % confidence level.

The equation used to calculate TE_A defines a 95 % confidence interval ($0 \pm TE_A$) for the total analytical error, when the TE_A value is corrected with 2 times the uncertainty given with the TE_A value.

About performance tests

Test conditions

Test conditions to determine the performance characteristics for the measured parameters were as follows:

Item	Description
Reference analyzers	Five ABL735 analyzers with AutoCheck module were used as a reference. The capillary mode was used for pCO_2 and pO_2 , and the syringe mode for all the other parameters.
Primary/secondary reference methods	As specified for each parameter in this chapter
Analyzers and test modes	8-10 analyzers were tested in 65 μ L syringe and capillary modes.
Blood samples	Heparinized blood samples from healthy, voluntary donors. The blood was prepared to obtain different concentration levels of each measured parameter.
Blood measurements	Measurements on every parameter were done on all analyzers, with 5 measurements on every sample of each run, repeated for 3 days. The measurements were done by different operators.
Solution Pack	All calibration solutions and gases used for the tests are traceable to Primary Reference Standards. Contact your local Radiometer representative for traceability certificates for the ABL90 FLEX calibration solutions and gases.
Experimental conditions	Ambient temperature: 22-25 °C. Relative humidity: 30-50 %. Barometric pressure: 730-780 mmHg

Note: The solutions used in performance tests are those recommended by Radiometer. Performances using other solutions cannot be guaranteed. The performance tests are done under conditions where the analyzers are not influenced by electromagnetic fields.

Reference methods/materials

Parameter	Primary reference method/material	Secondary reference method	Reference
pH	Capillary-type glass pH electrode with a saturated calomel reference electrode and a liquid junction saturated with KCl (BMS Mk2). The calibration standards are traceable to the Primary Reference Standards for pH.	ABL735 analyzer	[3,4]
pCO ₂	Tonometry. The gases used for tonometry are traceable to NIST-certified Standard Reference Materials.	N/A	[5]
pO ₂	Tonometry. The gases used for tonometry are traceable to NIST-certified Standard Reference Materials.	N/A	[5]
cCa ²⁺	Calcium transfer standards were used. These are traceable to NIST SRM 915b and SRM 956b and have an ionic strength of 160.0 mmol per kg of water and pH 7.40 at 37 °C, where 1 mmol/L (37 °C) HEPES buffer was used.	ABL735 analyzer	The standards were produced as indicated in [6]
cCl ⁻	NIST-certified Standard Reference Material SRM 909b human serum) and SRM 956b	ABL735 analyzer	
cK ⁺	NIST-certified Standard Reference Material SRM 909b human serum) and SRM 956b	ABL735 analyzer	
cNa ⁺	NIST-certified Standard Reference Material SRM 909b human serum), NIST 956b and Radiometer-specified standard serum material (specified using flame photometry)	ABL735 analyzer	
cGlu	Spectrophotometry which uses the hexokinase (HK) method recommended by CLSI (formerly NCCLS), measured on serum	N/A	[7]
cLac	Spectrophotometry which uses a lactate dehydrogenase (LDH) method, measured on serum	N/A	[8]
ctHb	HiCN method recommended by CLSI (formerly NCCLS)	ABL735 analyzer	[9]
sO ₂	Tonometry: 100%: blood is tonometered with a gas mixture which contains 94.4% O ₂ and 5.6% CO ₂ . 0%: blood is tonometered with a gas mixture which contains 94.4% N ₂ and 5.6% CO ₂ + dithionite.	ABL735 analyzer	
FO ₂ Hb	Measured in accordance with the following relation: FO ₂ Hb = 1 - (FHHb + FCOHb + FMetHb)	ABL735 analyzer	
FHHb	0%: blood is tonometered with a gas mixture which contains 94.4 % N ₂ and 5.6 % CO ₂ + dithionite	ABL735 analyzer	
FCOHb	Gas chromatography: The Standards are carbon monoxide mixtures with atmospheric air, whose purity is validated in accordance with NIST SRM 1678c (50 ppm CO in N ₂)	ABL735 analyzer	

Parameter	Primary reference method/material	Secondary reference method	Reference
FMetHb	Spectrometry, modified Evelyn-Malloy method	ABL735 analyzer	[10]
FHbF	The reference method is based on Cation Exchange HPLC	ABL735 analyzer	[11]
ctBil*	The reference method for total bilirubin is a spectrophotometric method (wet chemistry based on a method from Bayer Healthcare, Tarrytown USA). The method is traceable to NIST SRM916a Bilirubin.	ABL735 analyzer	

* Bilirubin can only be measured on neonatal samples. This parameter is only available in the Neonate blood analysis 65 µL mode.

General reference: [25].

Performance test results

Rounding rules

Normal rounding rules are used to round off all the values given in the performance test results tables.

pH performance test results

Bias _{Prim.ref} for pH		
pH	Bias _{Prim.ref}	N (number of samples analyzed)
7.0	-0.0030	45
7.4	0.0020	45
7.6	0.0010	45

$$\text{Bias}_{\text{Prim.ref}} = \text{Bias}_{\text{Sec.ref}} + \text{Bias}_{\text{ABL735-Prim.ref}}$$

65 µL: Performance characteristics for pH – blood samples					
pH	Value and uncertainty	Bias _{Sec.ref}	S ₀	S _x	TE _A
6.800	Value	-0.0300	0.0014	0.0067	0.0431
	Uncertainty	±0.0046	+0.0001	+0.0004	+0.0053
7.000	Value	-0.0120	0.0012	0.0057	0.0232
	Uncertainty	±0.0046	+0.0001	+0.0001	+0.0049
7.200	Value	-0.0090	0.0025	0.0061	0.0210
	Uncertainty	±0.0046	+0.0002	+0.0001	+0.0049
7.400	Value	-0.0030	0.0015	0.0067	0.0162
	Uncertainty	±0.0046	+0.0001	+0.0003	+0.0052
7.800	Value	-0.0040	0.0021	0.0122	0.0278

65 μ L: Performance characteristics for pH – blood samples					
pH	Value and uncertainty	Bias _{Sec.ref}	S ₀	S _x	TE _A
7.800	Uncertainty	± 0.0065	+0.0002	+0.0013	+0.0091

pCO₂ performance test results

65 μ L: Performance characteristics for pCO ₂ – blood samples							
pCO ₂ (mmHg)	Value and uncertainty	Bias _{Prim.ref}	S ₀	S _x	CV _x %	TE _A	TE _A (%)
15.0	Value	0.14	0.16	0.70	4.7	1.52	10.1
	Uncertainty	± 0.14	+0.01	+0.06	-	+0.27	-
40.0	Value	0.18	0.25	0.56	1.4	1.27	3.2
	Uncertainty	± 0.12	+0.02	+0.03	-	+0.18	-
60.0	Value	-0.21	0.29	0.87	1.5	1.92	3.2
	Uncertainty	± 0.22	+0.02	+0.10	-	+0.41	-
80.0	Value	-0.38	0.23	1.45	1.8	3.22	4.0
	Uncertainty	± 0.29	+0.02	+0.18	-	+0.64	-
100	Value	-0.91	0.90	2.38	2.4	5.58	5.6
	Uncertainty	± 0.44	+0.06	+0.22	-	+0.86	-

- = not applicable

pO₂ performance test results

65 μ L: Performance characteristics for pO ₂ - blood samples							
pO ₂ (mmHg)	Value and uncertainty	Bias _{Prim.ref}	S ₀	S _x	CV _x %	TE _A	TE _A (%)
30.0	Value	-0.39	0.35	0.73	2.4	1.8	6.1
	Uncertainty	± 0.15	+0.02	+0.10	-	+0.4	-
75.0	Value	0.47	0.25	0.67	0.9	1.8	2.4
	Uncertainty	± 0.22	+0.02	+0.05	-	+0.3	-
125	Value	0.8	0.5	1.2	1.0	3.2	2.5
	Uncertainty	± 0.4	+0.0	+0.1	-	+0.6	-
250	Value	0.4	1.8	2.9	1.2	6.1	2.5
	Uncertainty	± 0.7	+0.1	+0.2	-	+1.0	-
500	Value	4.9	3.8	6.0	1.2	16.6	3.3
	Uncertainty	± 1.4	+0.2	+0.3	-	+2.0	-

- = not applicable

cK⁺ performance test results

Bias_{Prim.ref} for cK⁺		
cK⁺ (mmol/L / mEq/L)	Bias_{Prim.ref}	N (number of samples analyzed)
2.0	-0.04	45
4.0	0.00	45
6.0	0.01	45

$Bias_{Prim.ref} = Bias_{Sec.ref} + Bias_{ABL735-Prim.ref}$

65 µL: Performance characteristics for cK⁺ - blood samples							
cK⁺ (mmol/L / mEq/L)	Value and uncertainty	Bias_{Sec.ref}	S₀	S_x	CV_x %	TE_A	TE_A(%)
2.0	Value	-0.10	0.04	0.09	4.3	0.27	13.4
	Uncertainty	±0.07	+0.00	+0.00	-	+0.08	-
4.0	Value	-0.01	0.03	0.08	2.0	0.17	4.2
	Uncertainty	±0.07	+0.00	+0.00	-	+0.07	-
6.0	Value	0.04	0.03	0.10	1.7	0.24	4.0
	Uncertainty	±0.08	+0.00	+0.01	-	+0.10	-
8.0	Value	0.07	0.03	0.12	1.5	0.30	3.7
	Uncertainty	±0.09	+0.00	+0.01	-	+0.11	-
10.0	Value	0.10	0.04	0.12	1.2	0.34	3.4
	Uncertainty	±0.09	+0.00	+0.01	-	+0.11	-

- = not applicable

cNa⁺ performance test results

65 µL: Performance characteristics for cNa⁺ - blood samples							
cNa⁺ (mmol/L / mEq/L)	Value and uncertainty	Bias_{Prim.ref}[*]	S₀	S_x	CV_x %	TE_A	TE_A(%)
120	Value	0.5	0.3	1.0	0.8	2.4	2.0
	Uncertainty	±0.8	+0.0	+0.1	-	+0.9	-
130	Value	0.8	0.3	1.1	0.8	2.9	2.2
	Uncertainty	±0.8	+0.0	+0.1	-	+1.0	-
140	Value	0.6	0.3	1.1	0.8	2.7	1.9
	Uncertainty	±0.8	+0.0	+0.1	-	+1.0	-
160	Value	1.0	0.4	1.2	0.7	3.3	2.0
	Uncertainty	±0.9	+0.0	+0.0	-	+1.0	-
180	Value	0.7	0.4	1.4	0.8	3.5	1.9

65 µL: Performance characteristics for cNa ⁺ - blood samples							
cNa ⁺ (mmol/L / mEq/L)	Value and uncertainty	Bias _{Prim.ref} *	S ₀	S _x	CV _x %	TE _A	TE _A (%)
180	Uncertainty	±1.0	+0.0	+0.1	-	+1.2	-

* The ABL735 measurements are corrected to the primary reference method through this equation: $\text{Na}_{\text{ABL735, corrected}} = 1.055 \times \text{Na}_{\text{ABL735, measured}} - 6.8966$ (mmol/L)

- = not applicable

Related information

Reference methods/materials, page 222

cCl⁻ performance test results

Bias _{Prim.ref} for cCl ⁻		
cCl ⁻ (mmol/L / mEq/L)	Bias _{Prim.ref}	N (number of samples analyzed)
89	-1.5	45
119	2.1	45

$$\text{Bias}_{\text{Prim.ref}} = \text{Bias}_{\text{Sec.ref}} + \text{Bias}_{\text{ABL735-Prim.ref}}$$

65 µL: Performance characteristics for cCl ⁻ - blood samples							
cCl ⁻ (mmol/L / mEq/L)	Value and uncertainty	Bias _{Sec.ref}	S ₀	S _x	CV _x %	TE _A	TE _A (%)
80	Value	-1.1	0.3	1.0	1.2	3.1	3.8
	Uncertainty	±0.7	+0.0	+0.1	-	+0.8	-
100	Value	-1.1	0.3	1.2	1.2	3.5	3.4
	Uncertainty	±0.8	+0.0	+0.0	-	+0.9	-
120	Value	-1.4	0.3	1.4	1.2	4.2	3.5
	Uncertainty	±0.9	+0.0	+0.0	-	+1.0	-
140	Value	-1.4	0.3	2.2	1.6	5.7	4.1
	Uncertainty	±1.0	+0.0	+0.2	-	+1.4	-
150	Value	-1.4	0.4	2.1	1.4	5.5	3.7
	Uncertainty	±1.1	+0.0	+0.0	-	+1.2	-

- = not applicable

cCa²⁺ performance test results

Bias _{Prim.ref} for cCa ²⁺		
cCa ²⁺ (mg/dL)	Bias _{Prim.ref}	N (number of samples analyzed)
1.98	0.060	45
4.93	0.144	45

Bias_{Prim.ref} for cCa²⁺		
cCa²⁺ (mg/dL)	Bias_{Prim.ref}	N (number of samples analyzed)
10.02	-0.100	45

$$\text{Bias}_{\text{Prim.ref}} = \text{Bias}_{\text{Sec.ref}} + \text{Bias}_{\text{ABL735-Prim.ref}}$$

65 µL: Performance characteristics for cCa²⁺ - blood samples							
cCa²⁺ (mg/dL)	Value and uncertainty	Bias_{Sec.ref}	S₀	S_x	CV_x %	TE_A	TE_A(%)
2.00	Value	-0.184	0.006	0.073	3.6	0.327	16.3
	Uncertainty	±0.032	+0.000	+0.008	-	+0.048	-
3.00	Value	-0.080	0.007	0.082	2.7	0.241	8.0
	Uncertainty	±0.032	+0.000	+0.010	-	+0.052	-
5.00	Value	0.004	0.012	0.073	1.5	0.148	3.0
	Uncertainty	±0.032	+0.001	+0.005	-	+0.043	-
7.00	Value	0.048	0.019	0.101	1.4	0.246	3.5
	Uncertainty	±0.064	+0.001	+0.002	-	+0.068	-
10.00	Value	-0.152	0.034	0.187	1.9	0.519	5.2
	Uncertainty	±0.140	+0.002	+0.002	-	+0.143	-

- = not applicable

cGlu performance test results

65 µL: Performance characteristics for cGlu in blood with a pO₂ ≥90 mmHg							
cGlu (mg/dL)	Value and uncertainty	Bias_{Prim.ref}	S₀	S_x	CV_x %	TE_A	TE_A(%)
5	Value	0.6	0.4	1.5	30.5	3.5	70.8
	Uncertainty	±1.1	+0.4	+0.2	-	+1.4	-
36	Value	-1.6	0.5	1.7	4.6	4.9	13.6
	Uncertainty	±1.1	+0.6	+0.1	-	+1.4	-
108	Value	-1.3	1.1	2.9	2.7	7.0	6.5
	Uncertainty	±1.1	+1.4	+0.3	-	+1.7	-
180	Value	4.1	1.6	4.2	2.4	12.5	6.9
	Uncertainty	±1.1	+2.0	+0.5	-	+2.2	-
450	Value	-15.7	3.3	14.9	3.3	44.9	10.0
	Uncertainty	±3.3	+3.9	+2.2	-	+7.6	-
720	Value	-28.5	9.4	41.9	5.8	110.6	15.4
	Uncertainty	±9.2	+11.3	+8.7	-	+26.2	-

- = not applicable

65 µL: Performance characteristics for cGlu in blood with 25 mmHg ≤ pO₂ < 90 mmHg							
cGlu (mg/dL)	Value and uncertainty	Bias_{Prim.ref}	S₀	S_x	CV_x %	TE_A	TE_A(%)
5	Value	-0.08	0.4	2.0	39.5	4.6	92.4
	Uncertainty	±1.1	+0.4	+0.4	-	+1.9	-
36	Value	2.5	0.4	1.7	4.8	5.9	16.3
	Uncertainty	±1.1	+0.5	+0.1	-	+1.4	-
108	Value	3.9	0.9	4.0	3.7	11.7	10.8
	Uncertainty	±1.5	+1.1	+0.2	-	+1.8	-
180	Value	4.8	1.8	7.4	4.1	19.3	10.7
	Uncertainty	±2.1	+2.2	+0.6	-	+3.3	-
450	Value	-6.4	4.5	24.8	5.5	55.0	12.2
	Uncertainty	±6.7	+5.4	+2.4	-	+11.5	-
720	Value	-47.5	13.3	56.8	7.9	158.8	22.1
	Uncertainty	±14.5	+16.1	+8.1	-	+30.3	-

- = not applicable

65 µL: Performance characteristics for cGlu in blood with 10 mmHg < pO₂ < 25 mmHg							
cGlu (mg/dL)	Value and uncertainty	Bias_{Prim.ref}	S₀	S_x	CV_x %	TE_A	TE_A(%)
9	Value	-1.1	0.3	1.3	14.0	3.5	39.4
	Uncertainty	±1.1	+0.4	+0.0	-	+1.2	-
36	Value	-1.4	0.5	2.1	5.8	5.5	15.4
	Uncertainty	±1.1	+0.6	+0.2	-	+1.6	-
108	Value	2.9	1.5	5.0	4.6	12.7	11.7
	Uncertainty	±1.2	+1.8	+1.0	-	+3.1	-
180	Value	2.2	2.5	7.4	4.1	16.6	9.2
	Uncertainty	±1.8	+3.0	+0.8	-	+3.4	-
270	Value	-17.7	3.6	15.9	5.9	48.9	18.1
	Uncertainty	±3.2	+4.3	+3.0	-	+9.2	-

- = not applicable

pO₂ levels - how they affect cGlu results

⚠ WARNING – Risk of incorrect results

Low pO₂ levels can have an effect on the linearity of glucose measurements. This can lead to incorrect low glucose results. Please note that cGlu linearity is not specified when the pO₂ level is less than 10 mmHg (1.3 kPa).

pO ₂ levels in a sample		cGlu linearity is specified in the range
mmHg	kPa	
<10	<1.3	Linearity not specified. The cGlu value is not usable. If pO ₂ <10 mmHg (<1.3 kPa), the cGlu value is not usable and no value is shown. Analyzer message no. 1387 "Glu not usable" tells you that the cGlu value is not usable.
10 ≤ pO ₂ <25	1.3 ≤ pO ₂ <3.3	The cGlu value is shown if the cGlu value is <15 mmol/L (<270 mg/dL). If the cGlu value is >15 mmol/L (>270 mg/dL), the cGlu value is shown as ">15" and analyzer message no. 1402 tells you that the cGlu linearity is out of range.
≥25	≥3.3	The entire reportable range.

cLac performance test results

65 µL: Performance characteristics for cLac in blood with a pO ₂ ≥90 mmHg							
cLac (mg/dL)	Value and uncertainty	Bias _{Prim.ref}	S ₀	S _x	CV _x %	TE _A	TE _A (%)
3	Value	0.3	0.3	0.8	25.7	1.8	59.3
	Uncertainty	±0.5	+0.0	+0.1	-	+0.7	-
9	Value	0.3	0.5	1.2	12.9	2.5	28.3
	Uncertainty	±0.6	+0.0	+0.2	-	+0.9	-
45	Value	0.8	0.7	2.0	5.8	4.8	13.8
	Uncertainty	±0.6	+0.1	+0.4	-	+1.4	-
90	Value	1.7	1.0	6.9	7.7	15.3	17.0
	Uncertainty	±1.1	+0.1	+2.0	-	+4.9	-
135	Value	2.6	1.0	8.3	6.1	18.8	13.9
	Uncertainty	±3.1	+0.1	+1.6	-	+6.2	-
225	Value	0.5	2.2	20.9	9.3	41.5	18.4
	Uncertainty	±5.8	+0.2	+4.5	-	+14.7	-

- = not applicable

65 µL: Performance characteristics for cLac in blood with a pO ₂ <90 mmHg							
cLac (mg/dL)	Value and uncertainty	Bias _{Prim.ref}	S ₀	S _x	CV _x %	TE _A	TE _A (%)
3	Value	0.3	0.3	0.8	25.7	1.8	59.3
	Uncertainty	±0.5	+0.0	+0.1	-	+0.7	-
9	Value	0.3	0.4	0.9	9.5	2.0	21.7
	Uncertainty	±0.6	+0.0	+0.1	-	+0.7	-
45	Value	0.8	0.9	3.0	8.5	6.7	19.0
	Uncertainty	±0.6	+0.1	+0.7	-	+2.0	-
90	Value	-0.5	0.8	7.1	7.9	14.3	15.9
	Uncertainty	±1.5	+0.1	+1.7	-	+4.8	-
135	Value	-0.1	0.9	10.5	8.0	20.7	15.3
	Uncertainty	±3.3	+0.1	+2.1	-	+7.5	-
225	Value	-11.4	1.9	24.3	10.8	59.1	26.3
	Uncertainty	±7.3	+0.2	+4.0	-	+15.2	-

- = not applicable

ctHb performance test results

Setup: Adult blood samples. HbF correction is not enabled.

65 µL: Performance characteristics for ctHb – blood samples								
ctHb (g/dL)	sO ₂ (%)	Value and uncertainty	Bias _{Prim.ref} *	S ₀	S _x	CV _x %	TE _A	TE _A (%)
0.00	Undefined	Value	-0.020	0.010	0.020	-	0.060	-
		Uncertainty	±0.003	+0.001	+0.004	-	+0.010	-
3.5	100	Value	0.02	0.05	0.08	2.4	0.19	5.3
		Uncertainty	±0.04	+0.00	+0.00	-	+0.05	-
7.0	100	Value	0.05	0.09	0.17	2.4	0.37	5.3
		Uncertainty	±0.07	+0.01	+0.01	-	+0.09	-
10.0	100	Value	0.06	0.08	0.20	2.0	0.45	4.5
		Uncertainty	±0.09	+0.01	+0.01	-	+0.12	-
15.0	100	Value	0.06	0.08	0.25	1.6	0.54	3.6
		Uncertainty	±0.12	+0.01	+0.02	-	+0.16	-
20.0	100	Value	0.00	0.09	0.30	1.5	0.58	2.9
		Uncertainty	±0.14	+0.01	+0.02	-	+0.19	-
25.0	100	Value	0.08	0.11	0.37	1.5	0.80	3.2

65 µL: Performance characteristics for ctHb – blood samples								
ctHb (g/dL)	sO ₂ (%)	Value and uncertainty	Bias _{Prim.ref} *	S ₀	S _X	CV _X %	TE _A	TE _A (%)
25.0	100	Uncertainty	±0.18	+0.01	+0.04	-	+0.25	-

* The ABL735 measurements are corrected to the primary reference method through this equation:

$$\text{ABL735 HICN}_{\text{corrected}}: \text{ctHb}_{\text{ABL735, corrected}} = -0.000707 \times (\text{ctHb}_{\text{ABL735, measured}})^2 + 0.9977 \times \text{ctHb}_{\text{ABL735, measured}} \text{ (g/dL)}$$

- = not applicable

Related information

Reference methods/materials, page 222

sO₂ performance test results

Setup: Adult blood samples. HbF correction not enabled.

Bias _{Prim.ref} for sO ₂			
sO ₂ (%)	ctHb (g/dL)	Bias _{Prim.ref}	N (number of samples analyzed)
0.0	15	0.07	150
100.0	15	0.23	150
100.0	7	0.46	150
100.0	25	0.00	148

$$\text{Bias}_{\text{Prim.ref}} = \text{Bias}_{\text{Sec.ref}} + \text{Bias}_{\text{ABL735-Prim.ref}}$$

65 µL: Performance characteristics for sO ₂ – blood samples								
sO ₂ (%)	ctHb (g/dL)	Value and uncertainty	Bias _{Sec.ref}	S ₀	S _X	CV _X %	TE _A	TE _A (%)
0.0	15	Value	0.09	0.08	0.26	-	0.59	-
		Uncertainty	±0.20	+0.01	+0.01	-	+0.23	-
50.0	15	Value	-0.26	0.24	0.40	0.8	1.05	2.1
		Uncertainty	±0.30	+0.02	+0.01	-	+0.32	-
65.0	15	Value	-0.20	0.27	0.46	0.7	1.11	1.7
		Uncertainty	±0.30	+0.02	+0.03	-	+0.37	-
75.0	15	Value	-0.10	0.30	0.48	0.6	1.05	1.4
		Uncertainty	±0.30	+0.02	+0.03	-	+0.35	-
90.0	15	Value	-0.10	0.19	0.36	0.4	0.80	0.9
		Uncertainty	±0.21	+0.01	+0.05	-	+0.30	-
100.0	15	Value	-0.07	0.09	0.29	0.3	0.64	0.6
		Uncertainty	±0.17	+0.01	+0.06	-	+0.28	-

65 µL: Performance characteristics for sO ₂ – blood samples								
sO ₂ (%)	ctHb (g/dL)	Value and uncertainty	Bias _{Sec.ref}	S ₀	S _X	CV _X %	TE _A	TE _A (%)
100.0	7	Value	0.45	0.11	0.37	0.4	1.17	1.2
		Uncertainty	±0.16	+0.01	+0.09	-	+0.33	-
100.0	25	Value	-0.53	0.09	0.28	0.3	1.08	1.1
		Uncertainty	±0.16	+0.01	+0.06	-	+0.27	-

- = not applicable

FO₂Hb performance test results

Setup: Adult blood samples. HbF correction is not enabled.

65 µL: Performance characteristics for FO ₂ Hb – blood samples								
FO ₂ Hb (%)	ctHb (g/dL)	Value and uncertainty	Bias _{Sec.ref}	S ₀	S _X	CV _X %	TE _A	TE _A (%)
0.0	15	Value	0.07	0.08	0.26	-	0.57	-
		Uncertainty	±0.20	+0.01	+0.01	-	+0.23	-
50.0	15	Value	-0.25	0.27	0.58	1.2	1.38	2.8
		Uncertainty	±0.31	+0.02	+0.06	-	+0.42	-
65.0	15	Value	-0.43	0.30	0.48	0.7	1.37	2.1
		Uncertainty	±0.32	+0.02	+0.01	-	+0.35	-
75.0	15	Value	-0.27	0.35	0.55	0.7	1.35	1.8
		Uncertainty	±0.33	+0.02	+0.03	-	+0.40	-
90.0	15	Value	-0.23	0.23	0.40	0.4	1.02	1.1
		Uncertainty	±0.27	+0.02	+0.04	-	+0.33	-
100.0	15	Value	-0.10	0.16	0.38	0.4	0.85	0.9
		Uncertainty	±0.24	+0.01	+0.06	-	+0.35	-
100.0	7	Value	-0.09	0.19	0.48	0.5	1.03	1.0
		Uncertainty	±0.25	+0.01	+0.09	-	+0.43	-
100.0	25	Value	-0.45	0.18	0.53	0.5	1.50	1.5
		Uncertainty	±0.26	+0.01	+0.13	-	+0.52	-

- = not applicable

FCOHb performance test results

Setup: Adult arterial blood samples. HbF correction is not enabled.

Bias_{Prim.ref} for FCOHb			
FCOHb (%)	ctHb (g/dL)	Bias_{Prim.ref}	N (number of samples analyzed)
0.0	15	0.41	45
20.0	15	-0.01	45

$Bias_{Prim.ref} = Bias_{Sec.ref} + Bias_{ABL735-Prim.ref}$

65 µL: Performance characteristics for FCOHb – blood samples								
FCOHb (%)	ctHb (g/dL)	Value and uncertainty	Bias_{Sec.ref}	S₀	S_X	CV_X %	TE_A	TE_A (%)
0.0	15	Value	0.00	0.08	0.24	-	0.46	-
		Uncertainty	±0.16	+0.01	+0.04	-	+0.23	-
5.0	15	Value	0.08	0.08	0.26	5.1	0.58	11.7
		Uncertainty	±0.20	+0.01	+0.03	-	+0.26	-
10.0	15	Value	0.04	0.07	0.34	3.4	0.71	7.1
		Uncertainty	±0.30	+0.00	+0.02	-	+0.35	-
20.0	15	Value	0.11	0.08	0.67	3.4	1.43	7.1
		Uncertainty	±0.65	+0.01	+0.01	-	+0.67	-
30.0	15	Value	0.17	0.08	0.68	2.3	1.50	5.0
		Uncertainty	±0.65	+0.01	+0.02	-	+0.69	-
50.0	15	Value	0.30	0.09	0.68	1.4	1.63	3.3
		Uncertainty	±0.65	+0.01	+0.01	-	+0.68	-
99.0	15	Value	0.54	0.12	0.72	0.7	1.96	2.0
		Uncertainty	±0.66	+0.01	+0.04	-	+0.74	-

- = not applicable

FMetHb performance test results

Setup: Adult blood samples. HbF correction is not enabled.

Bias_{Prim.ref} for FMetHb			
FMetHb (%)	ctHb (g/dL)	Bias_{Prim.ref}	N (number of samples analyzed)
0.0	15	0.23	45
20.0	15	-0.13	45

$Bias_{Prim.ref} = Bias_{Sec.ref} + Bias_{ABL735-Prim.ref}$

65 µL: Performance characteristics for FMetHb – blood samples								
FMetHb (%)	ctHb (g/dL)	Value and uncertainty	Bias_{Sec.ref}	S₀	S_X	CV_X %	TE_A	TE_A (%)
0.0	15	Value	-0.04	0.10	0.23	-	0.50	-

65 µL: Performance characteristics for FMetHb – blood samples								
FMetHb (%)	ctHb (g/dL)	Value and uncertainty	Bias _{Sec.ref}	S ₀	S _X	CV _X %	TE _A	TE _A (%)
0.0	15	Uncertainty	±0.11	+0.01	+0.05	-	+0.20	-
5.0	15	Value	0.02	0.09	0.26	5.1	0.52	10.4
		Uncertainty	±0.16	+0.01	+0.04	-	+0.23	-
10.0	15	Value	-0.04	0.12	0.34	3.4	0.70	7.0
		Uncertainty	±0.15	+0.01	+0.07	-	+0.29	-
20.0	15	Value	-0.18	0.09	0.27	1.4	0.72	3.6
		Uncertainty	±0.20	+0.01	+0.03	-	+0.26	-
30.0	15	Value	-0.26	0.09	0.34	1.1	0.92	3.1
		Uncertainty	±0.30	+0.01	+0.01	-	+0.33	-
50.0	15	Value	-0.21	0.09	0.43	0.9	1.05	2.1
		Uncertainty	±0.40	+0.01	+0.01	-	+0.42	-
99.0	15	Value	0.11	0.06	0.62	0.6	1.32	1.3
		Uncertainty	±0.60	+0.00	+0.01	-	+0.62	-

- = not applicable

FHHb performance test results

Setup: Adult blood samples. HbF correction is not enabled.

65 µL: Performance characteristics for FHHb – blood samples								
FHHb (%)	ctHb (g/dL)	Value and uncertainty	Bias _{Sec.ref}	S ₀	S _X	CV _X %	TE _A	TE _A (%)
0.0	15	Value	0.07	0.10	0.28	-	0.61	-
		Uncertainty	±0.17	+0.01	+0.05	-	+0.27	-
10.0	15	Value	0.08	0.18	0.36	3.6	0.78	7.8
		Uncertainty	±0.21	+0.01	+0.05	-	+0.31	-
25.0	15	Value	0.05	0.30	0.48	1.9	1.00	4.0
		Uncertainty	±0.30	+0.02	+0.03	-	+0.35	-
35.0	15	Value	0.08	0.27	0.50	1.4	1.06	3.0
		Uncertainty	±0.31	+0.02	+0.05	-	+0.40	-
50.0	15	Value	0.11	0.26	0.57	1.1	1.23	2.5
		Uncertainty	±0.31	+0.02	+0.05	-	+0.42	-
100.0	15	Value	-0.14	0.16	0.40	0.4	0.92	0.9
		Uncertainty	±0.27	+0.01	+0.03	-	+0.34	-

65 µL: Performance characteristics for FHHb – blood samples								
FHHb (%)	ctHb (g/dL)	Value and uncertainty	Bias _{Sec.ref}	S ₀	S _X	CV _X %	TE _A	TE _A (%)
0.0	7	Value	-0.45	0.13	0.36	-	1.16	-
		Uncertainty	±0.16	+0.01	+0.08	-	+0.32	-
0.0	25	Value	0.53	0.09	0.26	-	1.04	-
		Uncertainty	±0.16	+0.01	+0.05	-	+0.25	-

- = not applicable

FHbF performance test results

Setup: Mixed adult and fetal blood samples. HbF correction enabled for all levels.

65 µL: Performance characteristics for FHbF - blood samples								
FHbF (%)	ctHb (g/dL)	Value and uncertainty	Bias _{Prim.ref}	S ₀	S _X	CV _X %	TE _A	TE _A (%)
20	15	Value	1.1	1.8	3.6	18.0	8.2	40.8
		Uncertainty	±0.8	+0.1	+0.6	-	+2.0	-
30	15	Value	-1.7	1.8	4.3	14.2	10.0	33.5
		Uncertainty	±1.2	+0.1	+1.0	-	+3.1	-
50	15	Value	-3.1	1.6	3.9	7.8	10.7	21.5
		Uncertainty	±1.8	+0.1	+0.6	-	+2.7	-
80	15	Value	-4.2	1.8	4.1	5.1	12.2	15.2
		Uncertainty	±2.8	+0.1	+0.3	-	+3.3	-

The ABL735 measurements are corrected to the primary reference method through this equation:

$$FHbF_{ABL735, corrected} = FHbF_{ABL735, measured} - 0.9 \times ctHb + 11.7 (\%)$$

- = not applicable

Related information

Reference methods/materials, page 222

ctBil* performance test results

Setup: HbF correction is enabled for all levels.

ctBil* (mg/dL)	ctHb (g/dL)	Value and uncertainty	Bias _{Sec.ref}	S ₀	S _X	CV _X %	TE _A	TE _A (%)
2.0	18	Value	-0.44	0.16	0.55	27.0	1.51	75.0
		Uncertainty	±0.16	0.01	0.16	-	0.47	-
5.8	18	Value	-0.39	0.19	0.59	10.2	1.54	26.4
		Uncertainty	±0.23	0.01	0.15	-	0.52	-

ctBil* (mg/dL)	ctHb (g/dL)	Value and uncertainty	Bias _{Sec.ref}	S ₀	S _X	CV _X %	TE _A	TE _A (%)
11.7	18	Value	- 0.57	0.20	0.69	5.9	1.93	16.5
		Uncertainty	±0.36	0.01	0.16	-	0.68	-
23.4	18	Value	- 0.89	0.30	0.95	4.1	2.75	11.7
		Uncertainty	±0.50	0.02	0.18	-	0.86	-
35.1	18	Value	- 0.84	0.36	1.23	3.5	3.26	9.3
		Uncertainty	±0.73	0.02	0.23	-	1.19	-

* Bilirubin can only be measured on neonatal samples. This parameter is only available in the Neonate blood analysis 65 µL mode.

NOTES: a. Umbilical cord blood, pH = 7.4 ± 0.1. Spiked with unconjugated bilirubin.

Linearity study - study design

Linearity study

The linearity study was done according to NCCLS "Evaluation of the Linearity of Quantitative Measurement Procedures: A Statistical Approach; Approved Guideline. NCCLS document EP6, 2003".

Tests on each parameter were done with one analyzer, for one day, on a minimum of 7 levels (except for calcium, where only 6 levels were available) and 2 replicates per level were done.

The study was an in-house study. Test material was:

- whole blood for pH, blood gases, electrolytes except calcium and co-oximetry parameters
- cord blood, adjusted to mimic neonatal blood for ctBil* (ctHb~18 g/dL;~100 % sO₂).
- standards for calcium
- serum pools for glucose and lactate

Where whole blood was used as test material, the true values of the test material were established according to the reference methods shown in this manual.

*Bilirubin can only be measured on neonatal samples. This parameter is only available in the Neonate blood analysis 65 µL mode.

Linearity study - results

For each parameter the ABL90 FLEX results were analyzed for linearity.

For all parameters first, second and third order behaviour was investigated. Where significant, second and/or third order behaviour was seen, linearity was verified to be within pre-established limits for permitted error because of non-linearity.

Graphical presentation of test results and first order models

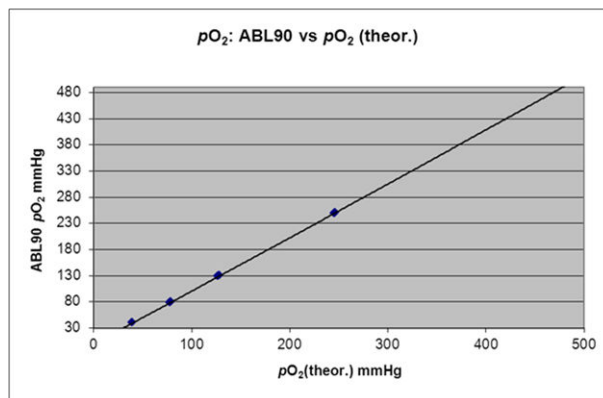
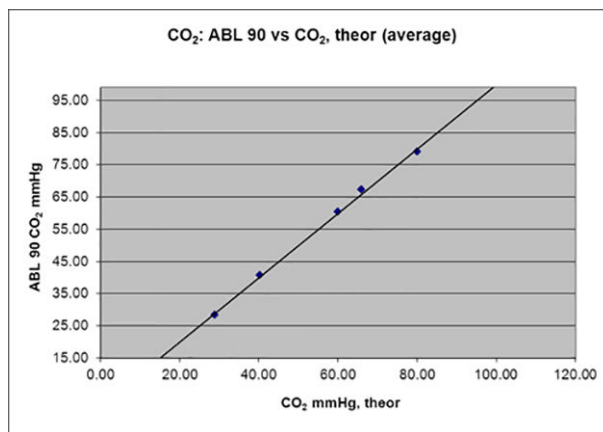
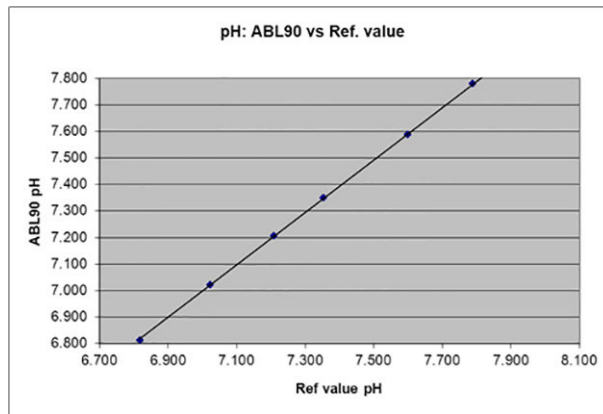

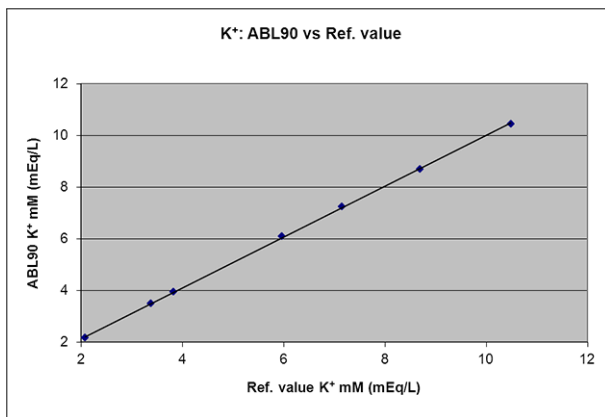
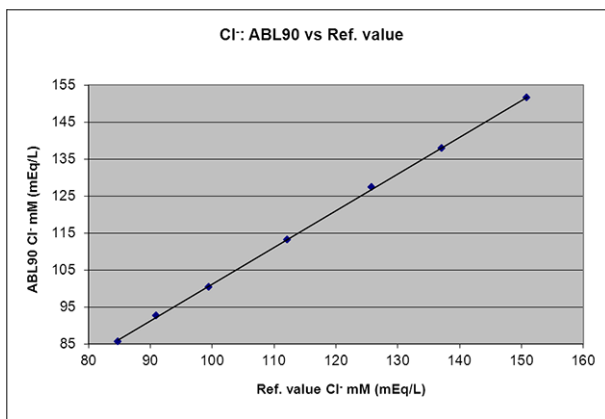
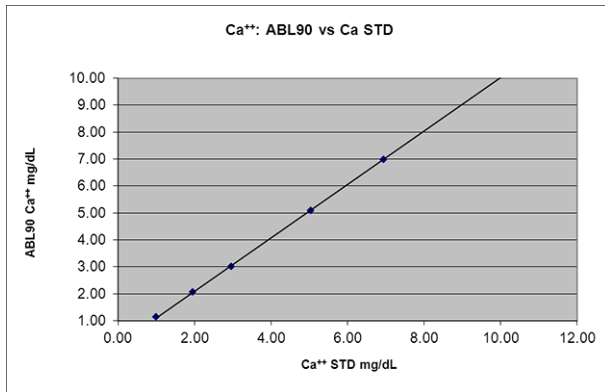

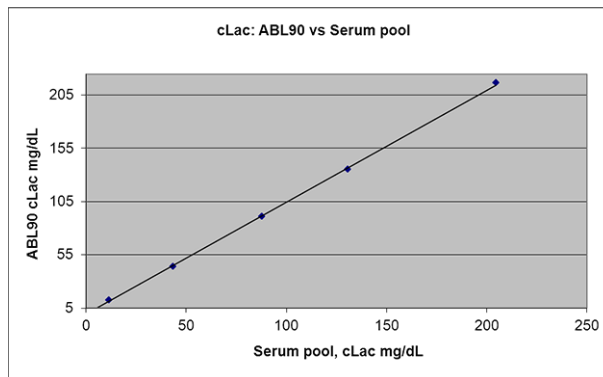
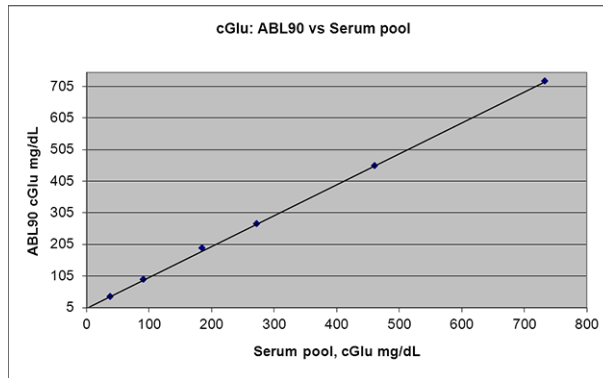
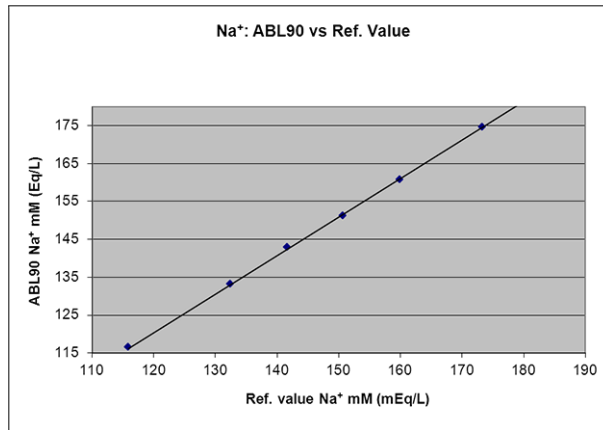

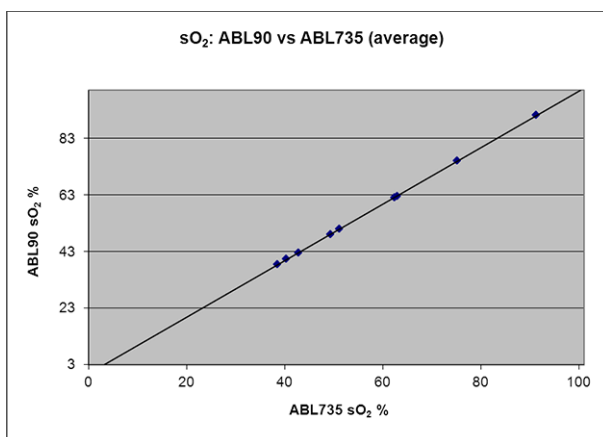
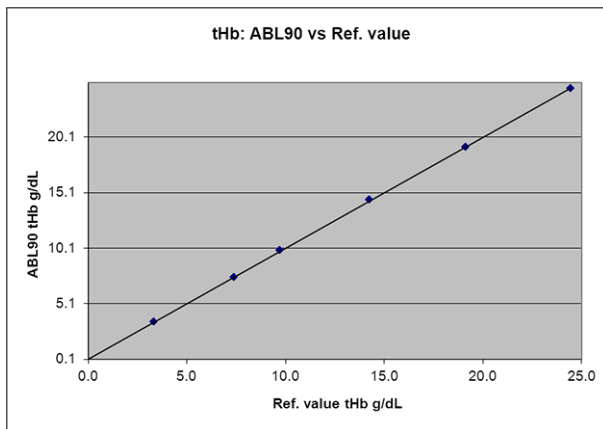
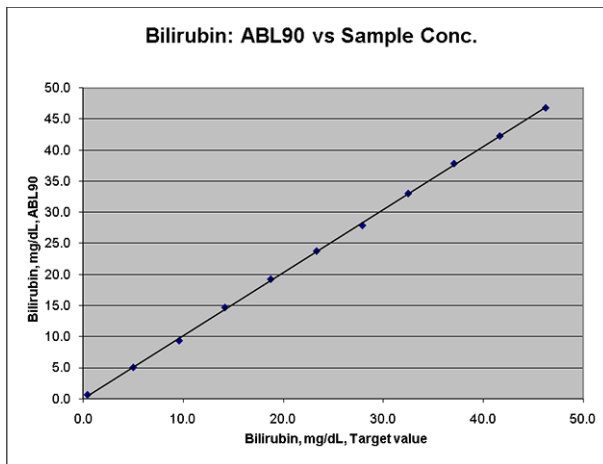

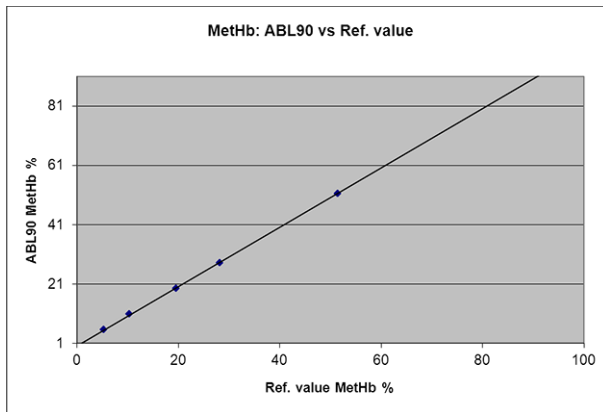
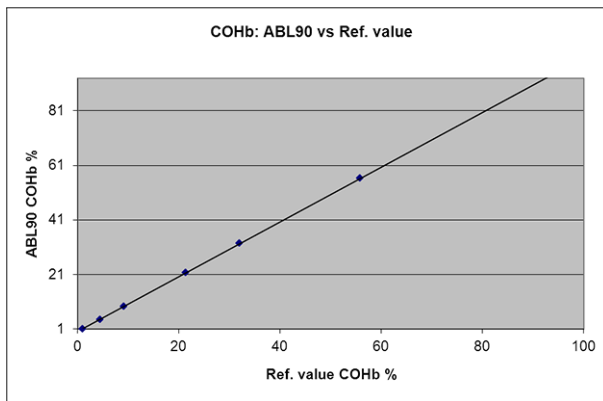
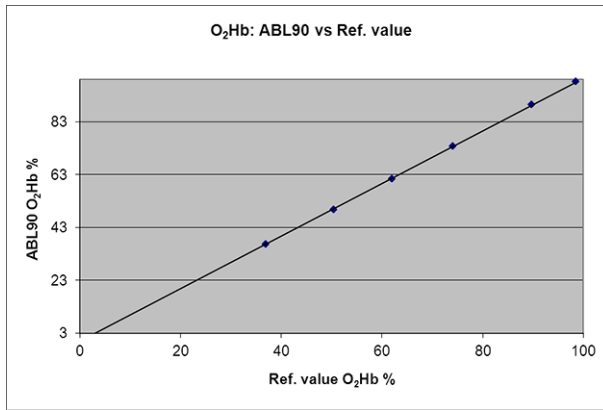

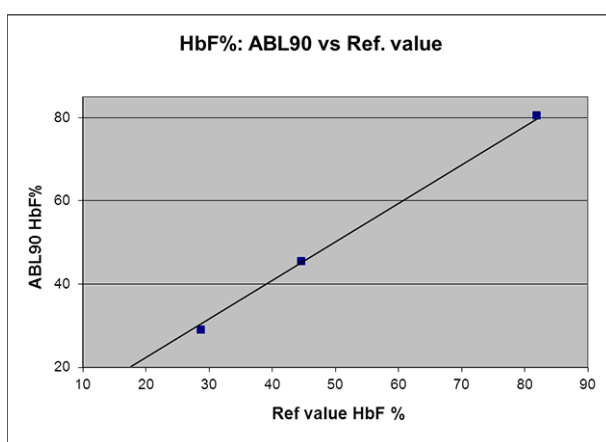
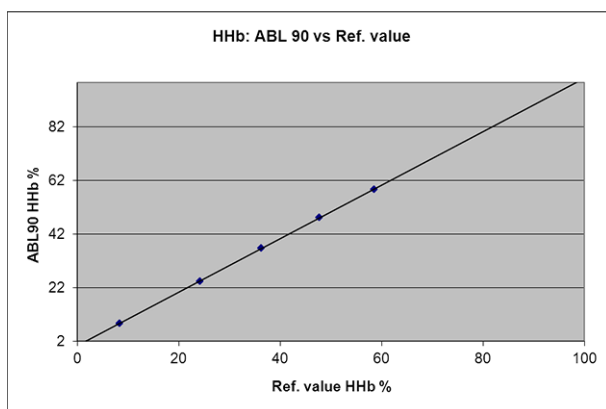

Interference test results

Interference tests

Interfering substances were selected for the interference tests. The selection was based on previous knowledge and where interference was thought to be possible.

Interference can be caused by these factors:

- chemical structure
- decomposition
- optical properties
- other properties that are relevant to take into account as given in [21].

Interference limits were selected for all parameters. The interference limit is the concentration of the interfering substance that was used for the interference tests. The tests used parameters at their normal physiological levels.

To determine the degree of interference, test results for a sample with and without an added interferent were compared. The results from the interference tests are given as the deviation from the correct result [22].

pH/blood gas

These interference results are found for pH and blood gases:

Substance	Test concentration	Interference on ...			Test matrix
		pH (at pH ~ 7.4)	pCO ₂ mmHg (at 30-60 mmHg)	pO ₂ mmHg (at <100 mmHg)	
Ca ²⁺	5.5 mmol/L	< 0.010	N/A	N/A	Blood
	11 mEq/L				
	22 mg/dL				
Fluorescein	400 mg/L	N/A	N/A	< 1	Blood
Hemolysis	2 %	< 0.010	< 0.5	< 1	Blood
	5 %	< 0.010	< 0.5	< 1	Blood
	10 %	< 0.010	< 0.5	< 1	Blood
	20 %	< 0.010	< 0.5	-1.50	Blood
Intralipid	2 % (400 mg/dL)	< 0.010	< 0.5	< 1	Blood/aqueous
	5 % (1000 mg/dL)	< 0.010	< 0.5	< 1	Blood/aqueous
K ⁺	17 mmol/L / mEq/L	< 0.010	N/A	N/A	Blood
Na ⁺	190 mmol/L / mEq/L	< 0.010	N/A	N/A	Blood
Bilirubin (conj)	400 µmol/L	< 0.010	< 0.5	< 1	Blood
	23.4 mg/dL				
Bilirubin (unconj)	500 µmol/L	< 0.010	< 0.5	< 1	Blood
	29.2 mg/dL				

N/A: Interference has not been measured on the respective parameter.

Numbers in brackets, i.e. <|1|: show that the interference lies within a range of ± the number in the brackets, i.e. <|1| = an interference within ±1.

Electrolytes

These interference results are found for the electrolytes:

Substance	Test concentration	Interference on ...				Test matrix
		cK ⁺ (at 4 mEq/L)	cNa ⁺ (at 140 mEq/L)	cCa ²⁺ (at 5 mg/dL)	cCl ⁻ (at 105 mEq/L)	
Acetylsalicylic acid	0.91 mmol/L	N/A	N/A	N/A	< 1	Plasma
	0.16 g/L					
	1.21 mmol/L	N/A	N/A	N/A	< 1	Plasma
	0.22 g/L					

Substance	Test concentration	Interference on ...				Test matrix
		cK ⁺ (at 4 mEq/L)	cNa ⁺ (at 140 mEq/L)	cCa ²⁺ (at 5 mg/dL)	cCl ⁻ (at 105 mEq/L)	
Acetylsalicylic acid	1.81 mmol/L	N/A	N/A	N/A	1.1	Plasma
	0.33 g/L					
	3.62 mmol/L	N/A	N/A	N/A	3.0	Plasma
	0.65 g/L					
Acetyl-tryptophane	0.12 mmol/L	N/A	N/A	N/A	< 1	Plasma
	0.03 g/L					
Ammonium (NH ₄ ⁺)	1 mmol/L (1.7 mg/dL)	< 0.1	< 1	N/A	1.1	Plasma
	107 µmol/L (0.18 mg/dL)	< 0.1	< 1	N/A	< 1	Plasma
Ascorbic acid	170 µmol/L	N/A	N/A	N/A	< 1	Plasma
	0.03 g/L					
	850 µmol/L	N/A	N/A	N/A	< 1	Plasma
	0.15 g/L					
Benzalkonium chloride	7.5 µg/mL	0.27	8.7	0.552	< 1	Plasma
	10 µg/mL	0.39	12.1	0.728	< 1	Plasma
	15 µg/mL	0.60	18.8	1.076	< 1	Plasma
	30 µg/mL	1.28	40.4	2.488	< 1	Plasma
Bilirubin (conj)	400 µmol/L	< 0.1	1.31	< 0.08	< 1	Blood
	23.4 mg/dL					
Bilirubin (unconj)	500 µmol/L	< 0.1	< 1	< 0.08	1.01	Blood
	29.2 mg/dL					
Bromide (Br ⁻)	37.5 mmol/L / mEq/L	N/A	N/A	N/A	76.6	Plasma
	18.75 mmol/L / mEq/L	N/A	N/A	N/A	37.6	Plasma
	10 mmol/L / mEq/L	N/A	N/A	N/A	19.5	Plasma
	5 mmol/L / mEq/L	N/A	N/A	N/A	10.1	Plasma

Substance	Test concentration	Interference on ...				Test matrix
		cK ⁺ (at 4 mEq/L)	cNa ⁺ (at 140 mEq/L)	cCa ²⁺ (at 5 mg/dL)	cCl ⁻ (at 105 mEq/L)	
Bromide (Br ⁻)	1 mmol/L / mEq/L	N/A	N/A	N/A	1.8	Plasma
Calcium (Ca ²⁺)	3.4 mmol/L	< 0.1	1.2	N/A	N/A	Plasma
	6.8 mEq/L					
	13.6 mg/dL					
	2.2 mmol/L	N/A	< 1	N/A	N/A	Plasma
	4.4 mEq/L					
	8.8 mg/dL					
	1.8 mmol/L	N/A	< 1	N/A	N/A	Plasma
	3.6 mEq/L					
	7.2 mg/dL					
	1.6 mmol/L	N/A	< 1	N/A	N/A	Plasma
	3.2 mEq/L					
	6.4 mg/dL					
Caprylic acid	0.12 mmol/L	N/A	N/A	N/A	< 1	Plasma
	0.017 g/L					
Citrate	1 mmol/L	N/A	N/A	N/A	< 1	Plasma
	0.19 g/L					
	40 mmol/L	N/A	N/A	N/A	-4.9	Plasma
	7.7 g/L					
Fluoride (F ⁻)	107 μmol/L / mEq/L	N/A	N/A	N/A	< 1	Plasma
	1 mmol/L / mEq/L					
Hemolysis	2 %	1.32	-2.35	-0.340	1.57	Blood
	5 %	3.63	-5.16	-0.636	2.27	Blood
	10 %	6.77	-8.56	-0.928	1.20	Blood
	20 %	12.68	-15.14	-1.488	< 1	Blood
Intralipid	2 % (400 mg/dL)	< 0.1	< 1	< 0.08	< 1	Plasma
	5 % (1000 mg/dL)	< 0.1	2.4	< 0.08	1.7	Plasma

Substance	Test concentration	Interference on ...				Test matrix
		cK ⁺ (at 4 mEq/L)	cNa ⁺ (at 140 mEq/L)	cCa ²⁺ (at 5 mg/dL)	cCl ⁻ (at 105 mEq/L)	
Iodide (I ⁻)	2.99 mmol/L / mEq/L	N/A	N/A	N/A	12.4	Plasma
	1.5 mmol/L / mEq/L	N/A	N/A	N/A	5.3	Plasma
	1 mmol/L / mEq/L	N/A	N/A	N/A	3.5	Plasma
	0.75 mmol/L / mEq/L	N/A	N/A	N/A	2.5	Plasma
Lactate	25 mmol/L	N/A	N/A	N/A	< 1	Plasma
	225 mg/dL					
Lithium (Li ⁺)	3.2 mmol/L / mEq/L	< 0.1	< 1	< 0.08	N/A	Plasma
Magnesium (Mg ²⁺)	15 mmol/L	N/A	< 1	-0.092	N/A	Aqueous
	30 mEq/L					
	<14 mmol/L	N/A	< 1	< 0.08	N/A	Aqueous
	<28 mEq/L					
Oxalate	1 mmol/L	N/A	N/A	N/A	< 1	Plasma
	0.09 g/L					
	10 mmol/L	N/A	N/A	N/A	< 1	Plasma
	0.9 g/L					
Perchlorate (ClO ₄ ⁻)	0.375 mmol/L / mEq/L	N/A	N/A	N/A	2.1	Plasma
	0.5 mmol/L / mEq/L	N/A	N/A	N/A	2.5	Plasma
	0.75 mmol/L / mEq/L	N/A	N/A	N/A	3.7	Plasma
	1.5 mmol/L / mEq/L	N/A	N/A	< 0.08	7.3	Plasma
pH	6.8-8	N/A	N/A	-0.148 mg/dL / pH	N/A	Aqueous/plasma
		N/A	N/A	N/A	< 1	Plasma

Substance	Test concentration	Interference on ...				Test matrix
		cK ⁺ (at 4 mEq/L)	cNa ⁺ (at 140 mEq/L)	cCa ²⁺ (at 5 mg/dL)	cCl ⁻ (at 105 mEq/L)	
Potassium (K ⁺)	12 mmol/L / mEq/L	N/A	< 1	< 0.08	N/A	Plasma
Salicylic acid	1.09 mmol/L	N/A	N/A	N/A	< 1	Plasma
	0.15 g/L					
	1.45 mmol/L	N/A	N/A	N/A	< 1	Plasma
	0.2 g/L					
	2.17 mmol/L	N/A	N/A	N/A	1.7	Plasma
	0.3 g/L					
	4.34 mmol/L	N/A	N/A	N/A	5.2	Plasma
	0.6 g/L					
Sodium (Na ⁺)	180 mmol/L / mEq/L	N/A	N/A	0.116	N/A	Plasma
Strontium (Sr ²⁺)	150 µmol/L	N/A	N/A	< 0.08	N/A	Plasma
	300 µEq/L					
Thiocyanic acid	0.43 mmol/L	N/A	N/A	N/A	4.8	Plasma
	0.025 g/L					
	0.57 mmol/L	N/A	N/A	N/A	5.5	Plasma
	0.033 g/L					
	0.86 mmol/L	N/A	N/A	N/A	8.7	Plasma
	0.05 g/L					
	1.72 mmol/L	N/A	N/A	N/A	17.2	Plasma
	0.1 g/L					
Zinc (Zn ²⁺)	170 µmol/L	< 0.1	< 1	0.096	N/A	Plasma
	1111 µg/d					

Metabolites

These interference results are found for the metabolites:

Substance	Test concentration	Interference on ...		Test matrix
		cGlu (at 72 mg/dL)	cLac (at 14 mg/dL)	
Acetaminophen = paracetamol	2 mmol/L	< 1.8	< 0.9	Blood
	0.3 g/L			
Acetoacetate (lithium acetoacetate)	2 mmol/L	< 1.8	1.0	Blood
	20 mg/dL			
Acetylsalicylic acid	3.62 mmol/L	< 1.8	< 0.9	Blood
	0.65 g/L			
Ascorbic acid	170 µmol/L	< 1.8	< 0.9	Blood
	30 mg/L			
Bilirubin (conj)	0.2 g/L	< 1.8	< 0.9	Blood
Bilirubin (unconj)	0.2 g/L	< 1.8	< 0.9	Blood
Chlorpromazine HCl	0.2 mmol/L	< 1.8	< 0.9	Blood
	0.06 g/L			
Citrate (sodium citrate 2H ₂ O)	1 mmol/L	< 1.8	< 0.9	Blood
	0.19 g/L			
Citrate (trisodium citrate 2H ₂ O)	2.5 mmol/L	< 1.8	< 0.9	Blood
	5 mmol/L	< 1.8	< 0.9	Blood
	7.5 mmol/L	-1.8	< 0.9	Blood
	10 mmol/L	-2.0	-1.0	Blood
Creatinine	3 mmol/L	< 1.8	< 0.9	Blood
	0.34 g/L			
2-deoxy Glucose	2.5 mmol/L	41	N/A	Blood
	0.41 g/L			
	3.33 mmol/L	52	N/A	Blood
	0.55 g/L			
	5 mmol/L	82	N/A	Blood
	0.82 g/L			
10 mmol/L	172	< 0.9	Blood	
1.64 g/L				
Dopamine HCl	1 mmol/L	< 1.8	< 0.9	Blood

Substance	Test concentration	Interference on ...		Test matrix
		cGlu (at 72 mg/dL)	cLac (at 14 mg/dL)	
Dopamine HCl	0.15 g/L	< 1.8	< 0.9	Blood
D-Glucose	67 mmol/L	N/A	-1.9	Blood
	1206 mg/dL			
EDTA (edetate disodium 2H ₂ O)	3 mmol/L	< 1.8	< 0.9	Blood
	1 g/L			
Ethanol	87 mmol/L	< 1.8	< 0.9	Blood
	400 mg/dL			
Fluoride (sodium fluoride)	50 mmol/L	-2.2	-1.2	Blood
	0.95 g/L			
Formaldehyde	10 mmol/L	< 1.8	< 0.9	Blood
Formic acid	25 mmol/L	< 1.8	< 0.9	Blood
Galactose	3.3 mmol/L	2.5	< 0.9	Blood
	0.6 g/L			
Glucosamine HCl	2 mmol/L	2.2	< 0.9	Blood
	0.36 g/L			
Glycolic acid	0.25 mmol/L	N/A	2.8	Blood
	19 mg/L			
	0.33 mmol/L	N/A	3.5	Blood
	25 mg/L			
	0.5 mmol/L	N/A	4.3	Blood
	38 mg/L			
1 mmol/L	< 1.8	4.7	Blood	
76 mg/L				
Hemolysis	2 %	5.0	< 0.9	Blood
	5 %	3.1	1.4	Blood
	10 %	3.8	< 0.9	Blood
	20 %	4.3	< 0.9	Blood
Heparin	8000 iu/dL	< 1.8	< 0.9	Blood
Ibuprofen (sodium)	2.5 mmol/L	< 1.8	< 0.9	Blood
	0.52 g/L			
Intralipid	2 % (400 mg/dL)	< 1.8	< 0.9	Blood

Substance	Test concentration	Interference on ...		Test matrix
		cGlu (at 72 mg/dL)	cLac (at 14 mg/dL)	
Intralipid	5 % (1000 mg/dL)	< 1.8	< 0.9	Blood
Lactic acid	12 mmol/L	< 1.8	N/A	Blood
	108 mg/dL			
Maltose (monohy- drate)	5 mmol/L	< 1.8	< 0.9	Blood
	1.71 g/L			
Mannose	1 mmol/L	2.0	< 0.9	Blood
	0.18 g/L			
Methanol	75 mmol/L	< 1.8	< 0.9	Blood
Oxalate (sodium oxalate)	1 mmol/L	< 1.8	< 0.9	Blood
	0.09 g/L			
Pralidoxime chloride	0.045 mmol/L	< 1.8	< 0.9	Blood
	8 mg/L			
Pyruvate (pyruvic acid sodium salt)	2 mmol/L	< 1.8	< 0.9	Blood
	0.18 g/L			
Salicylic acid	4.34 mmol/L	< 1.8	< 0.9	Blood
	0.6 g/L			
Sodium thio- cyanate	6 mmol/L	259	99	Blood
	350 mg/L			
	8 mmol/L	348	131	Blood
	466 mg/L			
	12 mmol/L	559	197	Blood
	700 mg/L			
	24 mmol/L	1704	529	Blood
1400 mg/L				
Urea	84 mmol/L	< 1.8	< 0.9	Blood
	5 g/L			
Uric acid	1.5 mmol/L	< 1.8	< 0.9	Blood
	0.25 g/L			
Xylose	1 mmol/L	< 1.8	< 0.9	Blood
	0.15 g/L			

N/A: Interference has not been measured on the respective parameter

Numbers in brackets, i.e. <|1|: show that the interference lies within a range of ± the number in the brackets, i.e. <|1| = an interference within ±1.

The following interference results are found for ctBil. Bilirubin can only be measured on neonatal samples. This parameter is only available in the Neonate blood analysis 65 µL mode

Limit for clinical relevance	Test level(s)	Interference on ctBil			
		5 mg/dL		15 mg/dL	
		0.5 mg/dL	% Bias	1.5 mg/dL	% Bias
Fluorescein	40 mg/L	-15.4	-309	-16.6	-111
Patent Blue V = Sulphan blue*	10 mg/L	-4.7	-94	-6.5	-44
Methylene Blue*	-60 mg/L	-22.5	-449	-18.0	-120
Cardio Green = Indocyanine Green*	30 mg/L	-4.1	-82	-5.4	-36
Evans Blue	5 mg/L	< 0.5	< 10 %	< 1.5	< 10 %
Intralipid	5 % (1000 mg/dL)	< 0.5	< 10 %	< 1.5	< 10 %
SHb**	10 %	7.5	150	5.2	35
HbF	82 %	< 0.5	< 10 %	< 1.5	< 10 %
Hydroxocobalamin hydrochloride*	2 g/L	-15.8	-317	-12.8	-85
Cyanocobalamin*	2 g/L	-9.0	-180	-10.9	-73
Hemolysis	20 % (3000 mg/dL)	< 0.5	< 10 %	< 1.5	< 10 %
Triglyceride	~500 mg/dL	< 0.5	< 10 %	< 1.5	< 10 %

* The result is marked with error message "OXI spectrum mismatch".

** The result is marked with error message "SHb too high" if SHb >10%. The result is marked with message "Warning: SHb detected" if SHb >1 %.

pH was tested in the range from 6.8-7.9 and significant interference relative to physiological pH was not observed.

Additional known interferences: As the spectra for HiCN and Beta-carotene overlap with the spectrum of bilirubin, these are known interfering substances. Results from samples that contain these substances should not be used.

Results outside the reportable range will not be displayed.

Oximetry parameters

These interference results were found for the oximetry parameters:

ctHb	Test levels	Interference on ctHb	
		10 g/dL	20 g/dL
pH	6.8-8	< 0.5	< 0.5
Fluorescein**	250 mg/L	0.7	0.6
Beta-carotene*	3.7 µmol/L	< 0.5	< 0.5
Patent Blue V	10 mg/L	< 0.5	< 0.5
Methylene Blue**	45 mg/L	-0.8	-3.8
	60 mg/L	ND	-4.9
Cardio Green	30 mg/L	< 0.5	< 0.5
Evans Blue	5 mg/L	< 0.5	< 0.5
Intralipid	5 % (1000 mg/dL)	< 0.5	< 0.5
HiCN*/**	30 %	1.3	2.4
SHb***	10 %	< 0.5	< 0.5
Hydroxocobalamin hydrochloride**	2 g/L	2.1	1.6
Cyanocobalamin**	2 g/L	0.6	< 0.5
Bilirubin (conj)	342 µmol/L	< 0.5	< 0.5
Bilirubin (unconj)	342 µmol/L	< 0.5	< 0.5
Hemolysis	20 %	< 0.5	< 0.5
Triglyceride	587 mg/dL	< 0.5	< 0.5

* Interference calculated from the spectrum

** Analyzer message "OXI spectrum mismatch" is attached to the result

*** Analyzer message "SHb too high" is attached to the result

ND: Not determined

Numbers in brackets, i.e. <|1|; show that the interference lies within a range of ± the number in the brackets, i.e. <|1| = an interference within ±1.

sO ₂	Test levels	Interference on sO ₂	
		0 %	100 %
pH	6.8-8	< 1 %	< 1 %
Fluorescein**	250 mg/L	< 1 %	-3.0
Beta-carotene*	3.7 µmol/L	< 1 %	< 1 %
Patent Blue V	10 mg/L	< 1 %	< 1 %
Methylene Blue**	60 mg/L	< 1 %	3.9
Cardio Green	30 mg/L	< 1 %	1.0

sO₂		Interference on sO₂	
	Test levels	0 %	100 %
Evans Blue	5 mg/L	< 1 %	< 1 %
Intralipid	5 % (1000 mg/dL)	< 1 %	< 1 %
HiCN*/**	30 %	-3.1	-14.3
SHb***	10 %	1.6	< 1 %
HbF	50-80 %	< 1 %	< 1 %
Hydroxocobalamin hydrochloride**	2 g/L	-3.7	-1.1
Cyanocobalamin**	2 g/L	-2.0	-2.0
Bilirubin (conj)	342 µmol/L	< 1 %	< 1 %
Bilirubin (unconj)	342 µmol/L	< 1 %	< 1 %
Hemolysis	20 %	< 1 %	< 1 %
Triglyceride	587 mg/dL	< 1 %	< 1 %

* Interference calculated from the spectrum

** Analyzer message "OXI spectrum mismatch" is attached to the result

*** Analyzer message "SHb too high" is attached to the result

Numbers in brackets, i.e. <|1|: show that the interference lies within a range of ± the number in the brackets, i.e. <|1| = an interference within ±1.

COHb		Interference on COHb	
	Test levels	0 %	10 %
pH	6.8-8	< 1 %	< 1 %
Fluorescein**	250 mg/L	-4.1	-3.7
Beta-carotene*	3.7 µmol/L	< 1 %	< 1 %
Patent Blue V	10 mg/L	< 1 %	< 1 %
Methylene Blue**	60 mg/L	-1.8	1.2
Cardio Green	30 mg/L	< 1 %	< 1 %
Evans Blue	5 mg/L	< 1 %	< 1 %
Intralipid	5 % (1000 mg/dL)	< 1 %	< 1 %
HiCN*/**	30 %	6.5	2.8
SHb***	10 %	< 1 %	< 1 %
HbF	50-80 %	< 1 %	ND
Hydroxocobalamin hydrochloride**	2 g/L	2.1	< 1 %
Cyanocobalamin**	2 g/L	1.6	< 1 %
Bilirubin (conj)	342 µmol/L	< 1 %	< 1 %

COHb	Interference on COHb		
	Test levels	0 %	10 %
Bilirubin (unconj)	342 µmol/L	< 1 %	< 1 %
Hemolysis	20 %	< 1 %	< 1 %
Triglyceride	587 mg/dL	< 1 %	< 1 %

* Interference calculated from the spectrum

** Analyzer message "OXI spectrum mismatch" is attached to the result

*** Analyzer message "SHb too high" is attached to the result

Numbers in brackets, i.e. <|1|: show that the interference lies within a range of ± the number in the brackets, i.e. <|1| = an interference within ±1.

ND: Not determined

Methb	Interference on Methb		
	Test levels	0 %	10 %
pH	6.8-8	< 1 %	-1.1 %/pH
Fluorescein**	250 mg/L	10.1	9.7
Beta-carotene*	3.7 µmol/L	< 1 %	< 1 %
Patent Blue V	10 mg/L	-1.0	< 1 %
Methylene Blue**	30 mg/L	-12.0	-17.9
	60 mg/L	-24.0	ND
Cardio Green	30 mg/L	-2.0	-1.2
Evans Blue	5 mg/L	< 1 %	< 1 %
Intralipid	5 % (1000 mg/dL)	< 1 %	< 1 %
HiCN*/**	30 %	23.9	20.6
SHb***	10 %	1.0	-4.9
HbF	50-80 %	< 1 %	ND
Hydroxocobalamin hydrochloride**	2 g/L	14.2	12.9
Cyanocobalamin**	2 g/L	5.7	4.7
Bilirubin (conj)	342 µmol/L	< 1 %	< 1 %
Bilirubin (unconj)	342 µmol/L	< 1 %	< 1 %
Hemolysis	20 %	< 1 %	< 1 %
Triglyceride	587 mg/dL	< 1 %	< 1 %

* Interference calculated from the spectrum

** Analyzer message "OXI spectrum mismatch" is attached to the result

*** Analyzer message "SHb too high" is attached to the result

Numbers in brackets, i.e. <|1|: show that the interference lies within a range of ± the number in the brackets, i.e. <|1| = an interference within ±1.

ND: Not determined

O ₂ Hb	Test levels	Interference on O ₂ Hb	
		0 %	100 %
pH	6.8-8	< 1 %	< 1 %
Fluorescein**	250 mg/L	< 1 %	-8.8
Beta-carotene*	3.7 µmol/L	< 1 %	< 1 %
Patent Blue V	10 mg/L	< 1 %	2.0
Methylene Blue**	60 mg/L	< 1 %	32.0
Cardio Green	30 mg/L	< 1 %	2.7
Evans Blue	5 mg/L	< 1 %	< 1 %
Intralipid	5 % (1000 mg/dL)	< 1 %	< 1 %
HiCN*/**	30 %	-2.1	-40.2
SHb***	10 %	1.6	-2.1
HbF	50-80 %	< 1 %	< 1 %
Hydroxocobalamin hydrochloride**	2 g/L	-2.8	-17.2
Cyanocobalamin**	2 g/L	-1.8	-8.8
Bilirubin (conj)	342 µmol/L	< 1 %	< 1 %
Bilirubin (unconj)	342 µmol/L	< 1 %	< 1 %
Hemolysis	20 %	< 1 %	< 1 %
Triglyceride	587 mg/dL	< 1 %	< 1 %

* Interference calculated from the spectrum

** Analyzer message "OXI spectrum mismatch" is attached to the result

*** Analyzer message "SHb too high" is attached to the result

Numbers in brackets, i.e. <|1|: show that the interference lies within a range of ± the number in the brackets, i.e. <|1| = an interference within ±1.

HHb	Test levels	Interference on RHb	
		0 %	100 %
pH	6.8-8	< 1 %	< 1 %
Fluorescein**	250 mg/L	2.8	-2.9
Beta-carotene*	3.7 µmol/L	< 1 %	< 1 %
Patent Blue V	10 mg/L	< 1 %	< 1 %
Methylene Blue**	45 mg/L	-3.3	-2.9

HHb	Interference on RHb		
	Test levels	0 %	100 %
Methylene Blue**	60 mg/L	-4.4	ND
Cardio Green	30 mg/L	< 1 %	< 1 %
Evans Blue	5 mg/L	< 1 %	< 1 %
Intralipid	5 % (1000 mg/dL)	< 1 %	< 1 %
HiCN*/**	30 %	9.8	-28.3
SHb***	10 %	< 1 %	1.2
HbF	50-80 %	< 1 %	< 1 %
Hydroxocobalamin hydrochloride**	2 g/L	< 1 %	-19.8
Cyanocobalamin**	2 g/L	1.8	-5.0
Bilirubin (conj)	342 µmol/L	< 1 %	< 1 %
Bilirubin (unconj)	342 µmol/L	< 1 %	< 1 %
Hemolysis	20 %	< 1 %	< 1 %
Triglyceride	587 mg/dL	< 1 %	< 1 %

* Interference calculated from the spectrum

** Analyzer message "OXI spectrum mismatch" is attached to the result

*** Analyzer message "SHb too high" is attached to the result

Numbers in brackets, i.e. <|1|: show that the interference lies within a range of ± the number in the brackets, i.e. <|1| = an interference within ±1.

ND: Not determined

HbF	Interference on HbF	
	Test levels	80 %
pH	6.8-8	40 %/pH
Fluorescein**	25 mg/L****	< 20 %
Beta-carotene*	3.7 µmol/L	< 20 %
Patent Blue V	10 mg/L	-37
Methylene Blue**	7.5 mg/L****	< 20 %
Cardio Green	30 mg/L	-30
Evans Blue	5 mg/L	< 20 %
Intralipid	5 % (1000 mg/dL)	< 20 %
HiCN* / **	30 %	HbF not reported
SHb***	10 %	HbF not reported
Hydroxocobalamin hydrochloride**	2 g/L	< 20 %

HbF	Interference on HbF	
	Test levels	80 %
Cyanocobalamin**	2 g/L	< 20 %
Bilirubin (conj)	342 µmol/L	< 20 %
Bilirubin (unconj)	342 µmol/L	< 20 %
Hemolysis	20 %	< 20 %
Triglyceride	587 mg/dL	< 20 %

* Interference calculated from the spectrum

** Analyzer message "OXI spectrum mismatch" is attached to the result

*** Analyzer message "SHb too high" is attached to the result

**** HbF is not reported for higher levels

Numbers in brackets, i.e. <|1|: show that the interference lies within a range of ± the number in the brackets, i.e. <|1| = an interference within ±1.

ctBil sensitivity for MCHC variations

MCHC (Mean Corpuscular Hemoglobin Concentration) is used to estimate hematocrit, Hct, which is used in the ctBil measurement (Bilirubin can only be measured on neonatal samples. This parameter is only available in the Neonate blood analysis 65 µL mode.). MCHC is an average Hb concentration in the red blood cell (RBC). If the RBC volume decreases, MCHC increases. If an RBC has iron deficit, MCHC decreases.

Hct is determined from ctHb as follows:

$$\text{Hct} = \text{ctHb} / \text{MCHC}$$

A standard value of 332 g/L is used for MCHC which gives $\text{Hct} = \text{ctHb} \times 0.0301$ if the unit for ctHb is g/dL.

MCHC can, however, deviate from this standard value as shown in the table.

Metric values that use the erythrocytes Hct and MCHC to be determined are given for apparently healthy white and black people of different ages [23].

Group of people	Age	Hct mean	Hct 95 % range	MCHC mean, g/L	MCHC 95 % range, g/L
Men	Adults	0.47	0.39-0.55	340	310-370
Women	Adults	0.42	0.36-0.48	330	300-360

Group of people	Age	Hct mean	Hct 95 % range	MCHC mean, g/L	MCHC 95 % range, g/L
Boys	Newborn	0.59	0.53-0.65	330	320-340
	1 month	0.50	0.44-0.56	320	310-330
	3 months	0.45	0.39-0.52	330	320-340
	6 months	0.46	0.39-0.51	300	290-310
	9 months	0.45	0.39-0.52	280	270-300
	1 year	0.41	0.37-0.45	290	280-300
	2 years	0.40	0.36-0.47	300	280-310
	4 years	0.37	0.30-0.44	280	270-290
	8 years	0.41	0.37-0.45	290	280-300
	14 years	0.41	0.36-0.46	300	290-310
Girls	Newborn	0.58	0.51-0.65	340	330-350
	1 month	0.49	0.42-0.56	320	310-330
	3 months	0.44	0.39-0.51	330	320-340
	6 months	0.44	0.39-0.50	320	310-330
	9 months	0.43	0.37-0.50	300	290-310
	1 year	0.43	0.37-0.49	300	290-310
	2 years	0.43	0.36-0.50	300	290-310
	4 years	0.43	0.36-0.51	280	270-290
	8 years	0.40	0.36-0.46	280	270-290
	14 years	0.40	0.36-0.47	290	280-300

If ΔMCHC is defined as $\Delta\text{MCHC} = 332 \text{ g/L} - \text{MCHC}$, then the contribution to the relative error on the ctBil^* measurement is as follows:

$$\Delta\text{ctBil}^* / \text{ctBil}^* = -(\text{Hct} / 1 - \text{Hct}) \times (\Delta\text{MCHC} / \text{MCHC})$$

A worst-case example, where 95 % confidence values are used:

A newborn girl with $\text{Hct} = 0.58$, $\text{MCHC} = 350 \text{ g/L}$ and $\text{ctBil}^* = 400 \mu\text{mol/L}$. ctHb may be derived as $\text{Hct} \times \text{MCHC} = 0.58 \times 350 \text{ g/L} = 20.3 \text{ g/dL}$ (reference range is 18.0-21.0 g/dL).

$$\Delta\text{ctBil}^* / \text{ctBil}^* = -(0.58/1 - 0.58) \times (-18/350) = +0.071 \text{ and } \Delta\text{ctBil}^* = 0.071 \times 400 = 28 \mu\text{mol/L}.$$

If the reference value for Hct is known, it is possible to correct the shown ctBil^* value with this equation:

$$\text{ctBil}^*_{\text{corrected}} = \text{ctBil}^*_{\text{displayed}} \times (1 - \text{ctHb}_{\text{displayed}} \times 0.0301 / 1 - \text{Hct}_{\text{reference}})$$

ctHb is measured in g/dL.

ctBil^* is sensitive to pH deviations from the nominal value of $\text{pH} = 7.4$.

*Bilirubin can only be measured on neonatal samples. This parameter is only available in the Neonate blood analysis 65 μL mode.

Alternative presentation of interference results

pH/blood gas (alternative presentation)

Substance	Max. Conc. tested	Highest interferent level free from interference			Test matrix
		pH	pCO ₂	pO ₂	
		Interference limit			
		10 mpH	0.5 mmHg / 0.067 kPa	1 mmHg / 0.13 kPa	
Intralipid	5% (1000 mg/dL)	*	*	*	Blood / aqueous
Fluorescein	400 mg/L	*	*	*	Blood
K ⁺	17 mmol/L / mEq/L	*	-	-	Blood
Na ⁺	190 mmol/L / mEq/L	*	-	-	Blood
Ca ²⁺	5.5 mmol/L	*	-	-	Blood
	11 mEq/L				
	22 mg/dL				
Hemolysis	20 %	*	*	13.3 %	Blood
Unconj. Bilirubin	500 µmol/L	*	*	*	Blood
	29.2 mg/dL				
Conj. Bilirubin	400 µmol/L	*	*	*	Blood
	23.4 mg/dL				

* = No interference within the tested concentration range.

- = Not tested.

Electrolytes (alternative presentation)

Substance	Test concentration	Highest interferent level free from interference				Test matrix
		cK ⁺	cNa ⁺	cCa ²⁺	cCl ⁻	
		Interference limit				
		0.1 mmol/L / 0.1 mEq/L	1 mmol/L / 1 mEq/L	0.2 mmol/L / 0.04 mEq/L / 0.08 mg/dL	1 mmol/L / 1 mEq/L	
Lithium (Li ⁺)	3.2 mmol/L / mEq/L	*	*	*	-	Plasma

Potassium (K ⁺)	12 mmol/L / mEq/L	-	*	*	-	Plasma	
Calcium (Ca ²⁺)	3.4 mmol/L	*	2.8 mmol/L	-	-	Plasma	
	6.8 mEq/L						5.6 mEq/L
	13.6 mg/dL						11.2 mg/dL
Sodium (Na ⁺)	180 mmol/L / mEq/L	-	-	124 mmol/L / mEq/L	-	Plasma	
Ammonium (NH ₄ ⁺)	1 mmol/L	*	*	-	0.9 mmol/L	Plasma	
	1.7 mg/dL				1.5 mg/dL		
Magnesium (Mg ²⁺)	15 mmol/L	-	*	13.0 mmol/L	-	Aqueous	
	30 mEq/L						26.0 mEq/L
Zinc (Zn ²⁺)	170 µmol/L	*	*	142 µmol/L	-	Plasma	
	1111 µg/dL						928 µg/dL
Strontium (Sr ²⁺)	150 µmol/L	-	-	*	-	Plasma	
	300 µEq/L						
pH	6.8-8	-	-	0.54 pH-units	*	Aqueous/ plasma	
Bromide (Br ⁻)	37.5 mmol/L / mEq/L	-	-	-	0.5 mmol/L / mEq/L	Plasma	
Iodide (I ⁻)	2.99 mmol/L / mEq/L	-	-	-	0.3 mmol/L / mEq/L	Plasma	
Fluoride (F ⁻)	1 mmol/L / mEq/L	-	-	-	*	Plasma	
Perchlorate (ClO ₄ ⁻)	1.5 mmol/L / mEq/L	-	-	*	0.2 mmol/L / mEq/L	Plasma	
Benzalko- nium chloride	30 µg/mL	2.4 µg/mL	0.75 µg/mL	1 µg/mL	*	Plasma	
Acetylsali- cylic acid	3.62 mmol/L	-	-	-	1.7 mmol/L	Plasma	
	0.65 g/L				0.31 g/L		
Salicylic acid	4.34 mmol/L	-	-	-	1.5 mmol/L	Plasma	
	0.6 g/L				0.2 g/L		
Thiocyanic acid	1.72 mmol/L	-	-	-	0.1 mmol/L	Plasma	

Thiocyanic acid	0.1 g/L	-	-	-	6 mg/L	Plasma
Ascorbic acid	850 µmol/L	-	-	-	*	Plasma
	0.15 g/L					
Citrate	40 mmol/L	-	-	-	8 mmol/L	Plasma
	7.7 g/L				1.5 g/L	
Oxalate	10 mmol/L	-	-	-	*	Plasma
	0.9 g/L					
Lactate	25 mmol/L	-	-	-	*	Plasma
	225 mg/dL					
Caprylic acid	0.12 mmol/L	-	-	-	*	Plasma
	0.017 g/L					
Acetyl-tryptophane	0.12 mmol/L	-	-	-	*	Plasma
	0.03 g/L					
Hemolysis	20%	0.15 %	0.85 %	0.47 %	1.27 %	Blood
Intralipid	5%	*	2 %	*	3 %	Plasma
Unconj. Bilirubin	500 µmol/L	*	*	*	500 µmol/L	Blood
	29.2 mg/dL				29.2 mg/dL	
Conj. Bilirubin	400 µmol/L	*	305 µmol/L	*	*	Blood
	23.4 mg/dL		17.9 mg/dL			

* = No interference within the tested concentration range.

- = Not tested.

Metabolites (alternative presentation)

Substance	Max. Conc. tested	Highest interferent level free from interference		Test matrix
		Glu	Lac	
		Interference limit		
		0.1 mmol/L / 1.8 mg/dL	0.1 mmol/L / 0.9 mg/dL	
Acetaminophen = paracetamol	2 mmol/L	*	*	Blood
	0.3 g/L			
Acetylsalicylic acid	3.62 mmol/L	*	*	Blood
	0.65 g/L			

Ibuprofen (sodium)	2.5 mmol/L	*	*	Blood
	0.52 g/L			
Dopamine HCl	1 mmol/L	*	*	Blood
	0.15 g/L			
Chlorpromazine HCl	0.2 mmol/L	*	*	Blood
	0.06 g/L			
Ethanol	87 mmol/L	*	*	Blood
	400 mg/dL			
Glucosamine HCl	2 mmol/L	1.67 mmol/L	*	Blood
	0.36 g/L	0.3 g/L		
Glycolic acid	1 mmol/L	*	0.08 mmol/L	Blood
	76 mg/L		6 mg/L	
Lactic acid	12 mmol/L	*		Blood
	108 mg/dL			
Maltose (mono-hydrate)	5 mmol/L	*	*	Blood
	1.71 g/L			
Mannose	1 mmol/L	0.9 mmol/L	*	Blood
	0.18 g/L	0.16 g/L		
Salicylic acid	4.34 mmol/L	*	*	Blood
	0.6 g/L			
Sodium thiocyanate	24 mmol/L	0.065 mmol/L	0.07 mmol/L	Blood
	1400 mg/L	3.8 mg/L	4.1 g/L	
Xylose	1 mmol/L	*	*	Blood
	0.15 g/L			
Acetoacetate (Lithium acetate-acetate)	2 mmol/L	*	1.8 mmol/L	Blood
	20 mg/dL		18 mg/dL	
Creatinine	3 mmol/L	*	*	Blood
	0.34 g/L			
Galactose	3.3 mmol/L	2.3 mmol/L	*	Blood
	0.6 g/L	0.4 g/L		
D-Glucose	67 mmol/L		32 mmol/L	Blood
	1206 mg/dL		576 mg/dL	
Pyruvate (pyruvic acid sodium salt)	2 mmol/L	*	*	Blood
	0.18 g/L			

Urea	84 mmol/L	*	*	Blood
	5 g/L			
Uric acid	1.5 mmol/L	*	*	Blood
	0.25 g/L			
Heparin	8000 iu/dL	*	*	Blood
EDTA (Edetate disodium 2H ₂ O)	3 mmol/L	*	*	Blood
	1 g/L			
Citrate (sodium citrate 2H ₂ O)	1 mmol/L	*	*	Blood
	0.19 g/L			
Oxalate (sodium oxalate)	1 mmol/L	*	*	Blood
	0.09 g/L			
Fluoride (Sodium fluoride)	50 mmol/L	41 mmol/L	38 mM	Blood
	0.95 g/L	0.8 g/L	0.72 g/L	
Pralidoxime chloride	0.045 mmol/L	*	*	Blood
	8 mg/L			
2-deoxy Glucose	10 mmol/L	0.1 mmol/L	-	Blood
	1.64 g/L	16 mg/L		
Unconjugated Bilirubin	0.2 g/L	*	*	Blood
Conjugated Bilirubin	0.2 g/L	*	*	Blood
Ascorbic acid	170 µmol/L	*	*	Blood
	30 mg/L			
Intralipid	5 % (1000 mg /dL)	*	*	Blood
Hemolysis	20 %	8.3%	*	Blood
Methanol	75 mmol/L	*	*	Blood
Formaldehyde	10 mmol/L	*	*	Blood
Formic Acid	25 mmol/L	*	*	Blood

* = No interference within the tested concentration range.

- = Not tested.

ctBil (Bilirubin can only be measured on neonatal samples. This parameter is only available in the Neonate blood analysis 65 µL mode.

Interference dose response test results		
Potential Interferent	Concentration of interfering substances above which significant interference ($\geq\pm 10\%$) occurs	
	85 $\mu\text{mol/L}$ ctBil** or 5 mg/dL ctBil**	260 $\mu\text{mol/L}$ ctBil** or 15 mg/dL ctBil**
Fluorescein	1.5 mg/L	4 mg/L
Patent Blue V = Sulphan blue	1.5 mg/L	2.5 mg/L
Methylene Blue	0.75 mg/L	2 mg/L
Cardio Green = Indocyanine Green	3 mg/L	10 mg/L
Evans Blue	*	*
Intralipid	*	*
SHb	1.1 %	1.6 %
HbF	*	*
Hydroxocobalamin hydrochloride	0.19 g/L	0.5 g/L
Cyanocobalamin	0.2 g/L	0.7 g/L
Hemolysis	*	*
Triglyceride	*	*

* No interference within the tested concentration range.

** ctBil (Bilirubin can only be measured on neonatal samples. This parameter is only available in the Neonate blood analysis 65 μL mode.

pH was tested in the range from 6.8-7.9 and significant interference relative to physiological pH was not observed.

Additional known interferences: As the spectra for HiCN and Beta-carotene overlap with the spectrum of bilirubin, these are known interfering substances. Results from samples that contain these substances should not be used.

Oximetry parameters (alternative presentation)

ctHb	Test levels	Highest interferent level free from interference	
		10 g/dL	20 g/dL
Interference limit		0.5 g/dL	0.5 g/dL
pH	6.8-8	*	*
Fluorescein	250 mg/L	172 mg/L	140 mg/L
Beta-carotene	3.7 $\mu\text{mol/L}$	*	*
Patent Blue V	10 mg/L	*	*
Methylene Blue	45 mg/L	29.1 mg/L	6.0 mg/L

ctHb		Highest interferent level free from interference	
	Test levels	10 g/dL	20 g/dL
Interference limit		0.5 g/dL	0.5 g/dL
Methylene Blue	60 mg/L	ND	6.0 mg/L
Cardio Green	30 mg/L	*	*
Evans Blue	5 mg/L	*	*
Intralipid	5 % (1000 mg/dL)	*	*
HiCN	30 %	11.4 %	6.2 %
SHb	10 %	*	*
Hydroxocobalamin hydrochloride	2 g/L	0.8 g/L	0.6 g/L
Cyanocobalamin	2 g/L	1.8 g/L	*
Bilirubin (conj)	342 µmol/L	*	*
Bilirubin (unconj)	342 µmol/L	*	*
Hemolysis	20 %	*	*
Triglyceride	587 mg/dL	*	*

* = No interference within the tested concentration range

sO₂		Highest interferent level free from interference	
	Test levels	0 %	100 %
Interference limit		1 %	1 %
pH	6.8-8	*	*
Fluorescein	250 mg/L	*	83 mg/L
Beta-carotene	3.7 µmol/L	*	*
Patent Blue V	10 mg/L	*	*
Methylene Blue	60 mg/L	*	17 mg/L
Cardio Green	30 mg/L	*	30 mg/L
Evans Blue	5 mg/L	*	*
Intralipid	5 % (1000 mg/dL)	*	*
HiCN	30 %	10 %	2 %
SHb	10 %	6 %	*
HbF	50-80 %	*	*
Hydroxocobalamin hydrochloride	2 g/L	0.6 g/L	1.9 g/L
Cyanocobalamin	2 g/L	1.0 g/L	1.4 g/L

sO₂		Highest interferent level free from interference	
	Test levels	0 %	100 %
Interference limit		1 %	1 %
Bilirubin (conj)	342 µmol/L	*	'
Bilirubin (unconj)	342 µmol/L	*	*
Hemolysis	20 %	*	*
Triglyceride	587 mg/dL	*	*

* = No interference within the tested concentration range

COHb		Highest interferent level free from interference	
	Test levels	0 %	10 %
Interference limit		1 %	1 %
pH	6.8-8	*	*
Fluorescein	250 mg/L	61 mg/L	67 mg/L
Beta-carotene	3.7 µmol/L	*	*
Patent Blue V	10 mg/L	*	*
Methylene Blue	60 mg/L	45 mg/L	48 mg/L
Cardio Green	30 mg/L	*	*
Evans Blue	5 mg/L	*	*
Intralipid	5 % (1000 mg/dL)	*	*
HiCN	30 %	4.5 %	10.4 %
SHb	10 %	*	*
HbF	50-80 %	*	ND
Hydroxocobalamin hydrochloride	2 g/L	1 g/L	*
Cyanocobalamin	2 g/L	1.3 g/L	*
Bilirubin (conj)	342 µmol/L	*	*
Bilirubin (unconj)	342 µmol/L	*	*
Hemolysis	20 %	*	*
Triglyceride	587 mg/dL	*	*

* = No interference within the tested concentration range

ND: Not determined

MetHb		Highest interferent level free from interference	
	Test levels	0 %	10 %
Interference limit		1 %	1 %
pH	6.8-8	*	0.9 pH-unit
Fluorescein	250 mg/L	23 mg/L	24 mg/L
Beta-carotene	3.7 µmol/L	*	*
Patent Blue V	10 mg/L	11 mg/L	*
Methylene Blue	30 mg/L	2.5 mg/L	1.6 mg/L
	60 mg/L	2.5 mg/L	ND
Cardio Green	30 mg/L	16 mg/L	28 mg/L
Evans Blue	5 mg/L	*	*
Intralipid	5 % (1000 mg/dL)	*	*
HiCN	30 %	1.3 %	1.5 %
SHb	10 %	10 %	1.2 %
HbF	50-80 %	*	ND
Hydroxocobalamin hydrochloride	2 g/L	0.14 g/L	0.15 g/L
Cyanocobalamin	2 g/L	0.37 g/L	0.43 g/L
Bilirubin (conj)	342 µmol/L	*	*
Bilirubin (unconj)	342 µmol/L	*	*
Hemolysis	20 %	*	*
Triglyceride	587 mg/dL	*	*

* = No interference within the tested concentration range

ND: Not determined

O₂Hb		Highest interferent level free from interference	
	Test levels	0 %	100 %
Interference limit		1 %	1 %
pH	6.8-8	*	*
Fluorescein	250 mg/L	*	26 mg/L
Beta-carotene	3.7 µmol/L	*	*
Patent Blue V	10 mg/L	*	5 mg/L
Methylene Blue	60 mg/L	*	2 mg/L
Cardio Green	30 mg/L	*	10 mg/L
Evans Blue	5 mg/L	*	*

O₂Hb		Highest interferent level free from interference	
	Test levels	0 %	100 %
Interference limit		1 %	1 %
Intralipid	5 % (1000 mg/dL)	*	*
HiCN	30 %	14 %	0.7 %
SHb	10 %	6 %	5 %
HbF	50-80 %	*	*
Hydroxocobalamin hydrochloride	2 g/L	0.7 g/L	0.1 g/L
Cyanocobalamin	2 g/L	1.1 g/L	0.2 g/L
Bilirubin (conj)	342 µmol/L	*	*
Bilirubin (unconj)	342 µmol/L	*	*
Hemolysis	20 %	*	*
Triglyceride	587 mg/dL	*	*

* = No interference within the tested concentration range

HHb		Highest interferent level free from interference	
	Test levels	0 %	100 %
Interference limit		1 %	1 %
pH	6.8-8	*	*
Fluorescein	250 mg/L	89 mg/L	87 mg/L
Beta-carotene	3.7 µmol/L	*	*
Patent Blue V	10 mg/L	*	*
Methylene Blue	45 mg/L	14 mg/L	16 mg/L
	60 mg/L	14 mg/L	ND
Cardio Green	30 mg/L	*	*
Evans Blue	5 mg/L	*	*
Intralipid	5 % (1000 mg/dL)	*	*
HiCN	30 %	3 %	1 %
SHb	10 %	*	8 %
HbF	82 %	*	*
Hydroxocobalamin hydrochloride	2 g/L	*	0.1 g/L
Cyanocobalamin	2 g/L	1.6 g/L	0.4 g/L
Bilirubin (conj)	342 µmol/L	*	*

HHb		Highest interferent level free from interference	
	Test levels	0 %	100 %
Interference limit		1 %	1 %
Bilirubin (unconj)	342 µmol/L	*	*
Hemolysis	20 %	*	*
Triglyceride	587 mg/dL	*	*

* = No interference within the tested concentration range

ND: Not determined

HbF		Highest interferent level free from interference
	Test levels	80 %
Interference limit		20 %
pH	6.8-8	0.5 pH-unit
Fluorescein	25 mg/L	*
Beta-carotene	3.7 µmol/L	*
Patent Blue V	10 mg/L	5 mg/L
Methylene Blue	7.5 mg/L	*
Cardio Green	30 mg/L	20 mg/L
Evans Blue	5 mg/L	*
Intralipid	5 % (1000 mg/dL)	*
HiCN	30 %	HbF not reported
SHb	10 %	HbF not reported
Hydroxocobalamin hydrochloride	2 g/L	*
Cyanocobalamin	2 g/L	*
Bilirubin (conj)	342 µmol/L	*
Bilirubin (unconj)	342 µmol/L	*
Hemolysis	20 %	*
Triglyceride	587 mg/dL	*

* = No interference within the tested concentration range

External test results

Study design - precision/reproducibility

A point-of-care (POC) precision study was done with the use of NCCLS "Evaluation of Precision Performance of Quantitative Measurement Methods; Approved Guideline – Second Edition", NCCLS EP5-A2, 2004 as guidance [1].

The study was done at three different POC sites. The sites were not the same for all the parameters and the measurements were not performed at the same time. Some of the results derive from measurements started at different times and at different sites.

Each site used one ABL90 FLEX analyzer for precision evaluation of syringe mode, one ABL90 FLEX analyzer for precision evaluation of capillary mode and one ABL735 analyzer for reference purposes.

The test material was prepared samples of heparinized whole blood, except for ctBil* where aqueous solutions were used. Samples for all parameters, preparations simulating high, medium and low physiological levels.

In each study multiple POC staff members performed sample handling and transfer. Each study was done over 20 test days. On each test day, tests were done on each parameter and level in duplicate per run, two runs per day. The testing was done in both syringe and capillary modes. Sr is an estimate of repeatability and ST is an estimate of precision as defined in NCCLS EP5-A2 [1].

* Bilirubin can only be measured on neonatal samples. This parameter is only available in the Neonate blood analysis 65 μ L mode.

ABL90 FLEX precision - syringe study - site 1

Low level	pH	pCO ₂	pO ₂	Ca	Cl	K
Unit		mmHg	mmHg	mg/dL	mEq/L	mEq/L
Mean	7.267	28.1	44.8	2.28	93	-
Sr	0.0016	0.42	0.20	0.01	0.25	-
ST	0.0031	0.59	0.84	0.07	0.94	-
% CV	-	2.1	1.9	3.1	1.0	-
n	80	80	80	80	80	-

Low level	Na	Glu	Lac	tHb	sO ₂	COHb
Unit	mEq/L	mg/dL	mg/dL	g/dL	%	%
Mean	119	11.8	-	3.8	76.2	-
Sr	0.2	0.49	-	0.06	0.32	-
ST	0.6	0.93	-	0.07	0.45	-
% CV	0.5	7.9	-	1.9	0.6	-
n	80	80	-	80	80	-

Low level	MetHb	HHb	O ₂ Hb	HbF	ctBil*	
Unit	%	%	%	%	mg/dL	
Mean	-	-	74.1	-	2.1	
Sr	-	-	0.30	-	0.057	
ST	-	-	0.34	-	0.099	
% CV	-	-	0.5	-	4.8	
n	-	-	80	-	80	

Medium level	pH	pCO ₂	pO ₂	Ca	Cl	K
Unit		mmHg	mmHg	mg/dL	mEq/L	mEq/L
Mean	7.363	42.0	78.0	4.83	108	4.87
Sr	0.0016	0.52	0.37	0.02	0.25	0.049
ST	0.0036	0.80	1.19	0.07	1.22	0.083
% CV	-	1.9	1.5	1.5	1.1	1.7
n	80	80	80	80	80	80

Medium level	Na	Glu	Lac	tHb	sO ₂	COHb
Unit	mEq/L	mg/dL	mg/dL	g/dL	%	%
Mean	141	95.4	19.2	14.8	92.9	3.4
Sr	0.4	0.70	0.45	0.09	0.17	0.04
ST	0.7	2.77	1.07	0.14	0.39	0.18
% CV	0.5	2.9	5.6	0.9	0.4	5.2
n	80	80	80	80	80	80

Medium level	MethHb	HHb	O ₂ Hb	HbF	ctBil*	
Unit	%	%	%	%	mg/dL	
Mean	3.1	6.9	90.6	46.6	7.3	
Sr	0.08	0.17	0.21	1.70	0.063	
ST	0.15	0.29	0.27	5.02	0.110	
% CV	4.8	4.2	0.3	10.8	1.5	
n	80	80	80	80	80	

High level	pH	pCO ₂	pO ₂	Ca	Cl	K
Unit		mmHg	mmHg	mg/dL	mEq/L	mEq/L
Mean	7.471	61.0	206.3	7.62	122	6.58
Sr	0.0010	0.88	2.21	0.04	0.22	0.022
ST	0.0029	1.81	3.55	0.11	0.81	0.053
% CV	-	3.0	1.7	1.5	0.7	0.8
n	80	80	80	80	80	80

High level	Na	Glu	Lac	tHb	sO ₂	COHb
Unit	mEq/L	mg/dL	mg/dL	g/dL	%	%
Mean	151	252.5	146.3	21.4	99.9	42.1
Sr	0.3	2.16	4.04	0.08	0.09	0.09

High level	Na	Glu	Lac	tHb	sO ₂	COHb
ST	0.8	8.03	8.56	0.15	0.22	0.21
% CV	0.5	3.2	5.9	0.7	0.2	0.5
n	80	80	80	80	80	80

High level	MetHb	HHb	O ₂ Hb	HbF	ctBil*	
Unit	%	%	%	%	mg/dL	
Mean	9.6	23.5	97.5	69.6	30.4	
Sr	0.07	0.23	0.16	5.70	0.204	
ST	0.21	0.39	0.19	8.25	0.274	
% CV	2.2	1.7	0.2	11.9	0.9	
n	80	80	80	80	80	

* Bilirubin can only be measured on neonatal samples. This parameter is only available in the Neonate blood analysis 65 µL mode.

ABL90 FLEX precision - syringe study - site 3

Low level	pH	pCO ₂	pO ₂	Ca	Cl	K
Unit		mmHg	mmHg	mg/dL	mEq/L	mEq/L
Mean	7.277	28.2	45.0	2.39	94	-
Sr	0.0022	0.59	0.17	0.02	0.11	-
ST	0.0036	0.75	0.60	0.09	1.12	-
% CV	-	2.7	1.3	3.8	1.2	-
n	80	80	80	80	80	-

Low level	Na	Glu	Lac	tHb	sO ₂	COHb
Unit	mEq/L	mg/dL	mg/dL	g/dL	%	%
Mean	119	13.8	-	3.8	75.5	-
Sr	0.3	0.57	-	0.05	0.17	-
ST	0.7	1.50	-	0.07	0.27	-
% CV	0.6	10.8	-	1.8	0.4	-
n	80	80	-	80	80	-

Low level	MetHb	HHb	O ₂ Hb	HbF	ctBil*	
Unit	%	%	%	%	mg/dL	
Mean	-	-	71.1	-	2.1	
Sr	-	-	0.22	-	0.050	
ST	-	-	0.37	-	0.084	

Low level	MethHb	HHb	O ₂ Hb	HbF	ctBil*	
% CV	-	-	0.5	-	4.1	
n	-	-	80	-	80	

Medium level	pH	pCO ₂	pO ₂	Ca	Cl	K
Unit		mmHg	mmHg	mg/dL	mEq/L	mEq/L
Mean	7.372	42.0	73.6	4.87	108	4.68
Sr	0.0010	0.63	0.92	0.02	0.25	0.025
ST	0.0029	0.83	1.17	0.09	1.23	0.059
% CV	-	2.0	1.6	1.9	1.1	1.3
n	80	80	80	80	80	80

Medium level	Na	Glu	Lac	tHb	sO ₂	COHb
Unit	mEq/L	mg/dL	mg/dL	g/dL	%	%
Mean	141	96.9	19.0	15.1	93.0	3.3
Sr	0.4	0.57	0.45	0.10	0.09	0.07
ST	0.7	3.69	1.20	0.11	0.29	0.22
% CV	0.5	3.8	6.3	0.7	0.3	6.7
n	80	80	80	80	80	80

Medium level	MethHb	HHb	O ₂ Hb	HbF	ctBil*	
Unit	%	%	%	%	mg/dL	
Mean	3.7	6.8	89.9	39.1	7.3	
Sr	0.07	0.09	0.16	2.12	0.049	
ST	0.17	0.30	0.24	5.57	0.094	
% CV	4.6	4.4	0.3	14.3	1.3	
n	80	80	80	80	80	

High level	pH	pCO ₂	pO ₂	Ca	Cl	K
Unit		mmHg	mmHg	mg/dL	mEq/L	mEq/L
Mean	7.470	59.8	201.6	7.52	123	6.69
Sr	0.0012	0.94	0.96	0.04	0.19	0.025
ST	0.0033	1.25	2.05	0.17	1.24	0.063
% CV	-	2.1	1.0	2.3	1.0	0.9
n	80	80	80	80	80	80

High level	Na	Glu	Lac	tHb	sO ₂	COHb
Unit	mEq/L	mg/dL	mg/dL	g/dL	%	%
Mean	150	263.1	139.1	21.9	99.8	32.2
Sr	0.3	3.39	3.39	0.13	0.09	0.05
ST	0.7	11.66	11.98	0.16	0.13	0.29
% CV	0.5	4.4	8.6	0.7	0.1	0.9
n	80	80	80	80	80	80

High level	MetHb	HHb	O ₂ Hb	HbF	ctBil*	
Unit	%	%	%	%	mg/dL	
Mean	10.0	23.7	96.5	60.2	30.3	
Sr	0.06	0.17	0.12	2.78	0.086	
ST	0.23	0.29	0.20	6.39	0.497	
% CV	2.3	1.2	0.2	10.6	1.6	
n	80	80	80	80	80	

* Bilirubin can only be measured on neonatal samples. This parameter is only available in the Neonate blood analysis 65 µL mode.

ABL90 FLEX precision - syringe study - site 5

Low level	pH	pCO ₂	pO ₂	Ca	Cl	K
Unit		mmHg	mmHg	mg/dL	mEq/L	mEq/L
Mean	7.273	27.7	43.9	2.23	94	-
Sr	0.0020	0.62	0.26	0.01	0.25	-
ST	0.0044	0.65	0.56	0.05	1.17	-
% CV	-	2.4	1.3	2.0	1.2	-
n	80	80	80	80	80	-

Low level	Na	Glu	Lac	tHb	sO ₂	COHb
Unit	mEq/L	mg/dL	mg/dL	g/dL	%	%
Mean	120	14.1	-	3.8	73.5	-
Sr	0.3	0.49	-	0.07	0.21	-
ST	0.6	0.97	-	0.11	0.41	-
% CV	0.5	6.8	-	2.9	0.6	-
n	80	80	-	80	80	-

Low level	MetHb	HHb	O ₂ Hb	HbF	ctBil*	
Unit	%	%	%	%	mg/dL	

Low level	MetHb	HHb	O ₂ Hb	HbF	ctBil*	
Mean	-	-	71.9	-	2.2	
Sr	-	-	0.16	-	0.065	
ST	-	-	0.62	-	0.107	
% CV	-	-	0.9	-	4.9	
n	-	-	80	-	80	

Medium level	pH	pCO ₂	pO ₂	Ca	Cl	K
Unit		mmHg	mmHg	mg/dL	mEq/L	mEq/L
Mean	7.375	40.8	76.7	4.83	109	4.69
Sr	0.0011	0.74	0.70	0.04	0.50	0.022
ST	0.0035	0.94	0.98	0.09	1.74	0.049
% CV	-	2.3	1.3	1.8	1.6	1.0
n	80	80	80	80	80	80

Medium level	Na	Glu	Lac	tHb	sO ₂	COHb
Unit	mEq/L	mg/dL	mg/dL	g/dL	%	%
Mean	141	102.6	19.2	15.1	93.4	3.0
Sr	0.4	0.85	0.61	0.07	0.15	0.00
ST	0.8	3.00	1.33	0.14	0.34	0.24
% CV	0.6	2.9	6.9	0.9	0.4	8.0
n	80	80	80	80	80	80

Medium level	MetHb	HHb	O ₂ Hb	HbF	ctBil*	
Unit	%	%	%	%	mg/dL	
Mean	3.4	6.4	90.9	36.6	7.6	
Sr	0.07	0.14	0.39	1.95	0.072	
ST	0.19	0.33	0.50	4.25	0.125	
% CV	5.5	5.2	0.5	11.6	1.6	
n	80	80	76	76	80	

High level	pH	pCO ₂	pO ₂	Ca	Cl	K
Unit		mmHg	mmHg	mg/dL	mEq/L	mEq/L
Mean	7.475	60.1	205.0	7.57	122	6.62
Sr	0.0012	1.05	0.54	0.03	0.19	0.019
ST	0.0068	1.14	2.12	0.11	0.99	0.059

High level	pH	pCO ₂	pO ₂	Ca	Cl	K
% CV	-	1.9	1.0	1.4	0.8	0.9
n	80	80	80	80	80	80

High level	Na	Glu	Lac	tHb	sO ₂	COHb
Unit	mEq/L	mg/dL	mg/dL	g/dL	%	%
Mean	151	277.2	147.5	21.9	99.6	39.7
Sr	0.3	1.88	3.34	0.11	0.10	0.00
ST	0.7	5.51	17.34	0.13	0.13	0.22
% CV	0.5	2.0	11.8	0.6	0.1	0.5
n	80	80	80	80	80	80

High level	MetHb	HHb	O ₂ Hb	HbF	ctBil*	
Unit	%	%	%	%	mg/dL	
Mean	10.6	25.8	97.7	61.7	31.6	
Sr	0.06	0.22	0.17	1.79	0.277	
ST	0.24	0.25	0.21	5.60	0.409	
% CV	2.2	1.0	0.2	9.1	1.3	
n	80	80	80	80	80	

* Bilirubin can only be measured on neonatal samples. This parameter is only available in the Neonate blood analysis 65 µL mode.

ABL90 FLEX precision - syringe study - pooled data

Pooled data from site 1, 3 and 5.

Low level	pH	pCO ₂	pO ₂	Ca	Cl	K
Unit		mmHg	mmHg	mg/dL	mEq/L	mEq/L
Mean	7.272	28.0	44.5	2.30	94	-
Sr	0.0019	0.55	0.21	0.01	0.21	-
ST	0.0037	0.67	0.68	0.07	1.08	-
% CV	-	2.4	1.5	3.1	1.2	-
n	240	240	240	240	240	-

Low level	Na	Glu	Lac	tHb	sO ₂	COHb
Unit	mEq/L	mg/dL	mg/dL	g/dL	%	%
Mean	119	13.2	-	3.8	75.1	-
Sr	0.3	0.52	-	0.06	0.24	-
ST	0.6	1.16	-	0.09	0.38	-

Low level	Na	Glu	Lac	tHb	sO ₂	COHb
% CV	0.5	8.8	-	2.2	0.5	-
n	240	240	-	240	240	-

Low level	MetHb	HHb	O ₂ Hb	HbF	ctBil*	
Unit	%	%	%	%	mg/dL	
Mean	-	-	72.4	-	2.1	
Sr	-	-	0.23	-	0.058	
ST	-	-	0.46	-	0.097	
% CV	-	-	0.6	-	4.6	
n	-	-	240	-	240	

Medium level	pH	pCO ₂	pO ₂	Ca	Cl	K
Unit		mmHg	mmHg	mg/dL	mEq/L	mEq/L
Mean	7.370	41.6	76.1	4.84	108	4.75
Sr	0.0012	0.64	0.70	0.03	0.35	0.034
ST	0.0034	0.86	1.12	0.08	1.42	0.065
% CV	-	2.1	1.5	1.7	1.3	1.4
n	240	240	240	240	240	240

Medium level	Na	Glu	Lac	tHb	sO ₂	COHb
Unit	mEq/L	mg/dL	mg/dL	g/dL	%	%
Mean	141	98.3	19.1	15.0	93.1	3.2
Sr	0.4	0.72	0.51	0.09	0.14	0.05
ST	0.7	3.18	1.20	0.13	0.34	0.21
% CV	0.5	3.2	6.3	0.9	0.4	6.6
n	240	240	240	240	240	240

Medium level	MetHb	HHb	O ₂ Hb	HbF	ctBil*	
Unit	%	%	%	%	mg/dL	
Mean	3.4	6.7	90.5	40.7	7.4	
Sr	0.07	0.14	0.27	1.93	0.062	
ST	0.17	0.31	0.35	4.98	0.110	
% CV	5.0	4.6	0.4	12.2	1.5	
n	240	240	236	236	240	

High level	pH	pCO ₂	pO ₂	Ca	Cl	K
Unit		mmHg	mmHg	mg/dL	mEq/L	mEq/L
Mean	7.472	60.3	204.3	7.57	122	6.63
Sr	0.0011	0.96	1.43	0.03	0.20	0.022
ST	0.0047	1.43	2.66	0.13	1.03	0.059
% CV	-	2.4	1.3	1.8	0.8	0.9
n	240	240	240	240	240	240

High level	Na	Glu	Lac	tHb	sO ₂	COHb
Unit	mEq/L	mg/dL	mg/dL	g/dL	%	%
Mean	151	264.3	144.3	21.7	99.7	38.0
Sr	0.3	2.56	3.60	0.11	0.09	0.06
ST	0.7	8.77	13.13	0.15	0.17	0.24
% CV	0.5	3.3	9.1	0.7	0.2	0.6
n	240	240	240	240	240	240

High level	MetHb	HHb	O ₂ Hb	HbF	ctBil*	
Unit	%	%	%	%	mg/dL	
Mean	10.1	24.3	97.2	63.8	30.7	
Sr	0.06	0.21	0.15	3.80	0.205	
ST	0.23	0.32	0.20	6.84	0.404	
% CV	2.3	1.3	0.2	10.7	1.3	
n	240	240	240	240	240	

* Bilirubin can only be measured on neonatal samples. This parameter is only available in the Neonate blood analysis 65 µL mode.

ABL90 FLEX Precision - capillary study - site 1

Low level	pH	pCO ₂	pO ₂	Ca	Cl	K
Unit		mmHg	mmHg	mg/dL	mEq/L	mEq/L
Mean	7.265	28.0	45.3	2.27	93	-
Sr	0.0021	0.44	0.35	0.10	0.30	-
ST	0.0044	0.65	0.89	0.13	0.91	-
% CV	-	2.3	2.0	5.6	1.0	-
n	80	80	80	80	80	-

Low level	Na	Glu	Lac	tHb	sO ₂	COHb
Unit	mEq/L	mg/dL	mg/dL	g/dL	%	%

Low level	Na	Glu	Lac	tHb	sO ₂	COHb
Mean	121	14	-	3.7	77.3	-
Sr	0.4	0.53	-	0.04	0.24	-
ST	0.7	1.54	-	0.07	0.59	-
% CV	0.6	10.9	-	2.0	0.8	-
n	80	80	-	80	80	-

Low level	MetHb	HHb	O ₂ Hb	HbF	ctBil*	
Unit	%	%	%	%	mg/dL	
Mean	-	-	75.4	-	2.1	
Sr	-	-	0.31	-	0.047	
ST	-	-	0.44	-	0.087	
% CV	-	-	0.6	-	4.2	
n	-	-	80	-	80	

Medium level	pH	pCO ₂	pO ₂	Ca	Cl	K
Unit		mmHg	mmHg	mg/dL	mEq/L	mEq/L
Mean	7.372	42.2	77.6	4.83	108	4.86
Sr	0.0018	0.49	0.99	0.03	0.42	0.043
ST	0.0064	0.81	1.46	0.07	1.45	0.114
% CV	-	1.9	1.9	1.5	1.3	2.4
n	80	80	80	80	80	80

Medium level	Na	Glu	Lac	tHb	sO ₂	COHb
Unit	mEq/L	mg/dL	mg/dL	g/dL	%	%
Mean	141	96	19	14.9	93.2	3.4
Sr	0.4	1.60	0.62	0.10	0.18	0.00
ST	0.9	3.33	1.05	0.23	0.36	0.19
% CV	0.7	3.4	5.5	1.5	0.4	5.7
n	80	80	80	80	80	80

Medium level	MetHb	HHb	O ₂ Hb	HbF	ctBil*	
Unit	%	%	%	%	mg/dL	
Mean	3.0	6.6	90.8	46.0	7.3	
Sr	0.08	0.24	0.20	2.59	0.087	
ST	0.18	0.44	0.31	5.74	0.109	

Medium level	MetHb	HHb	O ₂ Hb	HbF	ctBil*	
% CV	6.0	6.7	0.3	12.5	1.5	
n	80	80	80	80	80	

High level	pH	pCO ₂	pO ₂	Ca	Cl	K
Unit		mmHg	mmHg	mg/dL	mEq/L	mEq/L
Mean	7.470	61.5	206.3	7.61	121	6.57
Sr	0.0027	0.75	2.38	0.12	0.39	0.034
ST	0.0044	1.13	4.72	0.20	1.01	0.070
% CV	-	1.8	2.3	2.6	0.8	1.1
n	80	80	80	80	80	80

High level	Na	Glu	Lac	tHb	sO ₂	COHb
Unit	mEq/L	mg/dL	mg/dL	g/dL	%	%
Mean	151	277	144	21.3	99.9	38.1
Sr	0.4	3.09	2.67	0.14	0.10	0.00
ST	1.0	11.0	9.3	0.21	0.20	0.16
% CV	0.7	4.0	6.5	1.0	0.2	0.4
n	80	80	80	80	80	80

High level	MetHb	HHb	O ₂ Hb	HbF	ctBil*	
Unit	%	%	%	%	mg/dL	
Mean	9.6	23.2	97.5	68.9	30.3	
Sr	0.13	0.24	0.20	2.48	0.367	
ST	0.22	0.41	0.24	5.90	0.343	
% CV	2.3	1.8	0.2	8.6	1.1	
n	80	80	80	80	80	

* Bilirubin can only be measured on neonatal samples. This parameter is only available in the Neonate blood analysis 65 µL mode.

ABL90 FLEX precision - capillary study - site 3

Low level	pH	pCO ₂	pO ₂	Ca	Cl	K
Unit		mmHg	mmHg	mg/dL	mEq/L	mEq/L
Mean	7.280	28.2	45.3	2.40	94	-
Sr	0.0025	0.64	0.58	0.05	0.39	-
ST	0.0034	0.69	1.00	0.11	1.24	-

Low level	pH	pCO ₂	pO ₂	Ca	Cl	K
% CV	-	2.4	2.2	4.5	1.3	-
n	80	80	80	80	80	-

Low level	Na	Glu	Lac	tHb	sO ₂	COHb
Unit	mEq/L	mg/dL	mg/dL	g/dL	%	%
Mean	119	14	-	3.8	75.5	-
Sr	0.3	0.60	-	0.08	0.25	-
ST	0.7	1.58	-	0.08	0.38	-
% CV	0.6	11.4	-	2.1	0.5	-
n	80	80	-	80	80	-

Low level	MetHb	HHb	O ₂ Hb	HbF	ctBil*	
Unit	%	%	%	%	mg/dL	
Mean	-	-	72.6	-	2.1	
Sr	-	-	0.25	-	0.037	
ST	-	-	0.40	-	0.076	
% CV	-	-	0.6	-	3.7	
n	-	-	80	-	80	

Medium level	pH	pCO ₂	pO ₂	Ca	Cl	K
Unit		mmHg	mmHg	mg/dL	mEq/L	mEq/L
Mean	7.375	41.7	75.4	4.88	108	4.68
Sr	0.0020	0.73	0.78	0.03	0.37	0.035
ST	0.0036	0.83	1.32	0.10	1.51	0.070
% CV	-	2.0	1.8	2.1	1.4	1.5
n	80	80	80	80	80	80

Medium level	Na	Glu	Lac	tHb	sO ₂	COHb
Unit	mEq/L	mg/dL	mg/dL	g/dL	%	%
Mean	141	99	19	15.2	93.5	3.3
Sr	0.4	1.05	0.67	0.15	0.16	0.04
ST	1.1	2.77	1.18	0.15	0.35	0.21
% CV	0.8	2.8	6.1	1.0	0.4	6.4
n	80	80	80	80	80	80

Medium level	MetHb	HHb	O ₂ Hb	HbF	ctBil*	
Unit	%	%	%	%	mg/dL	
Mean	3.7	6.5	85.7	42.1	7.3	
Sr	0.09	0.24	0.29	2.06	0.059	
ST	0.36	0.39	0.37	6.16	0.095	
% CV	9.8	6.1	0.4	14.6	1.3	
n	80	80	80	80	80	

High level	pH	pCO ₂	pO ₂	Ca	Cl	K
Unit		mmHg	mmHg	mg/dL	mEq/L	mEq/L
Mean	7.471	59.9	201.6	7.53	124	6.74
Sr	0.0020	1.11	1.23	0.13	0.22	0.039
ST	0.0024	1.38	2.53	0.27	1.78	0.073
% CV	-	2.3	1.3	3.6	1.4	1.1
n	80	80	80	80	80	80

High level	Na	Glu	Lac	tHb	sO ₂	COHb
Unit	mEq/L	mg/dL	mg/dL	g/dL	%	%
Mean	151	263	139	21.9	99.8	32.2
Sr	0.3	3.73	3.54	0.19	0.08	0.06
ST	0.9	10.7	11.9	0.22	0.11	0.30
% CV	0.6	4.1	8.5	1.0	0.1	0.9
n	80	80	80	80	80	80

High level	MetHb	HHb	O ₂ Hb	HbF	ctBil*	
Unit	%	%	%	%	mg/dL	
Mean	9.9	24.1	96.5	60.6	30.2	
Sr	0.10	0.24	0.18	1.94	0.186	
ST	0.23	0.38	0.24	5.67	0.492	
% CV	2.3	1.6	0.3	9.4	1.6	
n	80	80	80	80	80	

* Bilirubin can only be measured on neonatal samples. This parameter is only available in the Neonate blood analysis 65 µL mode.

ABL90 FLEX precision - capillary study - site 5

Low level	pH	pCO ₂	pO ₂	Ca	Cl	K
Unit		mmHg	mmHg	mg/dL	mEq/L	mEq/L
Mean	7.267	27.6	43.8	2.22	94	-
Sr	0.0028	0.68	0.36	0.06	0.25	-
ST	0.0051	0.65	0.83	0.07	1.12	-
% CV	-	2.4	1.9	3.2	1.2	-
n	80	80	80	80	80	-

Low level	Na	Glu	Lac	tHb	sO ₂	COHb
Unit	mEq/L	mg/dL	mg/dL	g/dL	%	%
Mean	120	14	-	3.7	75.0	-
Sr	0.2	0.53	-	0.04	0.26	-
ST	0.6	1.48	-	0.06	0.46	-
% CV	0.5	10.4	-	1.6	0.6	-
n	80	80	-	80	80	-

Low level	MetHb	HHb	O ₂ Hb	HbF	ctBil*	
Unit	%	%	%	%	mg/dL	
Mean	-	-	74.4	-	2.2	
Sr	-	-	0.19	-	0.050	
ST	-	-	0.66	-	0.080	
% CV	-	-	0.9	-	3.6	
n	-	-	80	-	80	

Medium level	pH	pCO ₂	pO ₂	Ca	Cl	K
Unit		mmHg	mmHg	mg/dL	mEq/L	mEq/L
Mean	7.377	40.8	76.9	4.83	109	4.72
Sr	0.0027	0.65	0.48	0.04	0.27	0.039
ST	0.0042	0.98	1.58	0.09	1.32	0.082
% CV	-	2.4	2.1	1.8	1.2	1.7
n	80	80	80	80	80	80

Medium level	Na	Glu	Lac	tHb	sO ₂	COHb
Unit	mEq/L	mg/dL	mg/dL	g/dL	%	%
Mean	141	101	19	15.0	93.4	3.1

Medium level	Na	Glu	Lac	tHb	sO ₂	COHb
Sr	0.5	0.99	0.56	0.11	0.16	0.00
ST	0.8	3.07	1.24	0.33	0.35	0.24
% CV	0.5	3.0	6.5	2.2	0.4	7.9
n	80	80	80	80	80	80

Medium level	MetHb	HHb	O ₂ Hb	HbF	ctBil*	
Unit	%	%	%	%	mg/dL	
Mean	3.4	6.7	90.9	37.0	7.5	
Sr	0.10	0.16	0.18	2.45	0.104	
ST	0.16	0.33	0.35	4.54	0.131	
% CV	4.5	5.0	0.4	12.3	1.7	
n	80	80	80	80	80	

High level	pH	pCO ₂	pO ₂	Ca	Cl	K
Unit		mmHg	mmHg	mg/dL	mEq/L	mEq/L
Mean	7.477	60.1	207.6	7.57	122	6.62
Sr	0.0034	0.71	1.97	0.10	0.30	0.034
ST	0.0074	0.99	3.37	0.20	1.01	0.068
% CV	-	1.6	1.6	2.6	0.8	1.0
n	80	80	80	80	80	80

High level	Na	Glu	Lac	tHb	sO ₂	COHb
Unit	mEq/L	mg/dL	mg/dL	g/dL	%	%
Mean	151	276	147	21.7	99.7	41.7
Sr	0.4	2.95	3.04	0.14	0.09	0.00
ST	0.7	9.5	10.4	0.20	0.16	0.25
% CV	0.5	3.4	7.1	0.9	0.2	0.6
n	80	80	80	80	80	80

High level	MetHb	HHb	O ₂ Hb	HbF	ctBil*	
Unit	%	%	%	%	mg/dL	
Mean	10.5	24.1	97.5	62.4	31.3	
Sr	0.06	0.19	0.11	2.74	0.384	
ST	0.21	0.60	0.21	4.98	0.404	
% CV	2.0	2.5	0.2	8.0	1.3	

High level	MethHb	HHb	O ₂ Hb	HbF	ctBil*	
n	80	80	80	80	80	

* Bilirubin can only be measured on neonatal samples. This parameter is only available in the Neonate blood analysis 65 µL mode

ABL90 FLEX precision - capillary study - pooled data

Pooled data for site 1, 3 and 5.

Low level	pH	pCO ₂	pO ₂	Ca	Cl	K
Unit		mmHg	mmHg	mg/dL	mEq/L	mEq/L
Mean	7.271	27.9	44.8	2.30	94	-
Sr	0.0025	0.59	0.44	0.07	0.32	-
ST	0.0044	0.67	0.91	0.10	1.10	-
% CV	-	2.4	2.0	4.6	1.2	-
n	240	240	240	240	240	-

Low level	Na	Glu	Lac	tHb	sO ₂	COHb
Unit	mEq/L	mg/dL	mg/dL	g/dL	%	%
Mean	120	14	-	3.7	75.9	-
Sr	0.3	0.56	-	0.06	0.25	-
ST	0.7	1.53	-	0.07	0.48	-
% CV	0.6	10.9	-	1.9	0.6	-
n	240	240	-	240	240	-

Low level	MethHb	HHb	O ₂ Hb	HbF	ctBil*	
Unit	%	%	%	%	mg/dL	
Mean	-	-	74.1	-	2.1	
Sr	-	-	0.25	-	0.045	
ST	-	-	0.52	-	0.081	
% CV	-	-	0.7	-	3.8	
n	-	-	240	-	240	

Medium level	pH	pCO ₂	pO ₂	Ca	Cl	K
Unit		mmHg	mmHg	mg/dL	mEq/L	mEq/L
Mean	7.375	41.5	76.6	4.85	108	4.75
Sr	0.0022	0.63	0.78	0.03	0.36	0.039
ST	0.0049	0.88	1.45	0.09	1.43	0.091

Medium level	pH	pCO ₂	pO ₂	Ca	Cl	K
% CV	-	2.1	1.9	1.9	1.3	1.9
n	240	240	240	240	240	240

Medium level	Na	Glu	Lac	tHb	sO ₂	COHb
Unit	mEq/L	mg/dL	mg/dL	g/dL	%	%
Mean	141	99	19	15.0	93.4	3.2
Sr	0.4	1.24	0.6	0.12	0.17	0.03
ST	0.9	3.06	1.16	0.25	0.35	0.22
% CV	0.7	3.1	6.1	1.6	0.4	6.7
n	240	240	240	240	240	240

Medium level	MetHb	HHb	O ₂ Hb	HbF	ctBil*	
Unit	%	%	%	%	mg/dL	
Mean	3.4	6.6	89.1	41.7	7.4	
Sr	0.09	0.22	0.23	2.38	0.085	
ST	0.25	0.39	0.34	5.52	0.113	
% CV	7.4	6.0	0.4	13.2	1.5	
n	240	240	240	240	240	

High level	pH	pCO ₂	pO ₂	Ca	Cl	K
Unit		mmHg	mmHg	mg/dL	mEq/L	mEq/L
Mean	7.473	60.5	205.2	7.57	122	6.64
Sr	0.0027	0.87	1.92	0.12	0.31	0.035
ST	0.0052	1.18	3.65	0.22	1.32	0.070
% CV	-	1.9	1.8	2.9	1.1	1.1
n	240	240	240	240	240	240

High level	Na	Glu	Lac	tHb	sO ₂	COHb
Unit	mEq/L	mg/dL	mg/dL	g/dL	%	%
Mean	151	272	143	21.6	99.8	37.3
Sr	0.4	3.27	3.1	0.16	0.09	0.03
ST	0.9	10.4	10.6	0.21	0.16	0.24
% CV	0.6	3.8	7.4	1.0	0.2	0.7
n	240	240	240	240	240	240

High level	MethHb	HHb	O ₂ Hb	HbF	ctBil*	
Unit	%	%	%	%	mg/dL	
Mean	10.0	23.8	97.1	64.0	30.6	
Sr	0.10	0.22	0.17	2.41	0.325	
ST	0.22	0.47	0.23	5.53	0.417	
% CV	2.2	2.0	0.2	8.6	1.4	
n	240	240	240	240	240	

*Bilirubin can only be measured on neonatal samples. This parameter is only available in the Neonate blood analysis 65 µL mode.

Method comparison studies with predicate devices

Study design

Method comparison studies were performed at six user sites. The sites were not the same for all the parameters and the measurements were not performed at the same time. Some of the results derive from measurements started at different times and at different sites. The purpose was to evaluate whether the ABL90 FLEX analyzer is a suitable replacement for a current test method for each of the parameters measured by the analyzer (pH, pCO₂, pO₂, cCa²⁺, cCl⁻, cK⁺, cNa⁺, cGlu, cLac, ctBil*, ctHb, sO₂, FO₂Hb, FHHb, FCOHb, FMetHb, FHbF).

time.

The studies were conducted in a point-of-care setting and methods described in NCCLS were used. "Method Comparison and Bias Estimation Using Patient Samples; Approved Guideline – Second Edition", NCCLS EP9-A2. [12]

The material used was random patient samples and spiked blood samples. Spiked samples were needed to support the full reportable range. In each study sample handling and sample transfer was done by multiple POC staff members. The studies were done in both syringe mode and capillary mode of the ABL90 FLEX analyzer.

*Bilirubin can only be measured on neonatal samples. This parameter is only available in the Neonate blood analysis 65 µL mode.

ABL90 FLEX method comparison study results - syringe mode - site 1

Predicate device: Radiometer ABL735 analyzer.

A spiked sample is a sample that has been prepared by Radiometer. That means that the sample may or may not have been spiked with the specific parameter.

Parameter	Units	Range Low	Range High	Total n	Spiked n	Slope	Intercept	R ²	S _{y.x}
pH	N/A	6.859	7.692	244	114	1.02	-0.17	0.9926	0.009
pCO ₂	kPa	2.11	12.3	231	101	0.99	0.02	0.9942	0.13
	mmHg	15.8	92.3	231	101	0.99	0.18	0.9942	0.96
pO ₂	kPa	4.1	63.7	208	95	1.06	-0.40	0.9978	0.48
	mmHg	30.8	477.8	208	95	1.06	-3.02	0.9978	3.59

Parameter	Units	Range Low	Range High	Total n	Spiked n	Slope	Intercept	R ²	S _{y,x}
cCa ²⁺	mg/dL	2.00	9.80	247	121	1.08	-0.24	0.9940	0.08
	mEq/L	1.00	4.90	247	121	1.08	-0.12	0.9940	0.04
	mmol/L	0.50	2.45	247	121	1.08	-0.06	0.9940	0.02
cCl ⁻	mEq/L	86	149	225	96	1.02	-2.35	0.9862	1.01
	mmol/L	86	149	225	96	1.02	-2.35	0.9862	1.01
cK ⁺	mEq/L	2.7	10.5	253	123	1.00	0.13	0.9971	0.06
	mmol/L	2.7	10.5	253	123	1.00	0.13	0.9971	0.06
cNa ⁺	mEq/L	116	176	255	125	1.07	-8.06	0.9941	0.69
	mmol/L	116	176	255	125	1.07	-8.06	0.9941	0.69
cGlu	mg/dL	11	648	245	117	0.91	2.62	0.9912	7.75
	mmol/L	0.6	36.0	245	117	0.91	0.15	0.9912	0.43
cLac	mg/dL	5	171	251	123	0.75	4.60	0.9667	4.87
	mmol/L	0.5	19.0	251	123	0.75	0.51	0.9667	0.54
ctBil*	mg/dL	2.8	36.9	85	9	0.992	0.36	0.989	0.651
	μmol/L	48	631	85	9	0.992	6.2	0.989	11.1
ctHb	g/dL	1.0	23.8	249	119	0.95	0.35	0.9929	0.29
sO ₂	%	6.1	99.9	233	103	1.02	-2.09	0.9984	0.65
FHHb	%	2.4	98.5	157	77	1.01	0.78	0.9988	0.70
FO ₂ Hb	%	6.0	98.0	232	103	1.01	-1.44	0.9980	0.77
FCOHb	%	1.0	80.3	218	95	1.00	0.07	0.9986	0.32
FMetHb	%	1.0	76.3	163	39	1.00	-0.01	0.9985	0.34
FHbF	%	33	62	7	7	1.05	-7.18	0.6885	6.23

*Bilirubin can only be measured on neonatal samples. This parameter is only available in the Neonate blood analysis 65 μL mode. Predicate device: ABL835 FLEX analyzer.

ABL90 FLEX method comparison study results - syringe mode - site 2

Predicate device: Radiometer ABL835 analyzer.

A spiked sample is a sample that has been prepared by Radiometer. That means that the sample may or may not have been spiked with the specific parameter.

Parameter	Units	Range Low	Range High	Total n	Spiked n	Slope	Intercept	R ²	S _{y,x}
pH	N/A	6.840	7.774	199	95	1.04	-0.28	0.9925	0.011
pCO ₂	kPa	2.2	12.0	193	89	1.04	-0.15	0.9938	0.12
	mmHg	16.2	90.0	193	89	1.04	-1.12	0.9938	0.89

Parameter	Units	Range Low	Range High	Total n	Spiked n	Slope	Intercept	R ²	S _{y,x}
pO ₂	kPa	4.0	59.9	178	80	1.03	-0.53	0.9988	0.28
	mmHg	30.1	449.3	178	80	1.03	-3.97	0.9988	2.07
cCa ²⁺	mg/dL	2.20	9.88	195	93	1.12	-0.44	0.9950	0.08
	mEq/L	1.10	4.94	195	93	1.12	-0.22	0.9950	0.04
	mmol/L	0.55	2.47	195	93	1.12	-0.11	0.9950	0.02
cCl ⁻	mEq/L	86	146	190	87	1.02	-3.75	0.9765	1.20
	mmol/L	86	146	190	87	1.02	-3.75	0.9765	1.20
cK ⁺	mEq/L	2.3	10.3	193	90	0.99	0.25	0.9938	0.09
	mmol/L	2.3	10.3	193	90	0.99	0.25	0.9938	0.09
cNa ⁺	mEq/L	119	180	195	93	1.05	-4.13	0.9878	1.01
	mmol/L	119	180	195	93	1.05	-4.13	0.9878	1.01
cGlu	mg/dL	18	630	194	95	0.98	-4.97	0.9986	3.44
	mmol/L	1.0	35.0	194	95	0.98	-0.28	0.9986	0.19
cLac	mg/dL	4	216	203	100	0.91	-0.55	0.9966	1.77
	mmol/L	0.4	24.0	203	100	0.91	-0.06	0.9966	0.20
ctBil*	mg/dL	0.8	35.9	51	8	1.005	0.37	0.992	0.784
	μmol/L	14	614	51	8	1.005	6.4	0.992	13.4
ctHb	g/dL	4.8	23.8	200	96	0.96	0.32	0.9968	0.16
sO ₂	%	12.1	99.6	196	92	0.99	0.59	0.9982	0.72
FHHb	%	2.4	98.5	143	77	0.99	-0.04	0.9981	0.82
FO ₂ Hb	%	10.9	97.9	197	93	0.99	0.51	0.9986	0.72
FCOHb	%	1.0	88.5	190	91	1.00	0.21	0.9995	0.26
FMetHb	%	1.0	66.7	10	6	0.99	0.18	0.9999	0.25
FHbF	%	21	78	15	15	1.02	-3.83	0.9553	4.30

*Bilirubin can only be measured on neonatal samples. This parameter is only available in the Neonate blood analysis 65 μL mode.

ABL90 FLEX method comparison study results - syringe mode - site 3

Predicate device: Radiometer ABL735 analyzer.

A spiked sample is a sample that has been prepared by Radiometer. That means that the sample may or may not have been spiked with the specific parameter.

Parameter	Units	Range Low	Range High	Total n	Spiked n	Slope	Intercept	R ²	S _{y,x}
pH	N/A	6.840	7.712	209	82	1.01	-0.10	0.9907	0.012

Parameter	Units	Range Low	Range High	Total n	Spiked n	Slope	Intercept	R ²	S _{y,x}
pCO ₂	kPa	2.1	13.1	212	85	0.98	0.06	0.9947	0.14
	mmHg	15.5	98.3	212	85	0.98	0.46	0.9947	1.02
pO ₂	kPa	4.1	65.0	202	76	1.02	-0.22	0.9992	0.28
	mmHg	30.6	487.5	202	76	1.02	-1.63	0.9992	2.10
cCa ²⁺	mg/dL	2.48	9.92	207	80	1.07	-0.18	0.9927	0.08
	mEq/L	1.24	4.96	207	80	1.07	-0.09	0.9927	0.04
	mmol/L	0.62	2.48	207	80	1.07	-0.05	0.9927	0.02
cCl ⁻	mEq/L	89	143	203	76	0.98	1.44	0.9776	1.18
	mmol/L	89	143	203	76	0.98	1.44	0.9776	1.18
cK ⁺	mEq/L	2.2	10.4	208	81	1.00	0.13	0.9972	0.06
	mmol/L	2.2	10.4	208	81	1.00	0.13	0.9972	0.06
cNa ⁺	mEq/L	119	179	207	80	1.03	-3.18	0.9923	0.70
	mmol/L	119	179	207	80	1.03	-3.18	0.9923	0.70
cGlu	mg/dL	16	702	216	89	0.98	-2.36	0.9987	3.00
	mmol/L	0.9	39.0	216	89	0.98	-0.13	0.9987	0.17
cLac	mg/dL	4	207	216	90	0.97	-0.47	0.9965	1.86
	mmol/L	0.4	23.0	216	90	0.97	-0.05	0.9965	0.21
ctBil*	mg/dL	1.2	35.7	74	8	0.992	1.021	0.986	0.864
	μmol/L	20	611	74	8	0.992	17.4	0.986	14.8
ctHb	g/dL	2.9	23.8	205	80	0.92	0.40	0.9921	0.31
sO ₂	%	6.6	100	197	75	1.00	-0.20	0.9992	0.50
FHHb	%	2.4	92.1	168	61	1.00	-0.04	0.9991	0.53
FO ₂ Hb	%	5.5	98.5	200	77	1.00	0.00	0.9991	0.57
FCOHb	%	1.0	89.3	188	66	1.00	0.35	0.9989	0.28
FMetHb	%	1.0	83.3	29	11	1.00	-0.09	0.9997	0.42
FHbF	%	40	76	8	8	0.99	7.61	0.8328	5.62

*Bilirubin can only be measured on neonatal samples. This parameter is only available in the Neonate blood analysis 65 μL mode.

ABL90 FLEX method comparison study results - syringe mode - pooled data

POC comparison test.

A spiked sample is a sample that has been prepared by Radiometer. That means that the sample may or may not have been spiked with the specific parameter.

Parameter	Units	Range Low	Range High	Total n	Spiked n	Slope	Intercept	R ²	S _{y,x}
pH	N/A	6.840	7.774	652	291	1.02	-0.18	0.9915	0.011
pCO ₂	kPa	2.1	13.1	636	275	0.99	0.04	0.9927	0.15
	mmHg	15.5	98.3	636	275	0.99	0.27	0.9927	1.09
pO ₂	kPa	4.0	65.0	588	251	1.04	-0.39	0.9979	0.43
	mmHg	30.1	487.5	588	251	1.04	-2.94	0.9979	3.25
cCa ²⁺	mg/dL	1.00	4.96	649	294	1.10	-0.15	0.9937	0.04
	mEq/L	0.50	2.48	649	294	1.10	-0.07	0.9937	0.02
	mmol/L	2.00	9.94	649	294	1.10	-0.30	0.9937	0.08
cCl ⁻	mEq/L	86	149	618	259	1.00	-0.86	0.9790	1.19
	mmol/L	86	149	618	259	1.00	-0.86	0.9790	1.19
cK ⁺	mEq/L	2.2	10.5	654	294	1.00	0.17	0.9949	0.08
	mmol/L	2.2	10.5	654	294	1.00	0.17	0.9949	0.08
cNa ⁺	mEq/L	116	180	657	298	1.05	-5.91	0.9906	0.85
	mmol/L	116	180	657	298	1.05	-5.91	0.9906	0.85
cGlu	mg/dL	11	702	655	301	0.96	-1.16	0.9943	6.48
	mmol/L	0.6	39.0	655	301	0.96	-0.06	0.9943	0.36
cLac	mg/dL	4	216	670	313	0.87	1.56	0.9748	4.66
	mmol/L	0.4	24.0	670	313	0.87	0.17	0.9748	0.52
ctBil*	mg/dL	0.8	36.9	210	26	0.990	0.657	0.988	0.814
	μmol/L	14	631	210	26	0.990	11.2	0.988	13.9
ctHb	g/dL	1.0	23.8	654	295	0.95	0.34	0.9914	0.31
sO ₂	%	6.1	100.0	626	270	1.00	-0.45	0.9981	0.75
FHHb	%	2.4	98.5	468	215	1.00	0.23	0.9980	0.84
FO ₂ Hb	%	5.5	98.5	629	273	1.00	-0.23	0.9983	0.75
FCO ₂ Hb	%	1.0	89.3	596	252	1.00	0.20	0.9989	0.31
FMetHb	%	1.0	83.3	202	56	1.00	-0.01	0.9993	0.35
FHbF	%	21	78	30	30	1.10	-5.28	0.8747	6.70

*Bilirubin can only be measured on neonatal samples. This parameter is only available in the Neonate blood analysis 65 μL mode.

Graphical presentation of POC comparison test results - syringe mode

Pooled data from the POC comparison test.

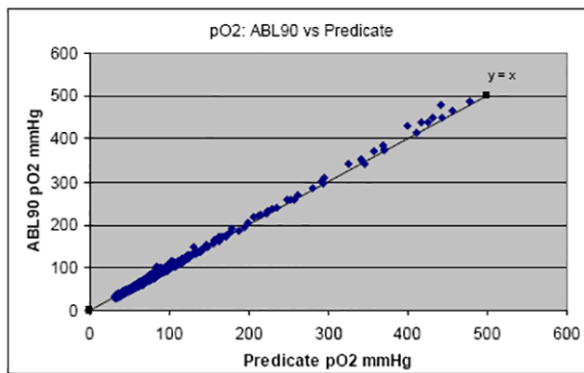
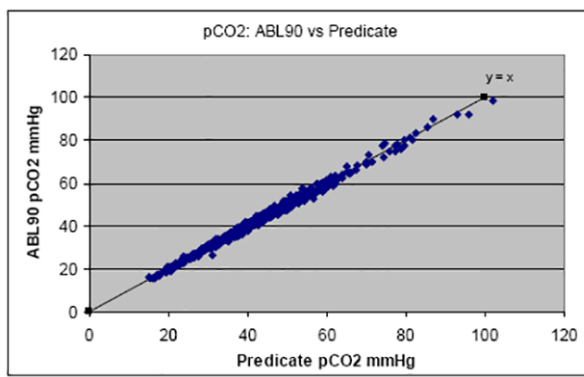
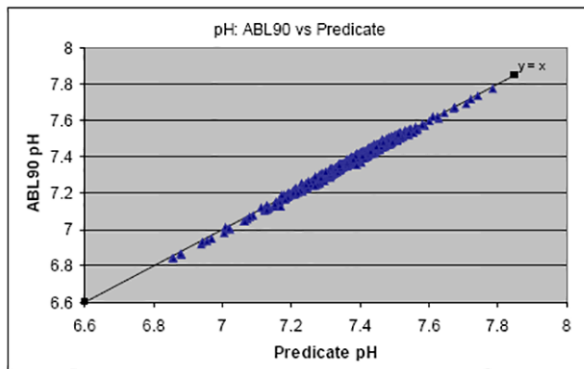

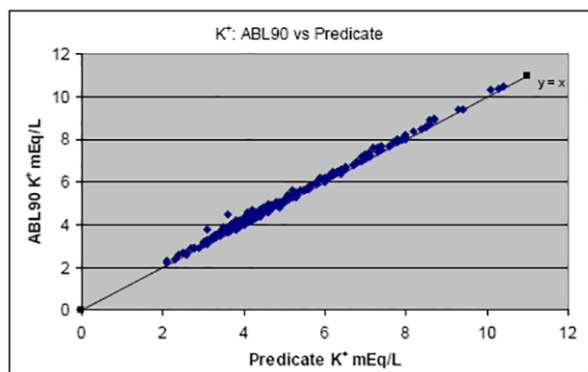
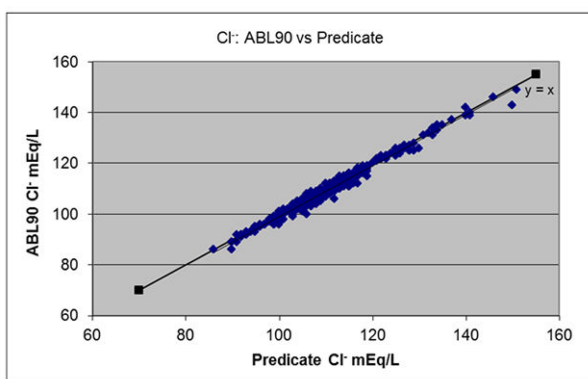
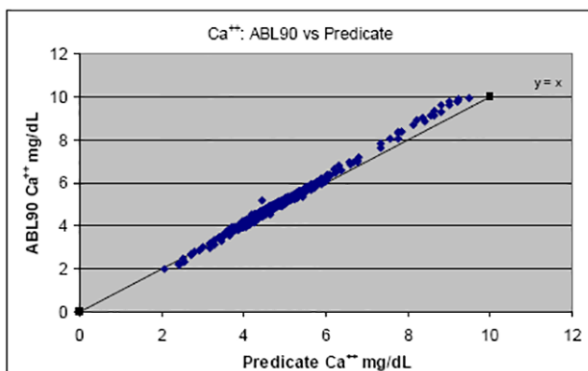

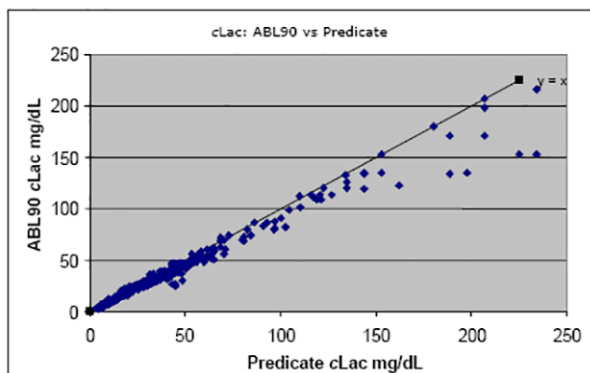
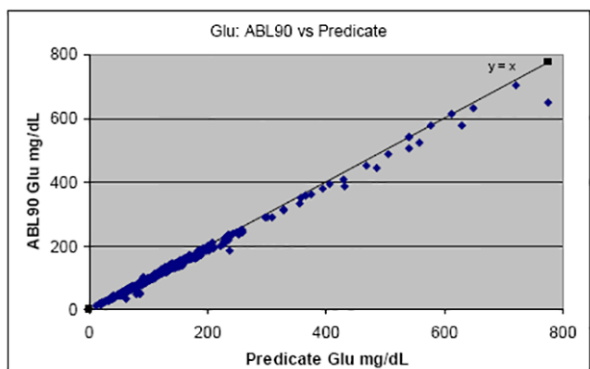
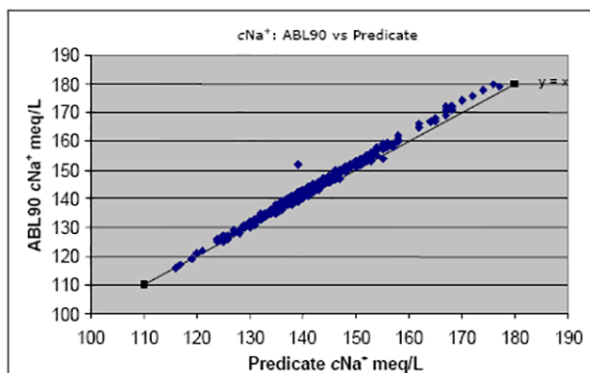

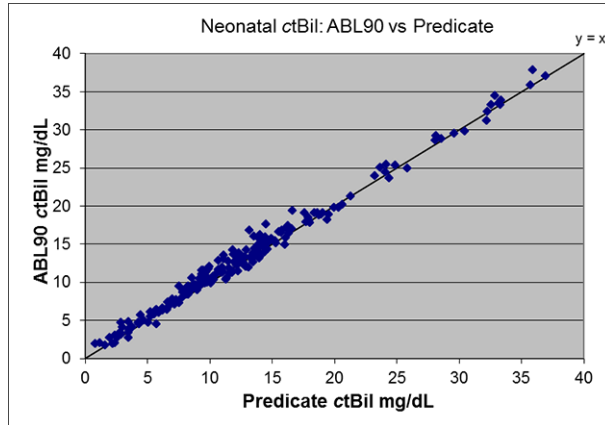

Bilirubin can only be measured on neonatal samples. This parameter is only available in the Neonate blood analysis 65 μ L mode.

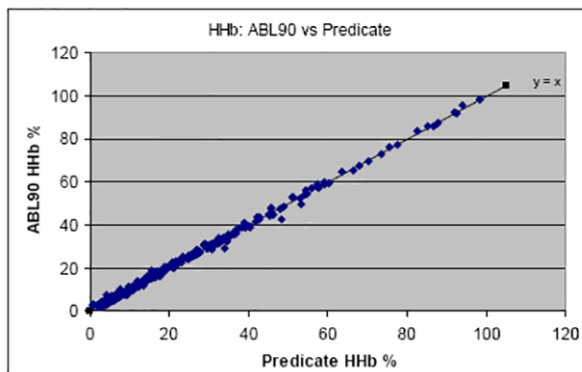
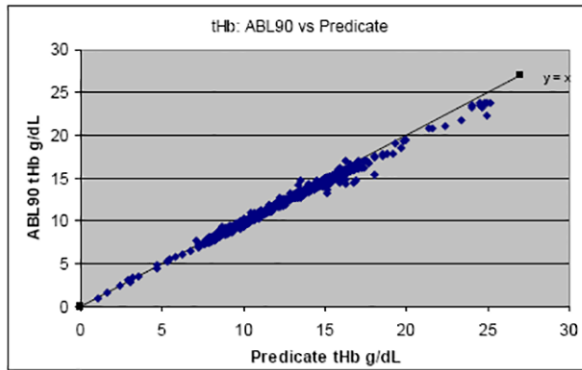

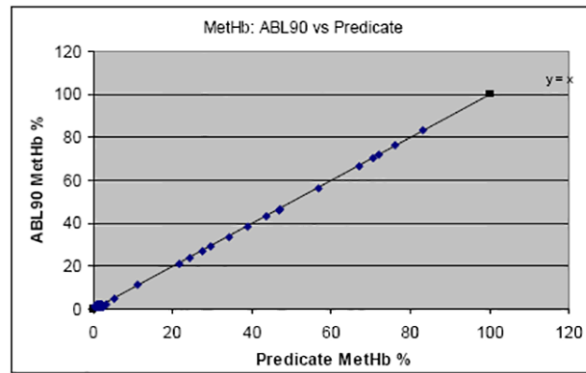
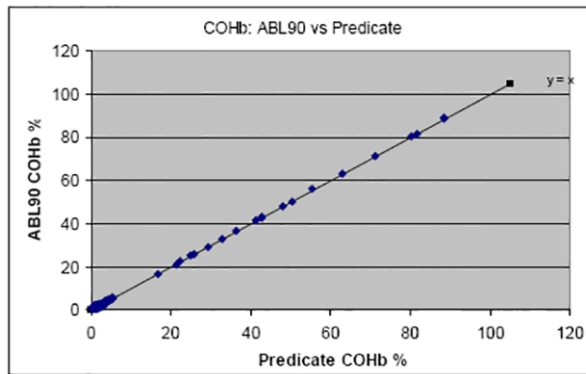
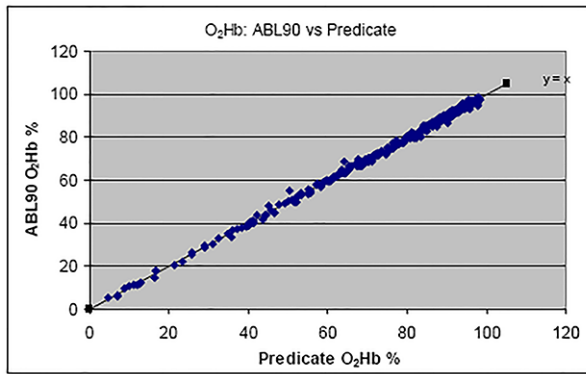

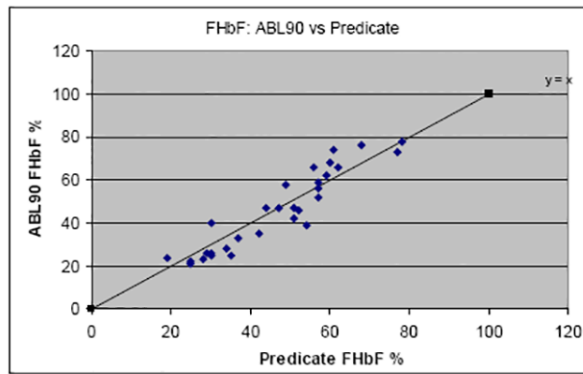
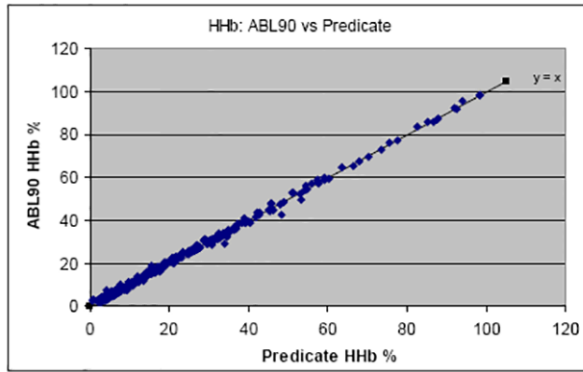

ABL90 FLEX method comparison study results - capillary mode - site 1

Predicate device: Radiometer ABL735 analyzer.

A spiked sample is a sample that has been prepared by Radiometer. That means that the sample may or may not have been spiked with the specific parameter.

Parameter	Units	Range Low	Range High	Total n	Spiked n	Slope	Intercept	R ²	S _{y.x}
pH	N/A	6.967	7.751	146	67	1.02	-0.14	0.9927	0.010
pCO ₂	kPa	2.11	12.80	152	73	1.01	-0.04	0.9970	0.11
	mmHg	15.8	96.0	152	73	1.01	-0.33	0.9970	0.84
pO ₂	kPa	4.07	62.10	147	69	1.00	0.02	0.9987	0.34
	mmHg	30.53	465.8	147	69	1.00	0.17	0.9987	2.58
cCa ²⁺	mg/dL	2.12	9.40	132	57	0.94	0.26	0.9691	0.13
	mEq/L	1.06	4.70	132	57	0.94	0.13	0.9691	0.06
	mmol/L	0.53	2.35	132	57	0.94	0.07	0.9691	0.03
cCl ⁻	mEq/L	86	150	147	69	1.00	-0.85	0.9829	1.29
	mmol/L	86	150	147	69	1.00	-0.85	0.9829	1.29

Parameter	Units	Range Low	Range High	Total n	Spiked n	Slope	Intercept	R ²	S _{y.x}
cK ⁺	mEq/L	2.1	9.9	148	71	0.99	-0.05	0.9984	0.05
	mmol/L	2.1	9.9	148	71	0.99	-0.05	0.9984	0.05
cNa ⁺	mEq/L	118	176	150	73	1.06	-7.66	0.9933	0.67
	mmol/L	118	176	150	73	1.06	-7.66	0.9933	0.67
cGlu	mg/dL	13	738	154	77	1.01	-2.42	0.9969	5.99
	mmol/L	0.7	41.0	154	77	1.01	-0.13	0.9969	0.33
cLac	mg/dL	4	180	148	75	1.02	-0.97	0.9795	4.13
	mmol/L	0.4	20.0	148	75	1.02	-0.11	0.9795	0.46
ctBil*	mg/dL	2.8	36.9	91	9	0.974	0.49	0.984	0.760
	μmol/L	48	631	91	9	0.974	8.3	0.984	13.0
ctHb	g/dL	0.6	24.0	153	76	1.00	0.25	0.9972	0.20
sO ₂	%	11.8	100	145	70	1.02	-2.75	0.9979	0.74
FHHb	%	2.5	97.1	102	54	1.01	0.95	0.9985	0.71
FO ₂ Hb	%	3.7	98.5	147	72	1.01	-0.59	0.9981	0.93
FCO ₂ Hb	%	1.0	92.2	78	39	1.01	-0.54	0.9992	0.46
FMetHb	%	1.0	89.4	69	16	1.01	-0.39	0.9993	0.44
FHbF	%	21	74	10	7	1.54	-17.2	0.9480	4.98

* Bilirubin can only be measured on neonatal samples. This parameter is only available in the Neonate blood analysis 65 μL mode. Predicate device: ABL835 FLEX analyzer.

ABL90 FLEX method comparison study results - capillary mode - site 2

Predicate device: Radiometer ABL735 analyzer.

A spiked sample is a sample that has been prepared by Radiometer. That means that the sample may or may not have been spiked with the specific parameter.

Parameter	Units	Range Low	Range High	Total n	Spiked n	Slope	Intercept	R ²	S _{y.x}
pH	N/A	6.824	7.763	150	74	0.98	0.18	0.9908	0.012
pCO ₂	kPa	2.12	12.8	147	70	0.93	0.19	0.9900	0.18
	mmHg	15.9	96.0	147	70	0.93	1.42	0.9900	1.32
pO ₂	kPa	4.25	62.2	135	58	0.97	0.48	0.9947	0.68
	mmHg	31.9	466.5	135	58	0.97	3.63	0.9947	5.09
cCa ²⁺	mg/dL	2.04	9.12	142	66	0.91	0.38	0.9892	0.08
	mEq/L	1.02	4.56	142	66	0.91	0.19	0.9892	0.04
	mmol/L	0.51	2.28	142	66	0.91	0.10	0.9892	0.02

Parameter	Units	Range Low	Range High	Total n	Spiked n	Slope	Intercept	R ²	S _{y,x}
cCl ⁻	mEq/L	87	150	140	63	0.96	5.05	0.9516	1.80
	mmol/L	87	150	140	63	0.96	5.05	0.9516	1.80
cK ⁺	mEq/L	2.1	10.5	149	72	1.01	-0.10	0.9982	0.07
	mmol/L	2.1	10.5	149	72	1.01	-0.10	0.9982	0.07
cNa ⁺	mEq/L	121	174	147	70	1.06	-7.88	0.9873	0.91
	mmol/L	121	174	147	70	1.06	-7.88	0.9873	0.91
cGlu	mg/dL	9	702	147	70	1.01	-1.05	0.9963	5.54
	mmol/L	0.5	39.0	147	70	1.01	-0.06	0.9963	0.31
cLac	mg/dL	5	198	138	63	1.05	-0.83	0.9965	1.81
	mmol/L	0.5	22.0	138	63	1.05	-0.09	0.9965	0.20
ctBil*	mg/dL	0.8	35.9	56	9	0.998	0.54	0.993	0.744
	μmol/L	14	614	56	9	0.998	9.2	0.993	12.7
ctHb	g/dL	2.6	24.0	149	73	0.99	0.11	0.9919	0.30
sO ₂	%	13.9	100	145	69	1.00	-0.11	0.9975	0.79
FHHb	%	2.5	96.8	110	51	1.00	0.17	0.9978	0.83
FO ₂ Hb	%	7.5	98.5	140	66	0.99	0.49	0.9986	0.76
FCOHb	%	1.0	91.7	67	34	1.01	-0.47	0.9995	0.38
FMetHb	%	1.0	91.0	76	17	0.99	0.55	0.9989	0.54
FHbF	%	23	73	7	7	0.80	15.8	0.9584	4.63

*Bilirubin can only be measured on neonatal samples. This parameter is only available in the Neonate blood analysis 65 μL mode. Predicate device: Radiometer ABL835 FLEX analyzer.

ABL90 FLEX method comparison study results - capillary mode - site 3

Predicate device: Radiometer ABL835 analyzer.

A spiked sample is a sample that has been prepared by Radiometer. That means that the sample may or may not have been spiked with the specific parameter.

Parameter	Units	Range Low	Range High	Total n	Spiked n	Slope	Intercept	R ²	S _{y,x}
pH	N/A	6.898	7.797	169	81	0.98	0.16	0.9884	0.014
pCO ₂	kPa	2.06	12.9	166	78	0.92	0.25	0.9923	0.18
	mmHg	15.5	96.8	166	78	0.92	1.90	0.9923	1.34
pO ₂	kPa	4.12	57.2	159	72	1.01	-0.04	0.9986	0.32
	mmHg	30.9	429.0	159	72	1.01	-0.31	0.9986	2.39

Parameter	Units	Range Low	Range High	Total n	Spiked n	Slope	Intercept	R ²	S _{y.x}
cCa ²⁺	mg/dL	2.48	9.48	164	77	1.03	-0.16	0.9864	0.08
	mEq/L	1.24	4.74	164	77	1.03	-0.08	0.9864	0.04
	mmol/L	0.62	2.37	164	77	1.03	-0.04	0.9864	0.02
cCl ⁻	mEq/L	86	150	159	71	1.01	-1.76	0.9766	1.46
	mmol/L	86	150	159	71	1.01	-1.76	0.9766	1.46
cK ⁺	mEq/L	3.2	10.0	161	74	1.04	-0.10	0.9960	0.08
	mmol/L	3.2	10.0	161	74	1.04	-0.10	0.9960	0.08
cNa ⁺	mEq/L	117	176	165	78	1.08	-9.46	0.9885	0.89
	mmol/L	117	176	165	78	1.08	-9.46	0.9885	0.89
cGlu	mg/dL	9	684	165	78	0.97	-0.57	0.9969	5.13
	mmol/L	0.5	38.0	165	78	0.97	-0.03	0.9969	0.28
cLac	mg/dL	4	198	161	77	1.08	-2.96	0.9708	5.52
	mmol/L	0.4	22.0	161	77	1.08	-0.33	0.9708	0.61
ctBil*	mg/dL	1.1	35.7	77	8	0.977	1.12	0.985	0.866
	μmol/L	18	611	77	8	0.977	19.1	0.985	14.8
ctHb	g/dL	0.6	23.5	166	79	0.98	0.16	0.9973	0.20
sO ₂	%	12.1	99.9	160	73	0.98	1.33	0.9986	0.53
FHHb	%	2.4	98.5	119	57	0.99	0.20	0.9990	0.62
FO ₂ Hb	%	7.2	98.5	159	72	0.99	1.13	0.9988	0.65
FCOHb	%	1.0	91.7	53	37	1.00	-0.39	0.9995	0.45
FMetHb	%	1.0	90.2	101	30	0.99	0.54	0.9988	0.49
FHbF	%	35	83	8	8	1.04	-3.48	0.7901	7.96

*Bilirubin can only be measured on neonatal samples. This parameter is only available in the Neonate blood analysis 65 μL mode.

ABL90 FLEX method comparison study results - capillary mode - pooled data

POC comparison test.

A spiked sample is a sample that has been prepared by Radiometer. That means that the sample may or may not have been spiked with the specific parameter.

Parameter	Units	Range Low	Range High	Total n	Spiked n	Slope	Intercept	R ²	S _{y.x}
pH	N/A	6.824	7.797	465	222	0.99	0.09	0.9898	0.012
pCO ₂	kPa	2.1	12.9	465	221	0.95	0.14	0.9895	0.20
	mmHg	15.5	96.8	465	221	0.95	1.04	0.9895	1.51

Parameter	Units	Range Low	Range High	Total n	Spiked n	Slope	Intercept	R ²	S _{y,x}
pO ₂	kPa	4.1	62.2	441	199	0.99	0.17	0.9969	0.50
	mmHg	30.5	466.5	441	199	0.99	1.26	0.9969	3.75
cCa ²⁺	mg/dL	1.02	4.74	438	200	0.96	0.09	0.9795	0.05
	mEq/L	0.51	2.37	438	200	0.96	0.04	0.9795	0.03
	mmol/L	2.04	9.50	438	200	0.96	0.18	0.9795	0.11
cCl ⁻	mEq/L	86	150	446	203	1.00	-0.12	0.9663	1.71
	mmol/L	86	150	446	203	1.00	-0.12	0.9663	1.71
cK ⁺	mEq/L	2.1	10.5	458	217	1.01	-0.06	0.9952	0.09
	mmol/L	2.1	10.5	458	217	1.01	-0.06	0.9952	0.09
cNa ⁺	mEq/L	117	176	462	221	1.07	-8.49	0.9870	0.93
	mmol/L	117	176	462	221	1.07	-8.49	0.9870	0.93
cGlu	mg/dL	9	738	466	225	1.00	-1.43	0.9962	6.02
	mmol/L	0.5	41.0	466	225	1.00	-0.08	0.9962	0.33
cLac	mg/dL	4	198	447	215	1.05	-1.71	0.9805	4.28
	mmol/L	0.4	22.0	447	215	1.05	-0.19	0.9805	0.48
ctBil*	mg/dL	0.8	36.9	224	26	0.976	0.77	0.986	0.846
	μmol/L	14	631	224	26	0.976	13.2	0.986	14.5
ctHb	g/dL	0.6	24.0	468	228	0.99	0.20	0.9947	0.27
sO ₂	%	11.8	100.0	450	212	1.00	-0.55	0.9973	0.78
FHHb	%	2.4	98.5	331	162	1.00	0.43	0.9978	0.87
FO ₂ Hb	%	3.7	98.5	446	210	1.00	0.30	0.9984	0.81
FCOHb	%	1.0	92.2	198	110	1.01	-0.48	0.9994	0.43
FMetHb	%	1.0	91.0	246	63	1.00	0.29	0.9984	0.63
FHbF	%	21	83	25	22	0.95	5.62	0.8298	8.17

*Bilirubin can only be measured on neonatal samples. This parameter is only available in the Neonate blood analysis 65 μL mode.

Graphical presentation of POC comparison test results - capillary mode

Pooled data from the POC comparison test.

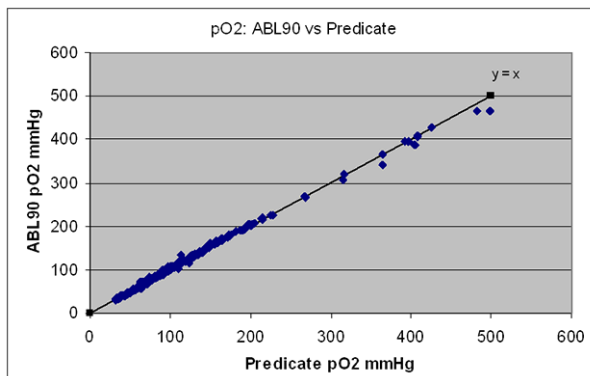
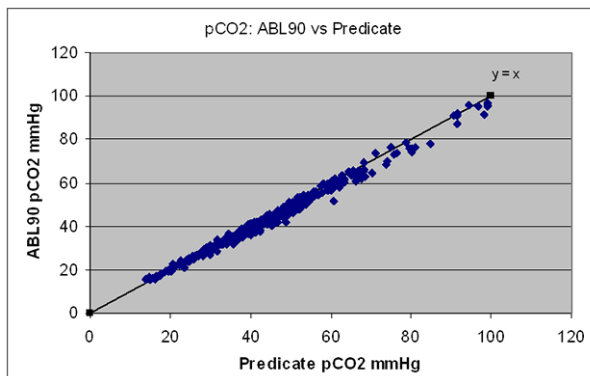
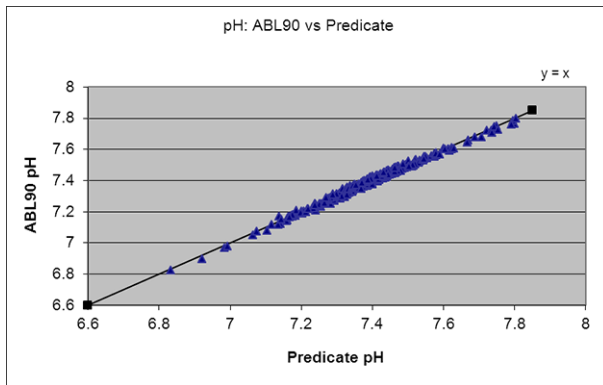

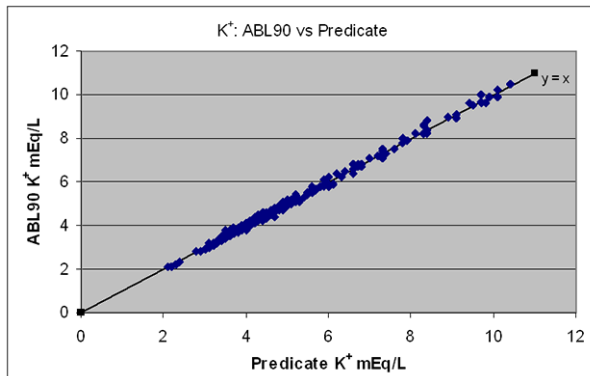
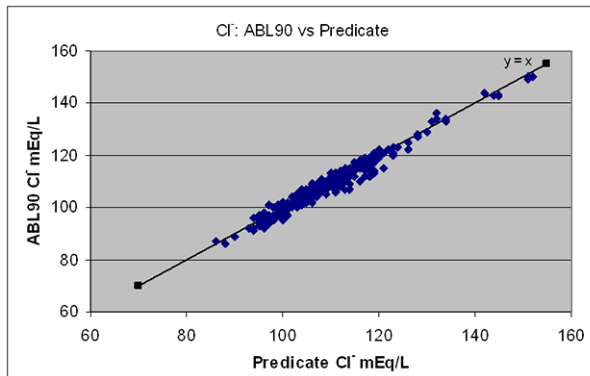
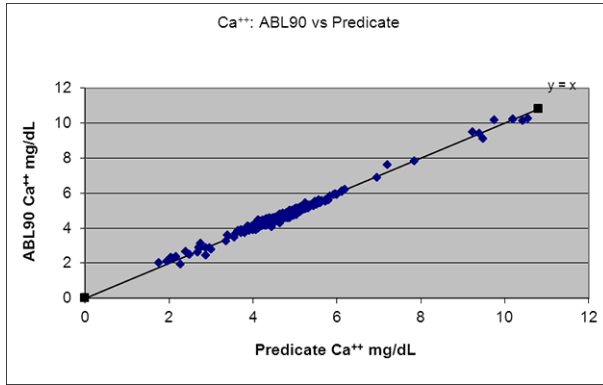

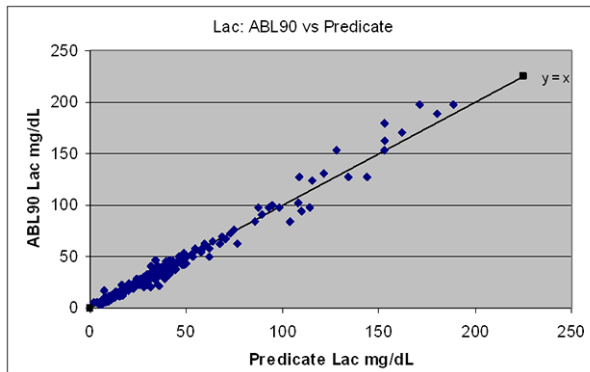
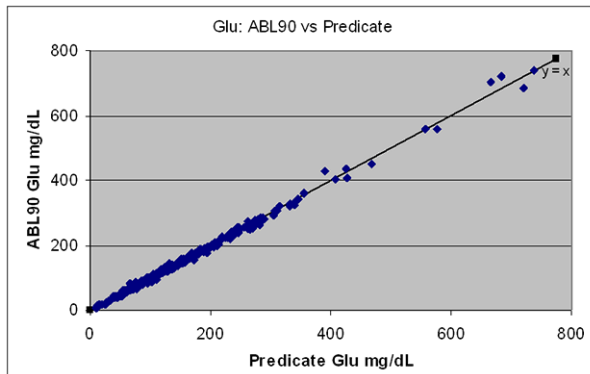
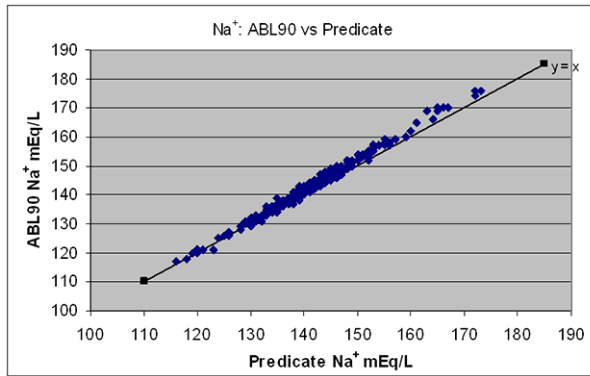

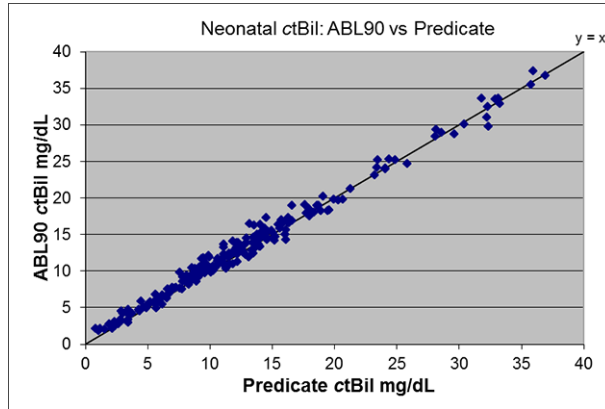

Bilirubin can only be measured on neonatal samples. This parameter is only available in the Neonate blood analysis 65 μ L mode.

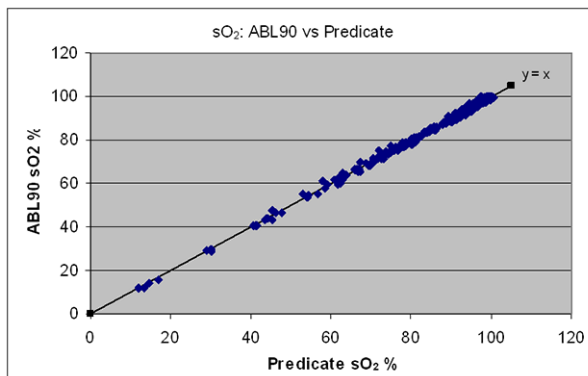
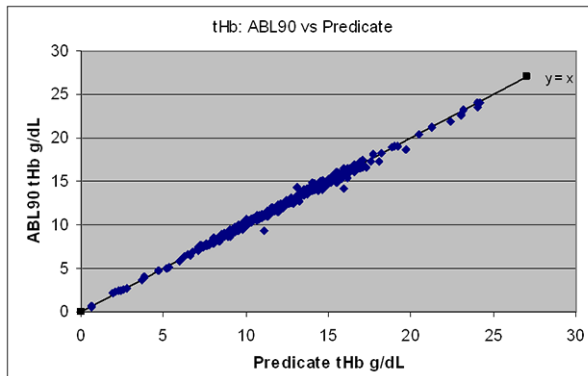

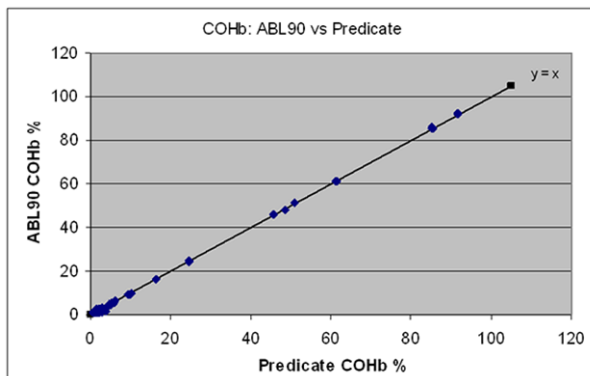
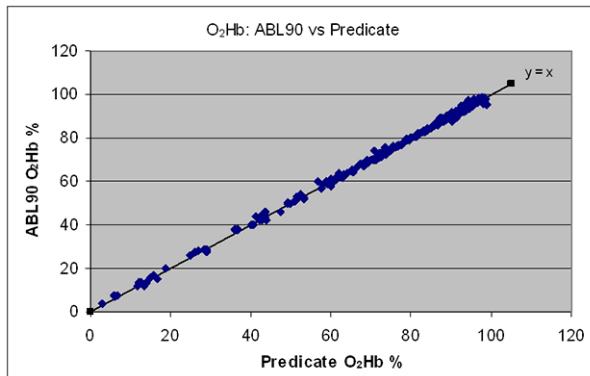
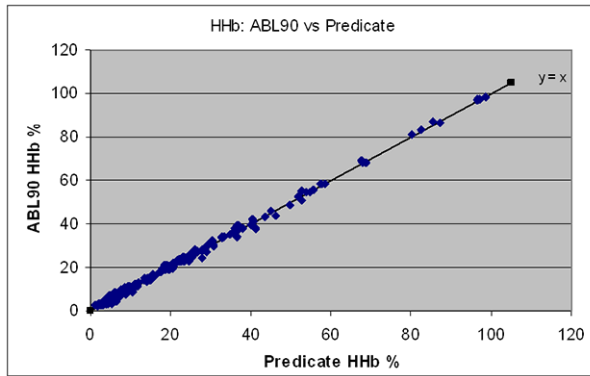

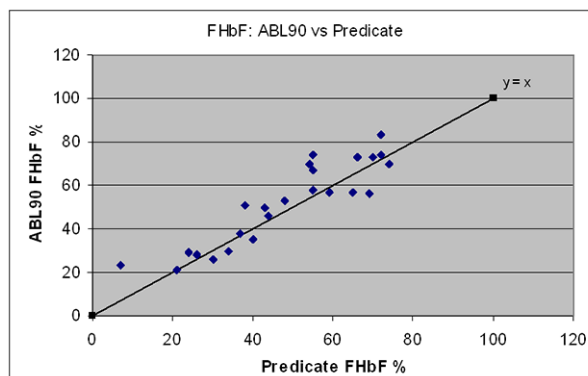
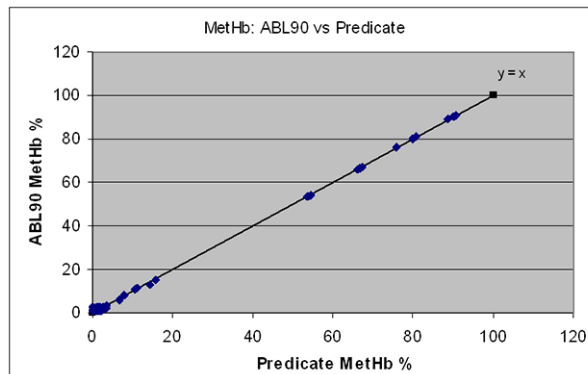

Traceability

Traceability to the primary standards at Radiometer

The Metrology Department at Radiometer is responsible for establishing metrological traceability for the measured parameters [25].

pH traceability

The primary pH standards are traceable to the definitive method for pH. The definitive method is based on a Hydrogen Electrode System. The primary pH standards are obtained from the Danish primary laboratory for Electrochemistry (DPLEC) at the Danish Institute of Fundamental Metrology (DFM). This primary laboratory is accredited by Danish Accreditation (DANAK accreditation no. 255). Certification is done in accordance with the method recommended by the International Union of Pure and Applied Chemistry (IUPAC). The Hydrogen Electrode System of DPLEC is validated by comparison with Standard Reference Materials (SRMs) produced by the National Institute of Standards and Technology (NIST). The primary standards are therefore also traceable to NIST.

The IUPAC-recommended method is described in [26].

The NIST SRMs used are: 186I/II-g, 185g, 187e, 191-I-d and 191_II-d.

Using the primary pH standards, the secondary pH standards are certified in the Metrology Section. These are normally of the same composition as the primary buffers, tapped into 2-mL glass ampoules and heat sterilized. The secondary buffers are stored

at 5 °C. Measurements of the secondary buffers are done using a glass electrode with a saturated calomel reference electrode and a liquid junction of saturated KCl. The liquid junction is a vertical, cylindrical and open liquid junction. Measurement of a secondary buffer is done using a primary buffer together with a certified secondary buffer as standards for making a 2-point calibration of the glass electrode arrangement.

$p\text{CO}_2$ and $p\text{O}_2$ traceability

The primary gases used are Standard Reference Materials (SRMs) produced by NIST. The NIST SRMs used are: 1674b and 2658a. The NIST SRM gases are used to validate primary gravimetric working gas standards, certified by Air Products. The primary gravimetric working gas standards are validated using a computer-controlled gas chromatography system, introducing the NIST SRM gases as samples and comparing the obtained results with the certified values.

The primary gravimetric working gas standards are used as standards in the gas chromatography system, so that the composition of secondary working gas standards can be determined.

By using the secondary working gas standards in a tonometer together with an aqueous buffer solution, a solution with a known $p\text{CO}_2$ and $p\text{O}_2$ is produced. This aqueous buffer solution is then used to determine the $p\text{CO}_2$ and $p\text{O}_2$ of secondary working standards. These secondary working standards are aqueous buffer solutions kept in 2-mL ampoules.

$c\text{K}^+$ and $c\text{Na}^+$ traceability

The primary working standards used are gravimetric standards produced from KCl and NaCl Suprapur, produced by Merck. These primary working standards are validated using Standard Reference Materials (SRMs) produced by NIST, so that traceability to NIST is achieved. The NIST SRMs used are: 919b (NaCl) and 999b (KCl). Validation of the primary working standards is done using a flame photometer together with the NIST SRMs.

The flame photometer method of validating the primary working standards is described in [27].

The primary working standards are used to determine the sodium and potassium concentrations of the secondary working standards. The concentrations of the secondary working standards are measured using a flame photometer.

$c\text{Ca}^{2+}$ traceability

The primary standards used are the so-called Ca^{2+} transfer standards, produced from NIST SRM 915b. The transfer standards are pH-stabilized to $\text{pH} = 7.4$, with 1 mmol/L HEPES and an ionic strength of 160.0 mmol per kg. Validation of the Ca^{2+} transfer standards is done using similar standards produced from NIST SRM 915b.

The transfer standards are used to determine the calcium concentrations of secondary standards. These measurements take place using ion-selective Ca electrodes on the ABL735 analyzer.

$c\text{Cl}^-$ traceability

The primary working standards are gravimetric standards, prepared from KCl Suprapur, produced by Merck. The primary working standards are validated by making comparative titrations using similar standards prepared from NIST SRM 999b (KCl). The titrations are done using an AgNO_3 solution as the titrant, and potentiometric titration equipment.

The standardized AgNO_3 solution is used as the titrant for the determination of the chloride concentration of the secondary standards, using the potentiometric titrator (Titrand 900 from Metrohm, Switzerland).

cGlu traceability

The primary working standards are prepared from NIST SRM 917c (D-glucose). These primary standards are used to determine the glucose concentration of secondary standards. The measurements take place using the glucose reference method, which is the hexokinase/glucose-6-phosphate dehydrogenase method recommended by CLSI. This method is described in [7].

cLac traceability

No certified standard reference material for lactate is available at present. The primary working standards are therefore prepared from a pure commercially available material, namely the Lithium salt of L^+ Lactic Acid (Cat. No. L-2250) supplied by the Sigma Chemical Company.

These primary standards are used to determine the lactate concentration of secondary standards.

The measurements take place using a spectrophotometric method. The method is based on a reaction of lactate, catalyzed by L-Lactate Dehydrogenase (LDH). The reaction produces dihydronicotinamide (NADH), which is measured at 339 nm. The method is described in [8].

ctHb traceability

The primary standard used is an oxygenated blood sample. The ctHb value of this sample is determined by the use of the HiCN reference method. This method is described in [28]. The HiCN reference method is a spectrophotometric method. The spectrophotometer used is calibrated using a NIST SRM 930D filter. This method is further validated using the certified reference material Hemoglobin-cyanide standard (BCR - 522, Institute for Reference Materials and Measurements, Belgium).

The primary standard is used to calibrate the ABL735 reference instruments.

Saturation – $\text{sO}_2 = 100\%$ – traceability

The primary working standard used is a blood sample, with the ctHb value adjusted to between 13 and 15 g/dL. The blood sample is tonometered with 5.6 % CO_2 – 94.4 % O_2 , traceable to NIST SRM gases.

The primary standard is used to calibrate the ABL735 reference instruments.

Saturation – $\text{sO}_2 = 0\%$ – traceability

The primary working standard used is a blood sample. The blood sample is deoxygenated by the use of Argon and treated with a dithionite solution.

The primary working standard is used to calibrate the ABL735 reference instruments.

FCOHb – normal value - traceability

The primary standards used are CO with atmospheric air mixtures, produced in a container of known volume. The CO used for making these gas mixtures has a certified purity of 99.997 %. Validation of the mixing method is done by comparison with NIST SRM 1678 (50 ppm CO in N_2).

The produced mixtures are used as calibration standards in connection with a gas chromatography method. The gas sample, injected into the gas chromatograph, is the gas phase of a blood sample from a closed test tube, in which the blood sample has been treated so that all the bound CO is released from the hemoglobin. The analyzed result is measured in % CO, and from this the *FHbCO* is calculated. The method is described in [29].

The measured blood sample is used as secondary standard and is used to calibrate the ABL735 reference instruments.

***F*COHb – 100 % - traceability**

The primary working standard used is a blood sample. The blood sample is tonometered with 100 % CO, with a certified purity of 99.997 % CO. The primary working standard is used to calibrate the ABL735 reference instruments.

***F*MetHb traceability**

The primary working standard is a blood sample. The *F*MetHb is determined using the KCN addition method according to Evelyn and Malloy [10]. This method is a spectrophotometric method, where the absorbance measurements are done at 630 nm (local peak for MetHb) on two sets of solutions, prepared from the blood sample. The first set allows determination of the relative MetHb content, whereas ctHb is determined from the second set. From these measurements, the *F*MetHb of the blood sample can be calculated.

***F*HbF traceability**

The primary working standard is a blood sample. The *F*HbF of this sample is determined using the Cation Exchange HPLC reference method. The method is described in [11]. The method is performed by the Hematology Laboratory at Herlev Hospital, Denmark.

Hct traceability

Reference method: Radiometer uses a reference method based on the packed-cell-volume procedure described by the Clinical and Laboratory Standards Institute [30]. The packed-cell volume is the measure of the ratio of the volume occupied by the red cells to the volume of blood in a sample of capillary or venous blood. The ratio is measured after appropriate centrifugation.

Radiometer measurements: The Hct measurement is based on conductivity measured in a sample and then corrected for the presence of sodium ions. A Sigma 201 Micro hematocrit centrifuge with RCF of 12620*g, which meets most of the CLSI requirements, has been used for the test together with 75 mm Microhematocrit capillary tubes with an inner diameter between 1.1 and 1.2 mm. The centrifugation time has been 5 minutes.

The conductivity and sodium concentration have been measured on approximately 1000 blood samples with a sodium concentration varying from 80 mmol/L to 180 mmol/L. Hct measurements have then been correlated to the Hct measured by the reference method.

ctBil* traceability

The primary working standard is a blood sample. The total neonatal bilirubin* is determined on a serum sample prepared from this. The determination is performed using a Hitachi 717 wet-chemistry analyzer, which uses the Boehringer Mannheim reagency kit, DPD method, given in [18]. The reference instrument is calibrated using four levels of NIST SRM916a unconjugated bilirubin standard material.

* Bilirubin can only be measured on neonatal samples. This parameter is only available in the Neonate blood analysis 65 µL mode.

References

1. CLSI Evaluation of Precision Performance of Clinical Chemistry Devices; Approved Guidelines, EP5-A, Vol. 19, No. 2.
2. VIM93: ISO, International Vocabulary of Basic and General Terms in Metrology, Geneva: International Organization for Standardization; 1993.
3. Kristensen HB, Salomon A, Kokholm G. International pH scales and certification of pH.
4. Definition of pH scales, standard reference values, measurement of pH and related terminology (Recommendations 1994). *Pure and Appl Chem* 1985; 57, 3: 531-42.
5. Burnett RW, Covington AK, Maas AHJ, Müller-Plathe O et al. *J Clin Chem Clin Biochem* 1989; 27: 403-08.
6. IFCC reference methods and materials for measurement pH, gases and electrolytes in blood. *Scand J Clin Lab Invest* 1993; 53, Suppl 214: 84-94.
7. Glucose. CLSI/NCCLS Publication RS1-A. Clinical and Laboratory Standards Institute, 940 West Valley Road, Suite 1400, Wayne, PA 19087, 1989.
8. Bergmeyer. *Methods of enzymatic analysis*. 3rd ed., Verlag Chemie Deerfield Beach 1984; 6: 582-88.
9. Reference and selected procedures for the quantitative determination of hemoglobin in blood. Approved Standard (3rd edition), CLSI/NCCLS Publication H15-2A. Clinical and Laboratory Standards Institute, 940 West Valley Road, Suite 1400, Wayne, PA 19087, 2000.
10. Evelyn K, Malloy H. Microdetermination of oxyhemoglobin, methemoglobin and sulfhemoglobin in a single sample of blood. *Biological Chem* 1938; 126: 655-62.
11. Tan GB, Aw TC, Dunstan RA & Lee SH, Evaluation of high performance liquid chromatography for routine estimation of haemoglobins A2 and F. *Journal of Clinical Pathology* 46: 852-856.
12. CLSI Method Comparison and Bias Estimation Using Patient Samples; Approved Guideline - Second Edition, EP9-A2, Vol. 22, No. 17.
13. Fraser CG. The application of theoretical goals based on biological variation data in proficiency testing. *Arch Pathol Lab Med* 1988; 112: 402-15.
14. Ehrmeyer SS, Laessig RH, Leinweber JE, Oryall JJ. 1990 Medicare/CLIA final rules for proficiency testing: minimum intralaboratory performance characteristics (CV and bias) needed to pass. *Clin Chem* 1990; 36, 10: 1736-40.
15. Fraser CG, Petersen PH, Ricos C, Haeckel R. Proposed quality specifications for the imprecision and inaccuracy of analytical systems for clinical chemistry. *Eur J Clin Chem Clin Biochem* 1992; 30: 311-17.
16. Westgard JO, Seehafer JJ, Barry PL. Allowable imprecision for laboratory test based on clinical and analytical test outcome criteria. *Clin Chem* 1994; 40, 10: 1909-14.
17. Vanderline RE, Goodwine J, Koch D, Scheer D, Steindel S, Cembrowski G. Guidelines for providing quality stat laboratory services. 1987 Laboratory Quality Assurance Committee.
18. Wahlefeld AW, Herz G, Bernt E. Modification of the Malloy-Evelyn method for a simple, reliable determination of total bilirubin in serum. *Scand J Clin Lab Invest* 1972;29 Supplement 126: Abstract 11:12.
19. Burtis CA, Ashwood ER, Bruns DE. *Tietz textbook of clinical chemistry and molecular diagnostics*. 5th ed. St. Louis: Saunders Elsevier, 2012.
20. Siggaard-Andersen O, Thode J, Wandrup JH. The concentration of free calcium ions in the blood plasma ionized calcium. In: Siggaard-Andersen O, ed. *Proceedings of the IFCC expert panel on pH and blood gases held at Herlev Hospital 1980*. Copenhagen: Radiometer Medical A/S, 1981: 163-90. Available as AS79.
21. NCCLS Interference testing in Clinical Chemistry Approved Guideline - Second Edition, EP7-A2, 2005. Chapter 5.4 Potential Interfering Substances.
22. CLSI approved guideline for interference testing in clinical chemistry, EP7-A, Vol. 22, No. 27.

- 23.** Giegy Scientific Tables, Physical Chemistry, Composition of Blood, Hematology, Somametric Data, Ciba-GEIGY, 1984; 3, 207.
- 24.** CLSI Protocols for Determination of Limits of Detection and Limits of Quantitation; Approved Guidelines, EP17-A, Vol. 24, No. 34.
- 25.** Kristensen H.B. Traceability to the primary reference standards at Radiometer. Copenhagen: Radiometer Medical ApS, 2004. Code 918-541.
- 26.** Measurement of pH. Definition, standards, and procedures. (IUPAC Recommendations 2002). Pure and Appl Chem 2002; 74, 11: 2169-2200.
- 27.** Standardization of sodium and potassium ion selective electrode systems to the flame photometric method. NCCLS (CLSI) Publication C29-A2. Villenova, Pa.: NCCLS, 2000.
- 28.** Reference methods for the quantitative determination of hemoglobin in blood samples. NCCLS (CLSI) Publication H15-A3. Villenova, Pa.: NCCLS, 2000.
- 29.** Collison HA, Rodkey FL, O'Neal JD. Determination of carbon monoxide in blood by gas chromatography. Clin Chem 1968; 14, 2: 162-71.
- 30.** Procedure for determining packed cell volume by microhematocrit method. 2nd ed. Approved standard. NCCLS (CLSI) Publication H7-A3. Villenova, Pa.: NCCLS, 2000.

Derived and input parameters 11

Parameter types

Some parameters are measured by the analyzer, others are calculated from equations that use measured / keyed-in / default values of other parameters.

Parameter type	Description
Measured parameters	Parameters that are measured by the analyzer
Input parameters	Parameters that are keyed-in (entered) by an operator
Derived parameters	Parameters that are calculated from measured, input and default values

Parameter symbols

The symbols for the parameters are based on the principles described by Wandrup [1]. Each symbol has three parts:

1	A character in italics that is an abbreviation of the property (quantity)	Examples: <ul style="list-style-type: none"> • <i>p</i> for pressure • <i>c</i> for concentration • <i>F</i> for fraction • <i>V</i> for volume
2	An abbreviation of the parameter	Examples: <ul style="list-style-type: none"> • O₂ for oxygen • CO₂ for carbon dioxide • COHb for carboxyhemoglobin
3	A character that is an abbreviation of the system	<ul style="list-style-type: none"> • B for blood • P for plasma • a for arterial blood • \bar{v} for mixed venous blood • A for alveolar air • T for patient temperature

Example:

$pO_2(a)$, where *p* = pressure, O₂ = oxygen, (a) = arterial blood.

Input parameters – definitions and acceptable values

Input parameters are parameter values that can be entered by operators, or transferred to the analyzer from an interfaced database. Only values that fall within a given range are accepted.

Parameter symbol	Definition	Unit	Input range
T	Patient temperature	°C	15.0-45.0
		°F	59.0-113.0
N/A	Temperature Note: This is a data field in the Quality control identification screen. To get the correct QC results, it is necessary that the ampoule temperature is entered in this field.	°C	18.0-32.0
		°F	64.4-89.6
$FO_2(I)$	Fraction of oxygen in dry inspired air	%	0-100
		Fraction	0.000-1.000
ctHb	Concentration of total hemoglobin in blood. Note: Is used if the analyzer version does not include the oximetry measuring system.	g/dL	0.0-33.0
		g/L	0-330
		mmol/L	0.0-20.5
RQ	Respiratory quotient, ratio between the CO ₂ production and the O ₂ consumption	Fraction	0.00-2.00
$pO_2(\bar{v})$	Oxygen tension of mixed venous blood	mmHg; Torr	0.0-750.0
		kPa	0.00-100
$sO_2(\bar{v})$	Oxygen saturation of mixed venous blood	%	0.0-100.0
		Fraction	0.000-1.000
\dot{Q}_t	Cardiac output; volume of blood delivered from the left ventricle into the aorta per unit of time. Note: Also termed CO or C.O.	L/min	0.0-100.0
$\dot{V}O_2$	Oxygen consumption; total amount of oxygen used by the whole organism per unit of time	mL/min	0-21000
		mmol/min	0.0-937.1
VCO	Volume of carbon monoxide added to the patient for measurement and calculation of V(B) [5]	mL	0.0-1000.0
$FCO_{Hb}(1)$	The fraction of COHb measured before a CO injection	%	0.0-100.0
		Fraction	0.000-1.000
$FCO_{Hb}(2)$	The fraction of COHb measured after a CO injection	%	0.0-100.0
		Fraction	0.000-1.000

Derived parameters

Derived parameters are calculated from equations that can include the measured and/or input (keyed-in) values of other parameters. The accuracy of derived parameters depends on the accuracy and availability of these values.

There are two types of derived parameter:

Derived parameter type	Explanation	Symbols on derived parameter results
Calculated	Necessary measured and keyed-in values are available	Subscript c. For example: x.xxx _c mmol/L
Estimated	Necessary keyed-in and/or measured values are not available. Default values are used. Note: Default values are only used for missing measured values, when they are clinically appropriate. Note: Estimated oxygen status parameter values may deviate significantly from the <i>true</i> values.	Subscript e. For example: x.xxx _e mmol/L

Note: When a necessary measured value is outside the range of indication*, no default value is used. No result is given for the derived parameter.

* The Range of indication is the range the analyzer is capable of measuring and includes values outside the Reportable range. The performance of the analyzer outside the Reportable range specified in the Specifications chapter has not been validated.

Only results within the Reportable range should be reported.

Default values of parameters

Parameter values that are necessary in order to calculate derived parameters are given a default value when no other value is available.

Parameter symbol / name	Parameter type	Description	Default value	When is the default used?
T	Input	Patient temperature	37.0 °C (98.6 °F)	When no value is entered
Temperature	Input	Ambient temperature Note: This is a data field in the Quality control identification screen. To get the correct QC results, it is necessary that the room temperature is entered in this field.	25.0 °C (77 °F)	When no value is entered
FO ₂ (I)	Input	Fraction/(%) of oxygen in dry inspired air	0.21 (21.0 %)	When no value is entered
RQ	Input	Respiratory quotient, ratio between the CO ₂ production and the O ₂ consumption	0.86	When no value is entered
ctHb	Measured	Concentration of total hemoglobin in blood	9.3087 mmol/L, (15.00 g/dL or 150 g/L)	When the parameter cannot be measured

Parameter symbol /name	Parameter type	Description	Default value	When is the default used?
<i>FCO</i> Hb	Measured	Fraction/(%) of carboxyhemoglobin in total hemoglobin in blood	0.004/ (0.4 %)	When the parameter cannot be measured
<i>FMet</i> Hb	Measured	Fraction/(%) of methemoglobin in total hemoglobin in blood	0.004/ (0.4 %)	When the parameter cannot be measured
<i>p</i> 50(st)	Derived	Partial pressure (or tension) of oxygen at half saturation (50%) in blood under standard conditions: <ul style="list-style-type: none"> • $T = 37\text{ °C}$ • $\text{pH} = 7.40$ • $p\text{CO}_2 = 5.33\text{ kPa}$ • <i>FCO</i>Hb, <i>FMet</i>Hb, <i>FHbF</i> are set to zero 	3.578 kPa (26.84 mmHg)	When the parameter cannot be derived

Definitions of derived parameters

Acid-base derived parameters – definitions

Symbol	Definition
$\text{pH}(T)$	pH of blood at patient temperature
$\text{cH}^+(T)$	Concentration of hydrogen ions in blood at patient temperature
$p\text{CO}_2(T)$	Partial pressure (or tension) of carbon dioxide at patient temperature
$\text{cHCO}_3^-(P)$	Concentration of hydrogen carbonate in plasma (also termed actual bicarbonate)
<i>cBase</i> (B) or ABE	Actual Base Excess, the concentration of titrable base when the blood is titrated with a strong base or acid to a plasma pH of 7.40, at $p\text{CO}_2$ of 5.33 kPa (40 mmHg) and 37 °C, at the actual oxygen saturation [2,3,4]. Positive values (base excess) indicate a relative deficit of noncarbonic acids; negative values (base deficit) indicate a relative excess of noncarbonic acids.
<i>cBase</i> (B,ox)	<i>cBase</i> (B) of fully oxygenated blood
<i>cBase</i> (Ecf) or SBE	Standard Base Excess, an <i>in vivo</i> expression of base excess [3,4,5]. It refers to a model of the extracellular fluid (one part of blood is diluted by two parts of its own plasma) and is calculated using a standard value for the hemoglobin concentration of the total extracellular fluid.
<i>cBase</i> (Ecf,ox)	<i>cBase</i> (Ecf) of fully oxygenated blood
$\text{cHCO}_3^-(P,\text{st})$	Standard Bicarbonate, the concentration of hydrogen carbonate in the plasma from blood that is equilibrated with a gas mixture with $p\text{CO}_2 = 5.33\text{ kPa}$ (40 mmHg) and $p\text{O}_2 \geq 13.33\text{ kPa}$ (100 mmHg) at 37 °C [2,3]
$\text{ctCO}_2(P)$	Concentration of total carbon dioxide, (free CO_2 + bound CO_2) in plasma
$\text{ctCO}_2(B)$	Concentration of total carbon dioxide in blood (also termed CO_2 content). Calculated based on the total CO_2 concentrations in the two phases: plasma and erythrocyte fluid [3].

Symbol	Definition
pH(st)	Standard pH (or eucapnic pH), defined as the pH of plasma of blood equilibrated to $p\text{CO}_2 = 5.33 \text{ kPa}$ (40 mmHg). By ensuring the normal value of $p\text{CO}_2$, the respiratory influence from pH is removed, and pH(P,st) therefore reflects the metabolic status of the blood plasma.
$\text{VCO}_2/\text{V}(\text{dry air})$	The volume fraction of carbon dioxide in dry air

Oximetry derived parameters – definitions

The oximetry parameters are only derived if the analyzer cannot measure them.

Parameter	Definition
FHHb	Fraction of deoxyhemoglobin in total hemoglobin in blood. Deoxyhemoglobin is the part of total hemoglobin which can bind oxygen, and thus forms oxyhemoglobin. It is also termed reduced hemoglobin, RHb.
FO_2Hb	Fraction of oxyhemoglobin in total hemoglobin in blood
$s\text{O}_2$	Oxygen saturation, the ratio between the concentrations of oxyhemoglobin and the hemoglobin minus the dyshemoglobins
Hct	Hematocrit, the ratio between the volume of erythrocytes and the volume of blood

Oxygen derived parameters - definitions

Symbol	Definition
$p\text{O}_2(T)$	Partial pressure (or tension) of oxygen at patient temperature
$p\text{O}_2(A)$	Partial pressure (or tension) of oxygen in alveolar air
$p\text{O}_2(A,T)$	Partial pressure (or tension) of oxygen in alveolar air at patient temperature
$p\text{O}_2(a)/\text{FO}_2(I)$	Oxygen tension ratio of arterial blood and the fraction of oxygen in dry inspired air
$p\text{O}_2(a,T)/\text{FO}_2(I)$	Oxygen tension ratio of arterial blood at patient temperature and the fraction of oxygen in dry inspired air
$p50$	Partial pressure (or tension) of oxygen at half saturation (50%) in blood. High and low values indicate decreased and increased affinity of oxygen to hemoglobin, respectively.
$p50(T)$	Partial pressure (or tension) of oxygen at half saturation (50%) in blood at patient temperature
$p50(\text{st})$	Partial pressure (or tension) of oxygen at half saturation (50%) in blood at standard conditions: $T = 37 \text{ }^\circ\text{C}$ $\text{pH} = 7.40$ $p\text{CO}_2 = 5.33 \text{ kPa}$ FCO_2Hb , FMetHb , FHbF are set to zero. $p50(\text{st})$ may, however, vary due to variations in 2,3-DPG concentration or to the presence of abnormal hemoglobins.

Symbol	Definition
$pO_2(A-a)$	Difference in the partial pressure (or tension) of oxygen in alveolar air and arterial blood. Indicates the efficacy of the oxygenation process in the lungs.
$pO_2(A-a,T)$	Difference in the partial pressure (or tension) of oxygen in alveolar air and arterial blood at patient temperature
$pO_2(a/A)$	Ratio of the partial pressure (or tension) of oxygen in arterial blood and alveolar air. Indicates the efficacy of the oxygenation process in the lungs.
$pO_2(a/A,T)$	Ratio of the partial pressure (or tension) of oxygen in arterial blood and alveolar air at patient temperature
$pO_2(x)$ or p_x	Oxygen extraction tension of arterial blood. Reflects the integrated effects of changes in the arterial $pO_2(a)$, ctO_2 and $p50$ on the ability of arterial blood to release O_2 to the tissues [6].
$pO_2(x,T)$ or $p_x(T)$	Oxygen extraction tension of arterial blood at patient temperature
$ctO_2(B)$	Total oxygen concentration of blood. Also termed O_2 content.
$ctO_2(a-\bar{v})$	Oxygen concentration difference between arterial and mixed venous blood
BO_2	Hemoglobin oxygen capacity; the maximum concentration of oxygen bound to hemoglobin in blood saturated, so that all deoxyhemoglobin is converted to oxyhemoglobin.
$ctO_2(x)$	Extractable oxygen concentration of arterial blood. Defined as the amount of O_2 that can be extracted per liter of arterial blood at an oxygen tension of 5.0 kPa (38 mmHg), which maintains a constant pH and pCO_2 [6].
$\dot{D}O_2$	Oxygen delivery; the total amount of oxygen delivered to the whole organism per unit of time
\dot{Q}_t	Cardiac output; volume of blood delivered from the left ventricle into the aorta per unit of time. Also termed CO or C.O.
$\dot{V}O_2$	Oxygen consumption; total amount of oxygen utilized by the whole organism per unit of time
$FO_2(I)$	Fraction of oxygen in dry inspired air
$FShunt$	Relative physiological shunt or concentration-based shunt [3,6,7]. <ul style="list-style-type: none"> Calculated from the pulmonary shunt equation: $\frac{\dot{Q}_s}{\dot{Q}_t} = \frac{1}{1 + \frac{ctO_2(a-\bar{v})}{ctO_2(A) - ctO_2(a)}}$ if both arterial and mixed venous blood samples are used. May be estimated from one arterial sample by assuming a constant difference in the concentrations of total oxygen in arterial and mixed venous blood: $ctO_2(a-\bar{v}) = 2.3$ mmol/L (5.15 mL/dL)
$FShunt(T)$	$FShunt$ at patient temperature

Symbol	Definition
RI	Respiratory Index; ratio between the oxygen tension difference of alveolar air and arterial blood and the oxygen tension of arterial blood.
RI(T)	Respiratory Index; ratio between the oxygen tension difference of alveolar air and arterial blood and the oxygen tension of arterial blood at patient temperature.
$VO_2/V(\text{dry air})$	Volume fraction of oxygen in dry air
Q_x	Cardiac oxygen compensation factor of arterial blood defined as the factor by which the cardiac output should increase to allow release of 2.3 mmol/L (5.1 mL/dL) oxygen at a mixed venous pO_2 of 5.0 kPa (38 mmHg) [3,6]
V(B)	Volume of blood, calculated when FCOHb and V(CO) values are keyed in [3]

Electrolyte derived parameters – definitions

Parameter	Definition
Anion Gap, K^+	Difference between the concentration of the cations (sodium and potassium), and the measured anions (chloride and bicarbonate)
Anion Gap	Difference between the concentration of the cation (sodium), and the measured anions (chloride and bicarbonate)
$cCa^{2+}(7.4)$	Concentration of calcium cations at pH = 7.40
$mOsm$	$[1/1000] \times$ Number of moles of ions that contribute to the osmotic pressure of a solution

Data necessary to derive electrolyte parameters

The table shows the measured parameters that are necessary to calculate the derived electrolyte parameters.

Parameter	Unit	Necessary measured parameters
Anion Gap, K^+	mmol/L, meq/L	cK^+ , cNa^+ , cCl^-
Anion Gap	mmol/L, meq/L	cNa^+ , cCl^-
$cCa^{2+}(7.4)$	mmol/L, meq/L, mg/dL	pH, cCa^{2+} Note: pH must be between 7.2-7.6 to calculate this parameter.
$mOsm$	mmol/kg	cNa^+ , $cGlu$

Calculation of derived parameters

Sample type

Unless otherwise stated, a derived parameter will be calculated or estimated irrespective of the sample type selected on the **Patient identification** screen:

- Arterial
- Capillary
- Venous
- Mixed venous
- Cord blood arterial
- Cord blood venous
- Fetal scalp
- Not specified

Some parameters, however, are defined for arterial or capillary samples only; they will be calculated only for sample types entered as "Arterial" or "Capillary".

The symbol for system (blood (B) or plasma (P)) is not stated in the equations unless it is important for the calculation.

Units and symbols used in equations

All definitions and equations are based on SI units. If "T" for patient temperature is not stated, the calculation is based on a temperature of 37.0 °C.

The following SI units are used:

Description	Unit
Concentration	mmol/L
Temperature	°C
Pressure	kPa
Fractions	- (not %)

The following symbols are used in the equations:

$$\log(x) = \log_{10}(x)$$

$$\ln(x) = \log_e(x)$$

Equations

Equations for acid-base parameters

pH(T) - equation 1

Ref. [13]:

$$\text{pH}(T) = \text{pH}(37) - [0.0147 + 0.0065 \times (\text{pH}(37) - 7.40)][T - 37]$$

Note: The equation is different from that of previous Radiometer analyzers. The constant 0.0146 is now changed to 0.0147, to be in accordance with NCCLS (CLSI)-approved guidelines [8].

The change corresponds to -0.1 mpH/°C.

cH⁺(T) - equation 2

$$c\text{H}^+(T) = 10^{(9-\text{pH}(T))}$$

$p\text{CO}_2(T)$ - equation 3

Ref. [4]:

$$p\text{CO}_2(T) = p\text{CO}_2(37) \times 10^{[0.019 \times (T-37)]}$$

Note: The equation is different from that of previous Radiometer analyzers. The constant 0.021 is now changed to 0.019, to be in accordance with NCCLS (CLSI)-approved guidelines [2].

The change corresponds to 2 %/5 °C.

 $\text{cHCO}_3^-(P)$ - equation 4

Ref. [19]:

$$\text{cHCO}_3^-(P) = 0.23 \times p\text{CO}_2 \times 10^{[\text{pH}-\text{pK}_p]}$$

where $\text{pK}_p = 6.095$

$\text{cHCO}_3^-(P)$ includes ions of hydrogen carbonate, carbonate and carbamate in the plasma.

Note: The equation is different from that of previous Radiometer analyzers. The pK_p is now constant, to be in accordance with NCCLS (CLSI)-approved guidelines [4].

The change corresponds to 5 % in the pH range 7-7.8.

 $\text{cBase}(B)$ - equation 5

Ref. [4]:

$$\text{cBase}(B) = (1 - 0.014\text{ctHb})(\text{cHCO}_3^-(P) - 24.8 + (1.43 \text{ctHb} + 7.7)(\text{pH} - 7.4))$$

Note: The equation is different from that of previous Radiometer analyzers. The calculation is done in accordance with NCCLS (CLSI)-approved guidelines [5].

However, the previous method [9] is considered a better method. The change corresponds to less than 0.6 mmol/L in the reference ranges for pH, $p\text{CO}_2$ and ctHb. The previous range checks are retained. Outside the ± 50 mmol/L range, no values are displayed. Outside the range ± 30 mmol/L, values are tagged with ?.

 $\text{cBase}(B,ox)$ - equation 6

Ref. [2]:

$$\text{cBase}(B,ox) = \text{cBase}(B) - 0.3062 \times \text{ctHb} \times (1 - s\text{O}_2)$$

If ctHb is not measured or keyed in, the default value will be used.

If $s\text{O}_2$ is not measured, it will be calculated from equation 39.

 $\text{cBase}(Ecf)$ - equation 7

Ref. [5]:

$$\text{cBase}(Ecf) = \text{cHCO}_3^-(P) - 24.8 + 16.2 (\text{pH} - 7.4)$$

See the note in equation 5.

 $\text{cBase}(Ecf,ox)$ - equation 8

$$\text{cBase}(Ecf,ox) = \text{cBase}(Ecf) - 0.3062 \times 3 \times (1 - s\text{O}_2)$$

cHCO₃⁻(P,st) - equation 9

Refs. [2,9]:

$$c\text{HCO}_3^-(\text{P,st}) = 24.47 + 0.919 \times Z + Z \times a' \times (Z - 8)$$

Where

Equation	Description
9.1	$a' = 4.04 \times 10^{-3} + 4.25 \times 10^{-4} \times \text{ctHb}$
9.2	$Z = \text{cBase(B)} - 0.3062 \times \text{ctHb} \times (1 - s\text{O}_2)$

ctCO₂(P) - equation 10

Refs. [4,5]:

$$\text{ctCO}_2(\text{P}) = 0.23 \times p\text{CO}_2 + c\text{HCO}_3^-(\text{P})$$

ctCO₂(B) - equation 11

Ref. [3]:

$$\text{ctCO}_2(\text{B}) = 9.286 \times 10^{-3} \times p\text{CO}_2 \times \text{ctHb} \times \left[1 + 10^{(\text{pH}_{\text{Ery}} - \text{pK}_{\text{Ery}})} \right] + \text{ctCO}_2(\text{P}) \times \left(1 - \frac{\text{ctHb}}{21.0} \right)$$

where

Equation	Description
11.1	$\text{pH}_{\text{Ery}} = 7.19 + 0.77 \times (\text{pH} - 7.40) + 0.035 \times (1 - s\text{O}_2)$
11.2	$\text{pK}_{\text{Ery}} = 6.095 - \log[1 + 10^{(\text{pH}_{\text{Ery}} - 7.84 - 0.06 \times s\text{O}_2)}]$

pH(st) - equation 12

Ref. [9]:

pH (st): see equations 5.3-5.5.

Equation	Description
5.3	$\text{pH}(\text{st}) = \text{pH} + \log\left(\frac{5.33}{p\text{CO}_2}\right) \times \left(\frac{\text{pH}(\text{Hb}) - \text{pH}}{\log p\text{CO}_2(\text{Hb}) - \log(7.5006 p\text{CO}_2)}\right)$
5.4	$\text{pH}(\text{Hb}) = 4.06 \times 10^{-2} \text{ctHb} + 5.98 - 1.92 \times 10^{(-0.16169 \text{ctHb})}$
5.5	$\log p\text{CO}_2(\text{Hb}) = -1.7674 \times 10^{-2} \text{ctHb} + 3.4046 + 2.12 \times 10^{(-0.15158 \text{ctHb})}$

Equations for electrolyte parameters**Anion Gap, K⁺ equation 43**

$$\text{Anion Gap, K}^+ = c\text{Na}^+ + c\text{K}^+ - c\text{Cl}^- - c\text{HCO}_3^-$$

Anion Gap - equation 44

$$\text{Anion Gap} = c\text{Na}^+ - c\text{Cl}^- - c\text{HCO}_3^-$$

cCa²⁺(7.4) - equation 45

Ref. [10]:

$$c\text{Ca}^{2+}(7.4) = c\text{Ca}^{2+} \times 10^{-0.24(7.4-\text{pH})}$$

Due to biological variations, this equation can only be used for a pH value in the range 7.2-7.6.

Note: The equation is different from that of previous Radiometer analyzers. The previous equation was an approximation of the current equation.

The change corresponds to 1 % in the pH range 7.2-7.6.

Equations 46 and 47

See *Oxyhemoglobin dissociation curve (ODC)*.

mOsm - equation 48

Ref. [11]

$$m\text{Osm} = 2c\text{Na}^+ + c\text{Glu}$$

Equations for oxygen parameters

pO₂(T) - equation 14

Refs. [12,13]:

The standard Oxygen Dissociation Curve (ODC) is used (i.e. p50(st) = 3.578 kPa) at actual values of pH, pCO₂, FCOHb, FMetHb, FHbF (see *Equations 46 and 47*).

pO₂(T) is calculated by a numerical method using:

$$t_i(T) = ct\text{Hb} \times (1 - \text{FCOHb} - \text{FMetHb}) \times s\text{O}_{2,i}(T) + \alpha\text{O}_2(T) \times p\text{O}_{2,i}(T)$$

where

Equation	Description	See...
14.1	$S = \text{ODC}(P,A,T)$	Eq. 47
14.2	$s\text{O}_{2,i}(T) = \frac{S \times (1 - \text{FMetHb}) - \text{FCOHb}}{1 - \text{FCOHb} - \text{FMetHb}}$	Eq. 46.12
14.3	$p\text{O}_{2,i}(T) = \frac{P}{\frac{\text{FCOHb}}{s\text{O}_{2,i}(T) \times (1 - \text{FCOHb} - \text{FMetHb})}}$	Eq. 46.10
14.4	$\alpha\text{O}_2 = 0.015e^{[-1.15 \times 10^{-2}(T-37.0) + 2.1 \times 10^{-4} \times (T-37.0)^2]}$	

Equation	Description	See...
14.5	P is the variable during iteration.	
14.6	$A = ac - 1.04 \times \frac{\partial pH}{\partial T} \times (T - 37.0)$	
14.7	T = patient temperature in °C (keyed-in).	
14.8	$\frac{\partial pH}{\partial T} = -1.47 \times 10^{-2} - 6.5 \times 10^{-3} \times (\text{pH}(37) - 7.40)$ When $t_i(T) = t_i(37.0)$, then $pO_{2,i}(T) = pO_2(T)$	

Changes in the equations for pH(T) and ctO₂ correspond to less than 0.5 % of pO₂(T) in the reference range for pH, pCO₂, pO₂ and ctHb and T in the interval 32-42 °C, using FHbF = 0.5 %.

pO₂(A) - equation 15

Ref. [3]:

$$pO_2(A) = FO_2(I) \times (p(\text{amb}) - 6.275) - pCO_2 \times [RQ^{-1} - FO_2(I) \times (RQ^{-1} - 1)]$$

If FO₂(I) and RQ are not keyed in, they are set to the default values.

The calculation requires that the sample type is entered as "Arterial" or "Capillary".

pO₂(A,T) - equation 16

Refs. [2,3,14]:

$$pO_2(A,T) = FO_2(I) \times [p(\text{amb}) - pH_2O(T)] - pCO_2(T) \times [RQ^{-1} - FO_2(I) \times (RQ^{-1} - 1)]$$

$$pH_2O(T) = 6.275 \times 10^{[2.36 \times 10^{-2} \times (T - 37.0) - 9.6 \times 10^{-5} \times (T - 37.0)^2]}$$

If FO₂(I) and RQ are not keyed in, they are set to the default values.

The calculation requires that the sample type is entered as "Arterial" or "Capillary".

pO₂(a)/FO₂(I) - equation 17

$$pO_2(a) / FO_2(I) = \frac{pO_2(a)}{FO_2(I)}$$

The calculation cannot be performed on the basis of the default FO₂(I) value, and the calculation requires that the sample type is entered as "Arterial" or "Capillary".

pO₂(a,T)/ FO₂(I) - equation 18

$$pO_2(a,T) / FO_2(I) = \frac{pO_2(a,T)}{FO_2(I)}$$

The calculation cannot be performed on the basis of the default FO₂(I) value, and the calculation requires that the sample type is entered as "Arterial" or "Capillary".

p50 - equation 19

Refer to equation 46.10.

The ODC is determined as described in *Equations 46 and 47*.

$$p50 = \frac{P}{1 + \frac{FCO_{Hb}}{0.5 \times (1 - FCO_{Hb} - FMetHb)}}$$

Where

Description	See...
$P = ODC(S,A,T)$	Eq. 47
$S = \frac{0.5 \times (1 - FCO_{Hb} - FMetHb) + FCO_{Hb}}{1 - FMetHb}$	Eq. 46.11
$A = a$	
$T = 37.0 \text{ }^\circ\text{C}$	Eq. 46.13

p50(T) - equation 20

The ODC is determined as described in *Equations 46 and 47*.

$$p50(T) = \frac{P}{1 + \frac{FCO_{Hb}}{0.5 \times (1 - FCO_{Hb} - FMetHb)}}$$

where

Description	See...
$P = ODC(S,A,T)$	Eq. 47
$S = \frac{0.5 \times (1 - FCO_{Hb} - FMetHb) + FCO_{Hb}}{1 - FMetHb}$	Eq. 46.11
$A = a - 1.04 \times \frac{\partial pH}{\partial T} \times (T - 37.0)$	
$\frac{\partial pH}{\partial T} = -1.47 \times 10^{-2} - 6.5 \times 10^{-3} \times (pH(37) - 7.40)$	
$T = \text{patient temperature in } ^\circ\text{C (keyed-in)}$	

p50(st) - equation 21

p50 is calculated for $pH = 7.40$, $pCO_2 = 5.33 \text{ kPa}$, $FCO_{Hb} = 0$, $FMetHb = 0$, $FHbF = 0$.

The ODC is determined as described in *Equations 46 and 47*.

$$p50(st) = ODC(S,A,T)$$

Where

Description	See...
$S = 0.5$	Eq. 46.11

Description	See...
A = a6 corresponds to pH = 7.40, $p\text{CO}_2 = 5.33$ kPa, $\text{FCO}_2\text{Hb} = 0$, $\text{FMetHb} = 0$, $\text{FHbF} = 0$	Eq. 46.13
$T = 37.0$ °C	

 $p\text{O}_2(\text{A-a})$ - equation 22

$$p\text{O}_2(\text{A-a}) = p\text{O}_2(\text{A}) - p\text{O}_2(\text{a})$$

The calculation requires that the sample type is entered as "Arterial" or "Capillary".

 $p\text{O}_2(\text{A-a},T)$ - equation 23

$$p\text{O}_2(\text{A-a},T) = p\text{O}_2(\text{A},T) - p\text{O}_2(\text{a},T)$$

The calculation requires that the sample type is entered as "Arterial" or "Capillary".

 $p\text{O}_2(\text{a/A})$ - equation 24

$$p\text{O}_2(\text{a/A}) = \frac{p\text{O}_2(\text{a})}{p\text{O}_2(\text{A})}$$

The calculation requires that the sample type is entered as "Arterial" or "Capillary".

 $p\text{O}_2(\text{a/A},T)$ - equation 25

$$p\text{O}_2(\text{a/A},T) = \frac{p\text{O}_2(\text{a},T)}{p\text{O}_2(\text{A},T)}$$

The calculation requires that the sample type is entered as "Arterial" or "Capillary".

 $p\text{O}_2(\text{x})$ or p_x - equation 26

Ref. [6]:

The ODC is determined as described in *Equations 46 and 47*.

$p\text{O}_2(\text{x})$ is calculated by a numerical method, with the use of these equations:

Equation	Description	See...
26.1	$S = \text{ODC}(P, A, T)$	Eq. 47
26.2	$s\text{O}_{2,i} = \frac{S \times (1 - \text{FMetHb}) - \text{FCO}_2\text{Hb}}{1 - \text{FCO}_2\text{Hb} - \text{FMetHb}}$	Eq. 46.12
26.3	$p\text{O}_{2,i} = \frac{P}{1 + \frac{\text{FCO}_2\text{Hb}}{s\text{O}_{2,i} \times (1 - \text{FCO}_2\text{Hb} - \text{FMetHb})}}$	Eq. 46.10
26.4	$t_i = \text{ctHb} \times (1 - \text{FCO}_2\text{Hb} - \text{FMetHb}) \times s\text{O}_{2,i} + 0.0105 \times p\text{O}_{2,i}$	
26.5	$A = a$	
26.6	$T = 37$ °C	

When $t_i = \text{ctO}_2 - 2.3$ mmol/L, then $p\text{O}_{2,i} = p\text{O}_2(\text{x})$, where ctO_2 is determined as described in equation 27.

$pO_2(x)$ cannot be calculated on the basis of a default ctHb value.

$pO_2(x)$ can only be calculated if the measured $sO_2(a) \leq 0.97$.

The calculation requires that the sample type is entered as "Arterial" or "Capillary".

$pO_2(x,T)$ - equation 50

Ref. [6,14]

The ODC is determined as described in *Equations 46 and 47*.

$pO_2(x)$ is calculated by a numerical method, with the use of these equations:

Equation	Description	See...
50.1	$S = ODC(P,A,T)$	Eq. 47
50.2	$sO_{2,i}(T) = \frac{S \times (1 - FMetHb) - FCOHb}{1 - FCOHb - FMetHb}$	Eq. 46.12
50.3	$pO_{2,i}(T) = \frac{P}{1 + \frac{FCOHb}{sO_{2,i}(T) \times (1 - FCOHb - FMetHb)}}$	Eq. 46.10
50.4	$t_i(T) = ctHb \times (1 - FCOHb - FMetHb) \times sO_{2,i}(T) + \alpha O_2(T) \times pO_{2,i}(T)$	
50.5	$A = a - 1.04 \times \frac{\partial pH}{\partial T} \times (T - 37.0)$	Eq. 20
50.6	$T = \text{patient temperature}$	
50.7	$\alpha O_2(T) = 0.0105e^{[-0.115 \times (T - 37) + 21 \times 10^{-5} \times (T - 37)^2]}$	
50.8	$pO_{2,i} = pO_2(x,T)$ when $t_i(T) = ctO_2(37^\circ C) - 2.3 \text{ mmol/L}$	

$pO_2(x,T)$ is calculated in accordance with OSA V3.0.

$pO_2(x,T)$ can only be calculated if the measured $sO_2(a) \leq 0.97$.

$pO_2(x,T)$ is tagged with ? if any of the following parameters: sO_2 , $FMetHb$, $FCOHb$, pO_2 , pCO_2 , pH or ctHb is tagged with ?.

The calculation requires that the sample type is entered as "Arterial" or "Capillary".

ctO₂ - equation 27

Ref [3]:

$$ctO_2 = \alpha O_2 \times pO_2 + sO_2 \times (1 - FCOHb - FMetHb) \times ctHb$$

αO_2 is the concentrational solubility coefficient for O₂ in blood (here set to 0.0105 mmol/L/kPa at 37 °C [5]).

ctO₂ cannot be calculated on the basis of a default ctHb value.

Note: The equation is different from that of previous Radiometer analyzers. The oxygen solubility coefficient is now changed from 0.00983 to 0.0105 to be in accordance with NCCLS (CLSI)-approved guidelines [5].

The change corresponds to 0.00067 mmol/L/kPa.

ctO₂(a- \bar{v}) - equation 28

$$ctO_2(a-\bar{v}) = ctO_2(a) - ctO_2(\bar{v})$$

where $ctO_2(a)$ and $ctO_2(\bar{v})$ are calculated from equation 27 for arterial and mixed venous blood, respectively. The calculation requires two measurements and input of both $pO_2(\bar{v})$ and $sO_2(\bar{v})$.

BO₂ - equation 29

Ref. [15]:

$$BO_2 = ctHb \times (1 - FCOHb - FMetHb)$$

BO_2 cannot be calculated on the basis of a default ctHb value.

ctO₂(x) or c_x - equation 30

Ref. [6]:

The ODC is determined, as described in *Equations 46 and 47*.

$$ctO_2(x) = ctO_2(a) - t_i$$

where

Equation	Description	See...
30.1	$t_i = ctHb \times (1 - FCOHb - FMetHb) \times sO_{2,i} + 0.0105 \times pO_2(5)$	
30.2	$pO_2(5) = 5.00 \text{ kPa}$	
30.3	$S = ODC(P,A,T)$	Eq. 47
30.4	$P = pO_2(5) \times \left[1 + \frac{FCOHb}{sO_{2,i} \times (1 - FCOHb - FMetHb)} \right]$	Eq. 46.9
30.5	$sO_{2,i} = \frac{S \times (1 - FMetHb) - FCOHb}{1 - FCOHb - FMetHb}$	Eq. 46.12
30.6	$A = a$	
30.7	$T = 37.0 \text{ }^\circ\text{C}$	

$ctO_2(a)$ is determined as described in equation 27.

$ctO_2(x)$ cannot be calculated on the basis of a default ctHb value.

$ctO_2(x)$ can only be calculated if the measured $sO_2(a) \leq 0.97$.

The calculation requires that the sample type is entered as "Arterial" or "Capillary".

 $\dot{D}O_2$ - equation 31

$$\dot{D}O_2 = ctO_2 \times \dot{Q}_t$$

\dot{Q}_t is the cardiac output and is an input parameter for the calculation of $\dot{D}O_2$.

If \dot{Q}_t is not keyed in, $\dot{D}O_2$ will not be calculated.

The calculation requires that the sample type is entered as "Arterial" or "Capillary".

\dot{Q}_t - equation 32

$$\dot{Q}_t = \frac{\dot{V}O_2}{ctO_2(a-\bar{v})}$$

If $\dot{V}O_2$ is not keyed in, \dot{Q}_t will not be calculated.

$\dot{V}O_2$ - equation 33

$$\dot{V}O_2 = \dot{Q}_t \times ctO_2(a-\bar{v})$$

If \dot{Q}_t is not keyed in, $\dot{V}O_2$ will not be calculated.

FShunt - equation 34

Ref. [3]:

$$FShunt = \frac{ctO_2(c) - ctO_2(a)}{ctO_2(c) - ctO_2(\bar{v})}$$

Equation	Description
34.1	$FShunt \cong \frac{ctO_2(A) - ctO_2(a)}{ctO_2(A) - ctO_2(\bar{v})}$
34.2	$FShunt = \left[1 + \frac{ctO_2(a) - ctO_2(\bar{v})}{ctO_2(A) - ctO_2(a)} \right]^{-1}$ <p>where:</p> <p>ctO₂(c): total oxygen in pulmonary capillary blood ctO₂(a): total oxygen in arterial blood ctO₂(A): total oxygen in alveolar air. Oxygen tension = pO₂(A). ctO₂(\bar{v}): total oxygen in mixed venous blood</p>
34.3	$ctO_2(a) = 0.0105pO_2(a) + ctHb \times (1 - FCOHb - FMetHb) \times sO_2(a)$
34.4	$ctO_2(A) = 0.0105pO_2(A) + ctHb \times (1 - FCOHb - FMetHb) \times sO_2(A)$

Equation	Description
34.5	$ctO_2(\bar{v}) = 0.0105pO_2(\bar{v}) + ctHb \times (1 - FCOHb - FMetHb) \times sO_2(\bar{v})$ <p>where:</p> <p>$pO_2(a)$: oxygen tension in arterial blood; measured</p> <p>$pO_2(A)$: oxygen tension in alveolar blood. See equation 15.</p> <p>$pO_2(\bar{v})$: oxygen tension in mixed venous blood; measured and then entered</p> <p>$sO_2(a)$: oxygen saturation in arterial blood; can be measured</p> <p>$sO_2(A)$: oxygen saturation in (alveolar) blood calculated from equation 39 where $P = pO_2(A)$</p> <p>$sO_2(\bar{v})$: oxygen saturation in mixed venous blood; measured and then entered</p> <p>The calculation requires that the sample type is entered as "Arterial" or "Capillary"</p> <p>If $sO_2(a) > 0.97$, the default value (3.578 kPa) will be used to estimate the ODC.</p> <p>If no venous sample is measured, $FShunt$ is estimated assuming:</p> $ctO_2(a) - ctO_2(\bar{v}) = 2.3 \text{ mmol/L in equation 34.2}$

***FShunt(T)* - equation 35**

Refs. [3, 12]:

$$FShunt(T) = \left[1 + \frac{ctO_2(a,T) - ctO_2(\bar{v},T)}{ctO_2(A,T) - ctO_2(a,T)} \right]^{-1}$$

where:

$ctO_2(a,T)$: total oxygen in arterial blood at patient temperature

$ctO_2(A,T)$: total oxygen in alveolar blood at patient temperature

$ctO_2(\bar{v},T)$: total oxygen in mixed venous blood at patient temperature

Equation	Description
35.1	$ctO_2(a,T) = ctO_2$ calculated from equation 25 for arterial pO_2 and sO_2 values at 37 °C
35.2	$ctO_2(A,T) = \alpha O_2(T) \times pO_2(A,T) + ctHb \times (1 - FCOHb - FMetHb) \times sO_2(A,T)$
35.3	$\alpha O_2(T) = 0.0105e^{[-1.15 \times 10^{-2} \times (T - 37.0) + 2.1 \times 10^{-4} \times (T - 37.0)^2]}$
35.4	$pO_2(A,T)$ is calculated from equation 16
35.5	$sO_2(A,T) = S$
35.6	$S = ODC(P,A,T)$ See equation 47
35.7	$P = pO_2(A,T)$
35.8	$A = a - 1.04 \times \frac{\partial pH}{\partial T} \times (T - 37.0)$
35.9	$T =$ patient temperature (keyed-in)

Equation	Description
35.10	$\frac{\partial pH}{\partial T} = -1.47 \times 10^{-2} - 6.5 \times 10^{-3} \times (\text{pH}(37) - 7.40)$ <p>If $sO_2(a) > 0.97$, the default $p50(st)$ (3.578 kPa) will be used to determine the ODC.</p>
35.11	<p>$ctO_2(\bar{v}, T) = ctO_2(\bar{v})$ at 37 °C is calculated from equation 27 for mixed venous blood values of pO_2 and sO_2.</p> <p>If no mixed venous sample is measured, the $FShunt(T)$ is estimated assuming $ctO_2(a, T) - ctO_2(\bar{v}, T) = 2.3$ mmol/L in equation 35.</p>

RI - equation 36

$$RI = \frac{pO_2(A) - pO_2(a)}{pO_2(a)}$$

The calculation requires that the sample type is entered as "Arterial" or "Capillary".

RI(T) - equation 37

$$RI(T) = \frac{pO_2(A, T) - pO_2(a, T)}{pO_2(a, T)}$$

The calculation requires that the sample type is entered as "Arterial" or "Capillary".

Q_x - equation 38

Ref. [6]:

The ODC is determined as described in *Equations 46 and 47*.

$$Q_x = \frac{2.3}{ctO_2(a) - t_i}$$

Equation	Description	See...
38.1	$t_i = ctHb \times (1 - FCOHb - FMetHb) \times sO_{2,i} + 0.0105pO_2(5)$	
38.2	$pO_2(5) = 5.00$ kPa	
38.3	$S = ODC(P, A, T)$	
38.4	$P = pO_2(5) \times \left[1 + \frac{FCOHb}{sO_{2,i} \times (1 - FCOHb - FMetHb)} \right]$	Eq. 46.9
38.5	$sO_{2,i} = \frac{S \times (1 - FMetHb) - FCOHb}{1 - FCOHb - FMetHb}$	Eq. 46.12
38.6	$A = a$	
38.7	$T = 37.0$ °C	

$ctO_2(a)$ is determined as described in equation 27

Q_x cannot be calculated on the basis of a default $ctHb$ value

Q_x can only be calculated if the measured $sO_2(a) \leq 0.97$

The calculation requires that the sample type is entered as "Arterial" or "Capillary"

V(B) - equation 42

Ref. [3]:

$$V(B) = \frac{V(CO)}{24 \times (FCO_{Hb}(2) - FCO_{Hb}(1)) \times 0.91 \times ctHb}$$

Equation	Description
42.1	$V(B) = \frac{V(CO)}{21.84 \times (FCO_{Hb}(2) - FCO_{Hb}(1)) \times ctHb}$
42.2	$V(CO)$ = volume (in mL) of carbon monoxide injected according to the procedure and the value keyed in
42.3	$FCO_{Hb}(1)$ = fraction of COHb measured before the CO injection
42.4	$FCO_{Hb}(2)$ = fraction of COHb measured after the CO injection

$VCO_2/V(\text{dry air})$ - equation 51

$$VCO_2 / V(\text{dry air}) = \frac{pCO_2}{p(\text{amb}) - 6.275}$$

$VO_2/V(\text{dry air})$ - equation 52

$$VO_2 / V(\text{dry air}) = \frac{pO_2}{p(\text{amb}) - 6.275}$$

Equations for oximetry parameters

FHHb - equation 41

$$FHHb = 1 - sO_2 \times (1 - FCO_{Hb} - FMetHb) - FCO_{Hb} - FMetHb$$

If sO_2 is not measured, it will be calculated from equation 39.

If dyshemoglobins (FCO_{Hb} , $FMetHb$) are not known, they are set to the default values.

FO_2Hb - equation 40

$$FO_2Hb = sO_2 \times (1 - FCO_{Hb} - FMetHb)$$

If sO_2 is not measured, it will be calculated from equation 39.

If dyshemoglobins (FCO_{Hb} , $FMetHb$) are not known, they are set to the default values.

sO_2 - equation 39

The ODC is determined as described in *Equations 46 and 47* (points I and III).

$$sO_2 = \frac{S \times (1 - F\text{MetHb}) - F\text{COHb}}{1 - F\text{COHb} - F\text{MetHb}}$$

Where

Description	See...
$S = \text{ODC}(P,A,T)$	
$P = pO_2 + \frac{pO_2 \times F\text{COHb}}{sO_2 \times (1 - F\text{COHb} - F\text{MetHb})}$	Eq. 46.9
$A = a$	
$T = 37.0 \text{ }^\circ\text{C}$	

Hct - equation 13

Ref. [15]:

$$\text{Hct} = 0.04939 \times \text{ctHb}$$

Hct cannot be calculated on the basis of a default ctHb value.

Note: The equation is different from that of previous Radiometer analyzers. The previous equation $\text{Hct} = 0.0485 \times \text{ctHb} + 8.3 \times 10^{-3}$ was changed to ensure that $\text{Hct} = 0$ when $\text{ctHb} = 0$. The slope was adjusted to make Hct identical for the two equations when $\text{ctHb} = 9.3087 \text{ mmol/L}$.

The change corresponds to 1 % in the ctHb range 6.3-12.3.

FHbF - equation 49

An iterative method is used to calculate FHbF. The input parameters are sO_2 , ceHb (effective hemoglobin concentration) and $cO_2\text{HbF}$ (concentration of fetal oxyhemoglobin).

In the calculations the following are assumed: $\text{pH} = 7.4$, $p\text{CO}_2 = 5.33 \text{ kPa}$, $F\text{COHb} = 0$, $F\text{MetHb} = 0$, $c\text{DPG} = 5 \text{ mmol/L}$, and $\text{temp} = 37 \text{ }^\circ\text{C}$.

Equation	Description	See...
49.1	An estimate of FHbF is made: $F\text{HbF}_{\text{est}} = 0.8$	
49.2	$pO_{2,\text{est}} = \text{ODC}(sO_2,A,T)$; where the constant A depends on $F\text{HbF} = F\text{HbF}_{\text{est}}$	Eq. 47
49.3	sO_2 (for fetal blood) = $\text{ODC}(pO_{2,\text{est}},A,T)$; where $F\text{HbF} = 1$	Eq. 47
49.4	$cO_2\text{HbF}_{\text{est}} = sO_2$ (fetal blood) \times ceHb $\times F\text{HbF}_{\text{est}}$	
49.5	$\Delta F\text{HbF}_{\text{est}} = \frac{cO_2\text{HbF}_{\text{meas.}} - cO_2\text{HbF}_{\text{est}}}{\text{ceHb}}$	
49.6	If $ \Delta F\text{HbF}_{\text{est}} \geq 0.001$, proceed to equation 49.7. If $ \Delta F\text{HbF}_{\text{est}} < 0.001$, proceed to equation 49.9.	

Equation	Description	See...
49.7	$FHbF_{est,new} = FHbF_{est,old} + \Delta FHbF_{est}$	
49.8	Return to equation 49.2.	
49.9	End of iteration. The value for $FHbF$ has converged.	

Related information

Calculation of the values of the oximetry parameters, page 367

Converting results to other units

You can use the equations in the table to convert results to other units.

Parameter	Unit	Equation to convert
Temperature (T)	T °F	= $9/5 (T$ °C) + 32
	T °C	= $5/9 (T$ °F - 32)
cK^+ , cNa^+ , cCl^-	cX (meq/L)	= cX (mmol/L) where X is K^+ , Na^+ or Cl^-
cCa^{2+}	cCa^{2+} (meq/L)	= $2 \times cCa^{2+}$ (mmol/L)
	cCa^{2+} (mg/dL)	= $4.008 \times cCa^{2+}$ (mmol/L)
	cCa^{2+} (mmol/L)	= $0.5 \times cCa^{2+}$ (meq/L)
	cCa^{2+} (mmol/L)	= $0.2495 \times cCa^{2+}$ (mg/dL)
Pressure	p (mmHg)	= p (Torr) = $7.500638 \times p$ (kPa)
	p (kPa)	= $0.133322 \times p$ (mmHg) = $0.133322 \times p$ (Torr)
ctHb*	ctHb (g/dL)	= $1.61140 \times ctHb$ (mmol/L)
	ctHb (g/L)	= $16.1140 \times ctHb$ (mmol/L)
	ctHb (mmol/L)	= $0.62058 \times ctHb$ (g/dL)
	ctHb (mmol/L)	= $0.062058 \times ctHb$ (g/L)
ctCO ₂ , ctO ₂ , ctO ₂ (a- \bar{v}), BO ₂	Vol %	= $2.241 \times$ (mmol/L)
	Vol %	= mL/dL
	mmol/L	= $0.4462 \times$ (mL/dL)
$\dot{V}O_2$	$\dot{V}O_2$ mmol/min	= $\dot{V}O_2/22.41$ mL/min
cGlu***	cGlu (mg/dL)	= $18.016 \times cGlu$ (mmol/L)
	cGlu (mmol/L)	= $0.055506 \times cGlu$ (mg/dL)
cLac**/**	cLac (mg/dL)	= $9.008 \times cLac$ (mmol/L)
	cLac (mmol/L)	= $0.11101 \times cLac$ (mg/dL)
	cLac (meq/L)	= cLac (mmol/L)
cCrea*****	cCrea (μ mol/L)	= $88.4 \times cCrea$ (mg/dL)
	cCrea (mg/dL)	= $0.011312 \times cCrea$ (μ mol/L)

Parameter	Unit	Equation to convert
ctBil****	ctBil (μmol/L)	= 17.1 × ctBil (mg/dL)
	ctBil (μmol/L)	= 1.71 × ctBil (mg/L)
	ctBil (mg/dL)	= 0.0585 × ctBil (μmol/L)
	ctBil (mg/L)	= 0.585 × ctBil (μmol/L)

* See [2].

** cLac conversion is based on the molecular weight of lactic acid.

*** See [16].

**** Bilirubin can only be measured on neonatal samples. This parameter is only available in the Neonate blood analysis 65 μL mode.

***** Available with software featuring Creatinine and Urea.

Oxyhemoglobin dissociation curve

ODC equations

These equations account for the effect of FCOHb on the shape of the Oxyhemoglobin Dissociation Curve (ODC) in accordance with the Haldane equation.

Equation 46 - Ref. [12,14]:

$$y - y^0 = (x - x^0) + h \times \tanh[k^0(x - x^0)]$$

where $k^0 = 0.5343$

Equation	Description
46.1	$x = \ln p$
46.2	$y = \ln \frac{s}{1-s}$
46.3	$y^0 = \ln \frac{s^0}{1-s^0}$ where $s^0 = 0.867$
46.4	$x^0 = x^{00} + a + b = \ln(p^{00}) + a + b$ where $p^{00} = 7 \text{ kPa}$.

The actual position of the ODC in the coordinate system ($\ln(s/(1-s))$ vs $\ln(p)$) used in the mathematical model, is expressed by equations 46.3 and 46.4.

The symbols a and b reflect the ODC displacement from the reference position to its actual position in this coordinate system:

a describes the displacement at 37 °C.

b the additional displacement due to the patient temperature difference from 37 °C.

The ODC reference position

The reference position of the ODC was chosen to be the one that corresponds to the default value for $p50(st) = 3.578$ kPa, which is traditionally considered the most likely value of $p50$ for adult humans under standard conditions, namely:

$$pH = 7.40; pCO_2 = 5.33 \text{ kPa}; FCOHb, FMetHb, FHbF = 0; cDPG = 5 \text{ mmol/L.}$$

The ODC displacement

The ODC displacement which is described by a and b in the coordinate system ($\ln(s/(1-s))$ vs $\ln(p)$), is given by the change in $p50$ from the default to its actual value in a more common coordinate system (sO_2, pO_2).

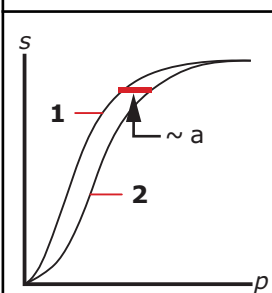
Equation	Description
46.5	$x - x^\circ = \ln \frac{p}{7} - a - b$
46.6	$h = h^0 + a$, where $h^0 = 3.5$
46.7	$b = 0.055 \times (T - T^\circ)$ $T^\circ = 37 \text{ }^\circ\text{C}$
46.8	$p = pO_2 + M \times pCO$ where $M \times pCO$ is taken from the Haldane equation [17]: $\frac{pO_2}{cO_2Hb} = M \times \frac{pCO}{cCOHb}$ to give equation 46.9
46.9	$p = pO_2 + \frac{pO_2}{sO_2} \times \left[\frac{FCOHb}{1 - FCOHb - FMetHb} \right]$ or equation 46.10
46.10	$pO_2 = \frac{p}{1 + \frac{FCOHb}{sO_2 \times (1 - FCOHb - FMetHb)}}$
	<div style="display: flex; align-items: center;">  <div style="margin-left: 20px;"> <p>The ordinate, s, may loosely be termed the combined oxygen/carbon monoxide saturation of hemoglobin and is described by equation 46.11.</p> <p>1 = Reference position 2 = Actual position</p> </div> </div>
46.11	$s = \frac{cO_2Hb + cCOHb}{cO_2Hb + cCOHb + cHHb}$ <p>or</p> $s = \frac{sO_2 \times (1 - FCOHb - FMetHb) + FCOHb}{1 - FMetHb}$
46.12	$sO_2 = \frac{s \times (1 - FMetHb) - FCOHb}{1 - FCOHb - FMetHb}$

The actual ODC position

The actual position of the ODC at 37 °C for a given sample is, in principle, determined in two steps:

1. The calculation of the combined effect on the ODC position at 37 °C of all known causes for displacement (= a_c in equation 46.13), and based on this position.
2. The computation by a numerical method of the actual position of the ODC curve by shifting it to pass through the known set of coordinates (P_0, S_0).

Equation	Description
46.13	$a = a_c + a_6$
46.14	$a_c = a_1 + a_2 + a_3 + a_4 + a_5$
46.15	$a_1 = -0.88 \times (\text{pH} - 7.40)$
46.16	$a_2 = 0.048 \times \ln \frac{p\text{CO}_2}{5.33}$
46.17	$a_3 = -0.7 \times F\text{MetHb}$
46.18	$a_4 = (0.06 - 0.02F\text{HbF}) \times (c\text{DPG} - 5)$
46.19	$a_5 = -0.25 \times F\text{HbF}$

To determine the actual displacement

- pO_2 , sO_2 can be used. If $sO_2 > 0.97$, the calculation is based on the calculation in steps 2 or 3.

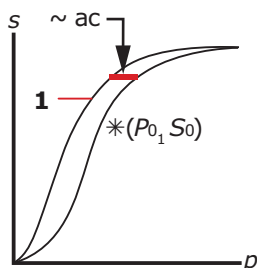

1 = Reference position

Coordinates (P_0, S_0) are calculated from equations 46.9 and 46.11. If FCOHb and FMetHb are not known, the default values are used.

The ODC is shifted from the reference position to a position that corresponds to the effect of all measured parameters according to step 1. The magnitude of the shift is ac . The ODC is then further shifted to pass through the point P_0, S_0 . The magnitude of the shift is a_6 .

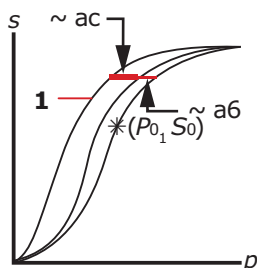

1 = Reference position

- $sO_2 > 0.97$ (or erroneous) and $p50(st)$ is known. Coordinates (P_0, S_0) are calculated from $(p50(st), 0.5)$ with the use of equations 46.9 and 46.11. Reference position of the ODC.

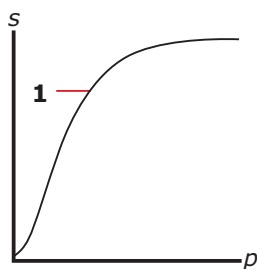

1 = Reference position

The ODC is shifted from the reference position to pass through the point (P_0, S_0) . In this position, the ODC reflects the $p50(st)$ of the patient, i.e., the particular patient but at standard conditions.

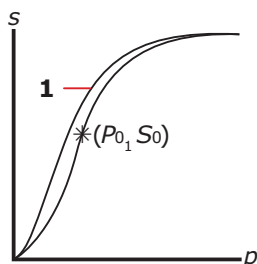

1 = Reference position

The ODC is further shifted, as determined by the effect of the measured parameters (ac), to its actual position. This position reflects the $p50(\text{act})$ of the patient.

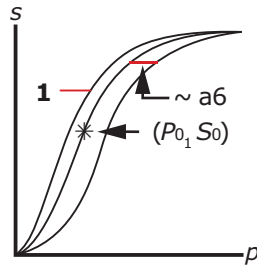

1 = Reference position

3. $sO_2 > 0.97$ (or erroneous). Reference position of the ODC.

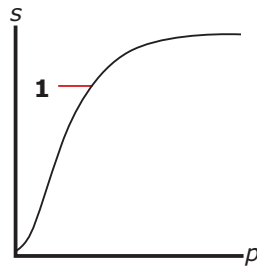

The position of the actual ODC can now be approximated from the reference position, using the actual values of pH, pCO_2 , FCOHb, FMetHb and FHbF to determine the shift ac.

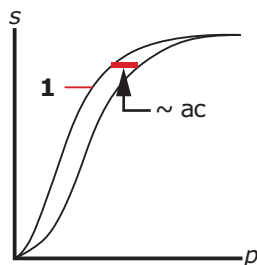

1 = Reference position

Note: The curves are used only to illustrate the principles of the ODC determination.

Coordinates on the ODC

Calculation of a set of coordinates on the ODC is symbolized by:

Equation 47:

$$S = \text{ODC}(P,A,T) \text{ or } P = \text{ODC}(S,A,T)$$

These equations are symbolic representations of the relationship between saturation (S), tension (P), displacement (A) and temperature (T).

To calculate S or P and to further calculate sO_2 and pO_2 , the other variables should be specified. S and P are calculated using numerical methods.

P is input to equation 46.1.

S is input to equation 46.2.

A is input to equation 46.5.

T is input to equation 46.7.

References

1. Wandrup JH. Physicochemical logic and simple symbol terminology of oxygen status. *Blood Gas News* 1993; 2,1: 9-11.
2. Siggaard-Andersen O. The acid-base status of the blood. 4th revised ed. Copenhagen: Munksgaard, 1976.
3. Siggaard-Andersen O, Wimberley PD, Fogh-Andersen N, Gøthgen IH. Measured and derived quantities with modern pH and blood gas equipment: calculation algorithms with 54 equations. *Scand J Clin Lab Invest* 1988; 48, Suppl 189: 7-15.
4. Burnett RW, Noonan DC. Calculations and correction factors used in determination of blood pH and blood gases. *Clin Chem* 1974; 20,12: 1499-1506.
5. Blood gas and pH analysis and related measurements; approved guideline. NCCLS (CLSI) document C46-A2, Vol. 29 No. 8, 2009.
6. Siggaard-Andersen O, Gøthgen IH, Wimberley PD, Fogh-Andersen N. The oxygen status of the arterial blood revised: relevant oxygen parameters for monitoring the arterial oxygen availability. *Scand J Clin Lab Invest* 1990; 50, Suppl 203: 17-28. Available as AS108.
7. Wandrup JH. Oxygen uptake in the lungs. *Blood Gas News* 1992; 1,1: 3-5.
8. Severinghaus JW. Blood gas calculator. *J Appl Physiol* 1966; 21,3: 1108-16. Available as ST36.
9. Christiansen TF. An algorithm for calculating the concentration of the base excess of blood. In: Siggaard-Andersen O, ed. Proceedings of the IFCC expert panel on pH and blood gases held at Herlev Hospital 1980. Copenhagen: Radiometer Medical A/S, 1981: 77-81.
10. Siggaard-Andersen O, Thode J, Wandrup JH. The concentration of free calcium ions in the blood plasma ionized calcium. In: Siggaard-Andersen O, ed. Proceedings of the IFCC expert panel on pH and blood gases held at Herlev Hospital 1980. Copenhagen: Radiometer Medical A/S, 1981: 163-90. Available as AS79.
11. Burton DR. Clinical physiology of acid-base and electrolyte disorders. 4th ed. New York: McGraw-Hill, 1994.
12. Siggaard-Andersen O, Wimberley PD, Gøthgen IH, Siggaard-Andersen M. A mathematical model of the hemoglobin-oxygen dissociation curve of human blood and of the oxygen partial pressure as a function of temperature. *Clin Chem* 1984; 30: 1646-51.
13. Siggaard-Andersen O, Wimberley PD, Gøthgen IH, Fogh-Andersen N, Rasmussen JP. Variability of the temperature coefficients for pH, pCO₂ and pO₂ in blood. *Scand J Clin Lab Invest* 1988; 48, Suppl 189: 85-88.
14. Siggaard-Andersen O, Siggaard-Andersen M. The oxygen status algorithm: a computer program for calculating and displaying pH and blood gas data. *Scand J Clin Lab Invest* 1990; 50, Suppl 203: 29-45.
15. Kokholm G. Simultaneous measurements of blood pH, pCO₂, pO₂ and concentrations of hemoglobin and its derivatives - a multicenter study. *Scand J Clin Lab Invest* 1990; 50, Suppl 203: 75-86. Available as AS107.
16. Olesen H et al. A proposal for an IUPAC/IFCC recommendation, quantities and units in clinical laboratory sciences. IUPAC/IFCC Stage 1, Draft 1, 1990: 1-361.
17. Roughton FJW, Darling RC. The effect of carbon monoxide on the oxyhemoglobin dissociation curve. *Am J Physiol* 1944; 141: 17-31.

General construction

Sensors

In this manual, the term sensor refers to an individual sensor as part of the sensing array within a Sensor Cassette. The electrical signal from each sensor is measured by proprietary analog electronics contained within the analyzer unit.

The sensors are located on sensor boards in the Sensor Cassette.

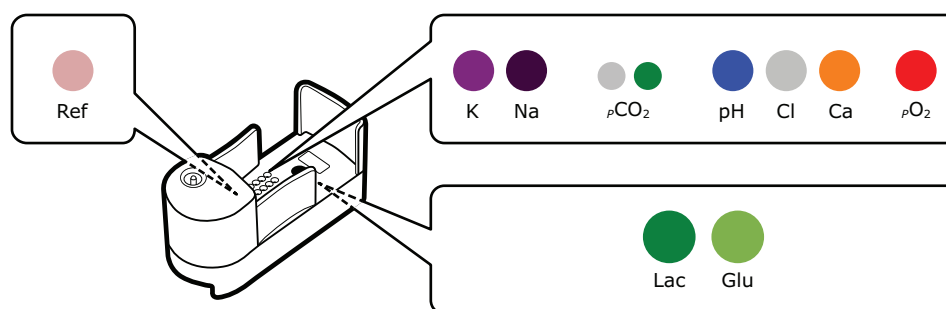

General measurement principles

Introduction

There are four different measuring principles employed in the sensors in the ABL90 FLEX analyzer.

- **Potentiometry:** The potential of an electrode chain is measured by a voltmeter, and related to the concentration of the sample (the Nernst equation). The potentiometric measuring principle is applied in the pH, $p\text{CO}_2$, K^+ , Na^+ , Ca^{2+} and Cl^- sensors.
- **Amperometry:** The magnitude of an electrical current that flows through an electrode chain is proportional to the concentration of the substance that is oxidized or reduced at a electrode in the chain. The amperometric measuring principle is applied in the cGlu and cLac sensors.
- **Optical $p\text{O}_2$:** The optical system for $p\text{O}_2$ is based on the ability of O_2 to reduce the intensity and time constant of the phosphorescence from a phosphorescent dye that is in contact with the sample. This measuring principle is applied in the $p\text{O}_2$ sensor.
- **Spectrophotometry:** Light passes through a cuvette that contains a hemolyzed blood sample. The absorption spectrum is used to calculate oximetry parameters. This measuring principle is used for ctHb, $s\text{O}_2$, FO_2Hb , FCOHb , FHHb , FMetHb and FHbF and ctBil*.

* Bilirubin can only be measured on neonatal samples. This parameter is only available in the Neonate blood analysis 65 μL mode.

Activity vs. concentration

Strictly speaking, in potentiometry the potential of an electrode chain is related to the activity of a substance not its concentration.

The activity of a substance can be considered the effective concentration of a species that takes non-ideality of the medium into account.

Activity and concentration are related by this equation:

$$a_x = \gamma c_x$$

where:

a_x = the activity of the species x

γ = the activity coefficient of species x under the measurement conditions (for ideal systems $\gamma = 1$)

c_x = the concentration of species x (mol/L)

Note: To be exact, activity is related to the molality of species x (the amount of substance of the solute (in mol), divided by the mass of the solvent (in kg)). However, molality is converted to concentration (molarity).

The analyzer automatically converts activities into concentrations. The term concentration is therefore used in explanations of the measuring principles for each of the sensors.

Fluid transport system

Patient samples and solutions necessary for calibration, QC measurements and other procedures are transported through the fluid transport system of the analyzer. The diagram shows the fluid transport system. The sample is aspirated from the inlet, transported through the Sensor Cassette and the oximetry module and into the waste pouch of the Solution Pack.

After a patient sample analysis the system is rinsed. The CAL 1 solution from the Solution Pack is used.

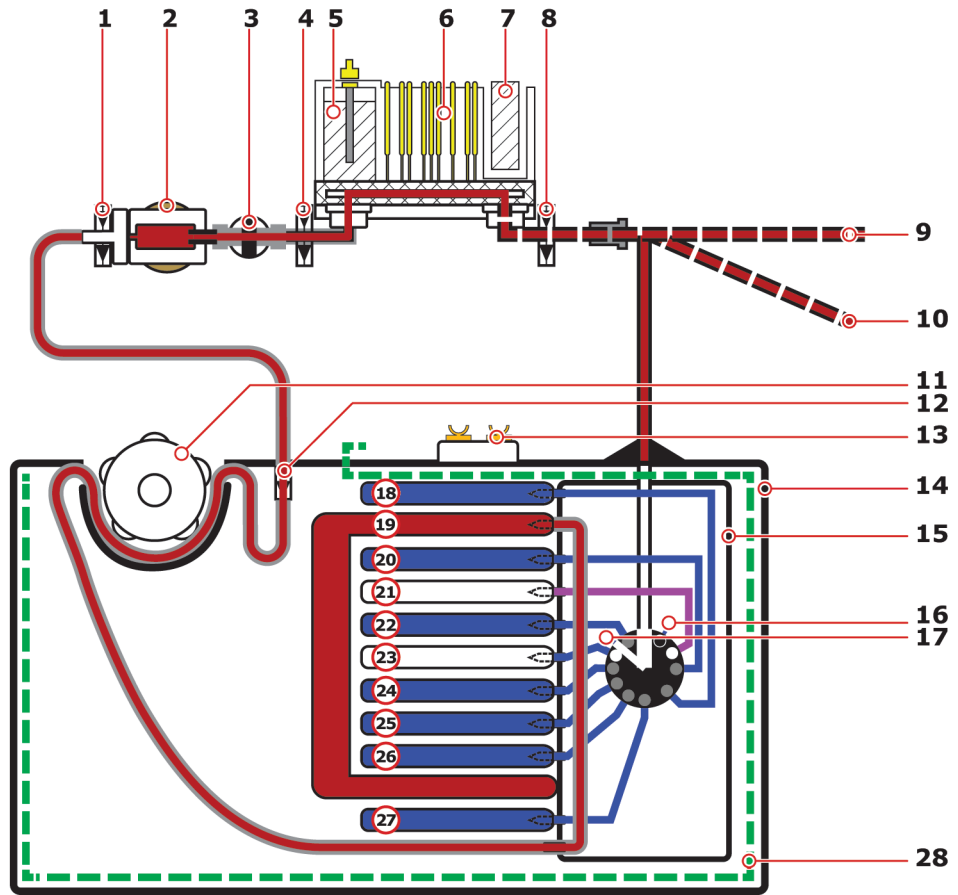

- | | |
|---|--|
| 1 Liquid sensor 3 | 15 Flow selector (to select a solution/gas) |
| 2 Hemolyzer | 16 Closed position (nothing selected) |
| 3 Oximetry valve | 17 Position to select air |
| 4 Liquid sensor 2 | 18 Pouch not in use |
| 5 Reference electrode | 19 Pouch to hold waste |
| 6 Sensor Cassette | 20 Pouch with CAL 3 solution |
| 7 Optical pO_2 sensor | 21 Pouch to hold clot waste |
| 8 Liquid sensor 1 | 22 Pouch with CAL 1 solution |
| 9 Sample inlet (position for capillary tubes) | 23 Pouch with gas mixture |
| 10 Sample inlet (position for syringes and test tubes) | 24 Pouch with QC 1 solution |
| 11 Peristaltic pump | 25 Pouch with CAL 2 solution |
| 12 Waste valve | 26 Pouch with QC 3 solution |
| 13 Smart chip | 27 Pouch with QC 2 solution |
| 14 Solution Pack | 28 Electrical shield |

Measurement process

The measurement process is similar for all types of measurement, patient sample analysis, built-in QC measurements, ampoule-based QC measurements, calibration-verification measurements and calibration measurements.

1. The sample (patient sample, QC solution or calibration solution) is aspirated or drawn into the sensor measurement chamber and the oximetry measurement chamber.
2. Measurements are done as soon as the sample is in the chambers. Liquid sensors control the process and can detect sample inhomogeneity and air bubbles in the sample. If any problems are found or the sample volume is too low, the measurement is aborted and the problem reported in a message attached to the result.
3. A rinse is done.
4. A status calibration is done for all parameters.

Rinse process

A rinse is done after a measurement is completed.

1. The sample is removed.
2. The system is rinsed with a mixture of solution and air/gas.
3. The system is filled with CAL1 to prepare for next sample.
During the rinse procedure, a check of the fluid transport system is done.

Calibration

Definition

Calibration is the process that relates the sensor signals during the calibration sequence to the values of the calibrating solutions and air. Calibration enables the sensor signals to be converted to the accurate values for an unknown sample.

Frequency

Automatic calibrations are scheduled by default to be done at regular intervals. This is necessary to compensate for small changes in the behavior of the sensors in the Sensor Cassette.

Calibration solutions

CAL 1, CAL 2 and CAL 3 solutions are used for the calibration of sensors. Air is used for the calibration of the pO_2 sensor.

The calibration solutions contain known concentrations of the parameters to be measured. These concentrations are necessary to determine the measurement results. The concentrations are automatically read from a chip on the Solution Pack when the Solution Pack is installed.

The calibration equation

About the calibration equation

The calibration equation expresses the relationship between the electrical measurement at a sensor and the concentration of the parameter specific to the sensor.

Plotting a calibration line

The calibration equation for each sensor is established during sensor calibration.

For the pH sensor, the relationship between potential and pH is linear. Thus, this type of sensor can be calibrated from the measurement of two solutions of known concentration. The measured potentials are plotted against the known concentrations and a line is drawn between them.

The calibration of the pH sensor shows how this equation is established.

- Solution 1 (s1), which has a pH of **7.40**, gives a measured potential of **2.3 mV**.
- Solution 2 (s2), which has a pH of **7.03**, gives a measured potential of **20.4 mV**.

These points are plotted on a graph and a line is drawn between them.

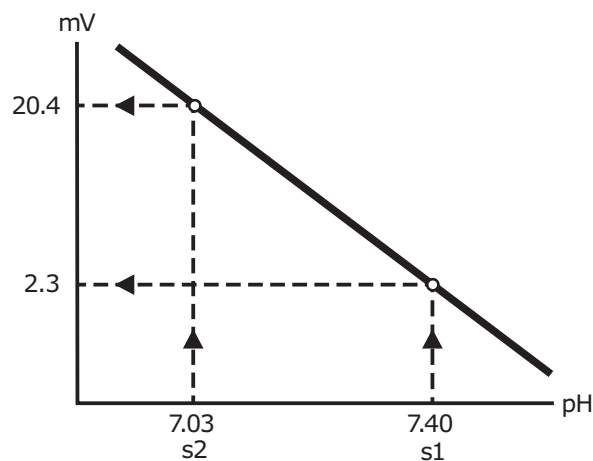

The calibration line is used to convert the potential measured at the pH sensor during sample analysis to an actual pH value.

For electrolyte sensors, ion concentrations are plotted on a log scale ($\log_{10}(a_{\text{ion}})$).

Sensitivity, status and drift

Sensitivity

The sensitivity value shown in calibration results shows how much the sensitivity of a sensor differs from the sensitivity of a theoretical sensor.

The sensitivity of a theoretical sensor is 100 %. If a sensor sensitivity is reported to be 95 %, its sensitivity is 5 % less than the theoretical sensor sensitivity.

The sensitivity of a sensor is the slope of its calibration line.

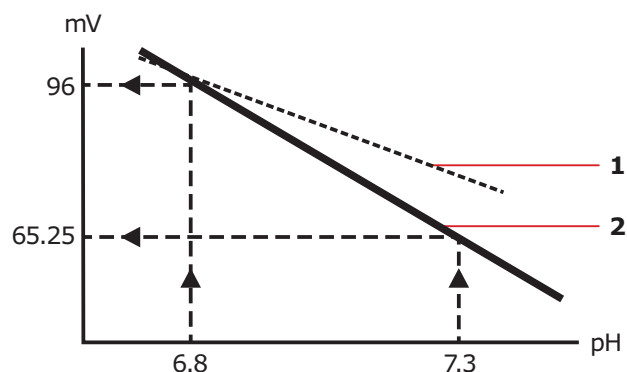

1 Calibration line for the sensor

Slope = -58.4 mV/pH

Sensitivity = 95 %

2 Calibration line for a theoretical sensor

Slope = -61.5 mV/pH

Sensitivity = 100 %

The sensitivity of a sensor is calculated as:

$$\text{Sensitivity} = \frac{\text{Potential at 6.8} - \text{Potential at 7.3}}{61.5 \times (7.3 - 6.8)} \quad (\%)$$

Where 61.5 = sensitivity of theoretical sensor.

Each sensor has its own sensitivity limits.

The sensitivities are range checked:

	pH	pCO ₂	pO ₂	cK ⁺	cNa ⁺	cCa ²⁺	cCl ⁻	cGlu	cLac
	%	%	%	%	%	%	%	pA/mmol/L	pA/mmol/L
Min.	85	60	85	85	85	85	75	100	100
Max.	105	105	110	105	105	105	105	2000	2000

The calibration line slope is re-established with every calibration.

A blood sample gives a measured potential of 4.8 mV at the pH sensor. This potential corresponds to a pH of 7.35 (see the diagram).

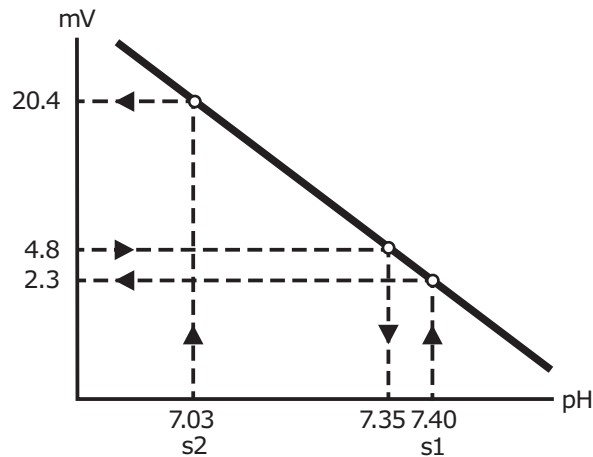

To compensate for deviations from ideal conditions (for example, residual rinse solution that dilutes a sample), a correction is applied to measurement results. Applied corrections are usually linear corrections.

Status

The calibration status values are, in general, defined as the sensor signals of CAL 1 except for pO_2 , which is only calibrated in one point (pO_2 status reflects the cal check).

Drift

Drift describes the variation in location of the calibration line between consecutive calibrations. A Status calibration is done with every measurement. This lets the analyzer automatically compensate for status drifts. Sensitivity drift is usually insignificant in comparison with status drift.

Reference electrode

Background information - reference electrode

Purpose

The purpose of the reference electrode is to provide a stable, fixed potential, against which the potential differences can be measured.

The potential of the reference electrode is not changed by the sample composition.

Fixed potential

A fixed potential is maintained at the reference electrode by these equilibrium reactions:

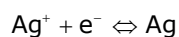
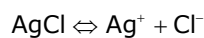

These reactions are possible because the electrode is made of an Ag rod coated with AgCl to provide the Ag/Ag⁺ equilibrium in a solution with constant Cl⁻ concentration and thus determining the reference potential.

Use

The reference electrode is used in the measurement of pH and electrolyte concentrations. Contact with the sample is made via a membrane junction between the reference electrode liquid chamber and the measuring chamber.

Construction - reference electrode

Construction

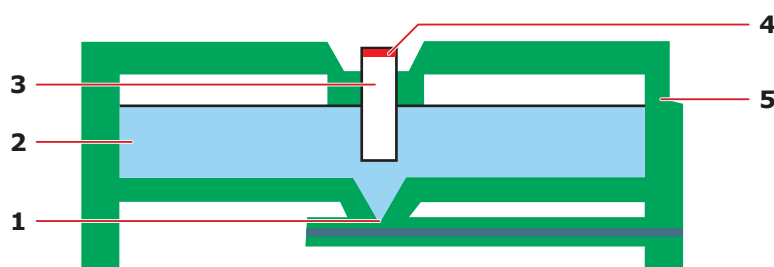

- | | |
|---|---|
| <p>1 Membrane – Interface to the sample</p> <p>2 Electrolyte solution – Acts as a salt-bridge solution that maintains an electrical contact between the electrode and the sample</p> <p>3 Electrode – Provides the contact between the electrolyte solution and the electrical contact</p> | <p>4 Electrical contact – The point of electrical contact between the electrode and the analyzer</p> <p>5 Housing – Sensor Cassette housing with integrated reference electrode</p> |
|---|---|

pH and electrolyte sensors

Construction - pH and electrolyte sensors

Construction

The pH and electrolyte sensors are of solid-state design with a H⁺, K⁺, Na⁺ and Ca²⁺ sensitive PVC membrane. The Cl⁻ sensor is of solid-state design with a Cl⁻ sensitive epoxy membrane.

The pH sensor is used as an example:

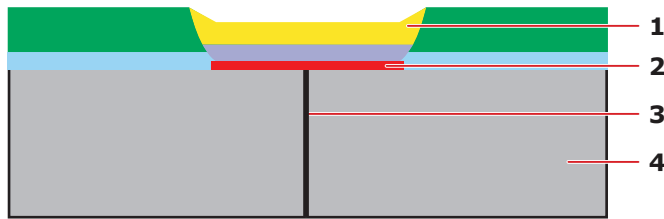

- | | |
|--|--|
| <p>1 Membrane – Ion-selective membrane that is in direct contact with the sample or calibration solution and that is sensitive to a specific ion, e.g. the H⁺ ions</p> <p>2 Solid-state contact – The point of electrical and ionic contact with the membrane</p> | <p>3 Electrical contact – The point of electrical contact between the sensor and the analyzer</p> <p>4 Sensor base – The structural platform on which the sensor is formed</p> |
|--|--|

Measurement principles - pH and electrolyte sensors

Potentiometric measurement principle

The pH and electrolyte sensors are measured according to the potentiometric measurement principle, where the potential of an electrode chain recorded at a voltmeter is related to the concentration of a substance via the Nernst equation.

Electrode chain

The electrode chain (or electrical circuit) set up to measure pH/electrolytes is shown in this diagram:

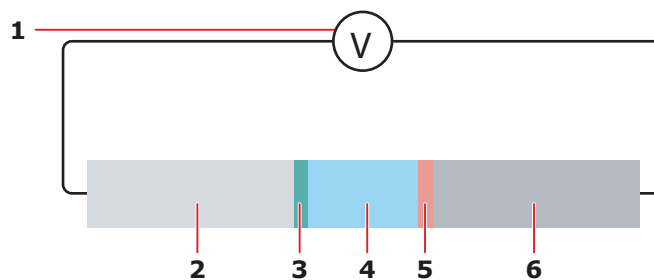

- | | |
|--|--|
| <p>1 Voltmeter – measures the potential in the circuit.</p> <p>2 Reference electrode – provides electrical connection to the voltmeter.</p> <p>3 Liquid junction – point of contact between the reference electrode and the sample.</p> | <p>4 Sample – the unknown liquid that is measured.</p> <p>5 Membrane – an ion-sensitive membrane, which is sensitive to H⁺/electrolyte ions.</p> <p>6 Solid-state contact – provides electrical connection to the voltmeter.</p> |
|--|--|

Electrode chain potential

Every element in the electrode chain contributes a voltage to the total potential drop through the chain.

The total potential across the electrode chain, therefore, is the sum of these separate potentials, all but one of which are known and constant, as outlined in the table:

Element	Potential	Symbol
Reference electrode	Known and constant when the Ag/AgCl is immersed in the electrolyte solution	E_{ref}
Liquid junction between the electrolyte solution in the reference electrode and the sample	Known and constant. Independent of sample composition .	E_{LJ}
Ion-sensitive membrane that separates the sample and the pH sensor	Unknown. Dependent on sample composition.	E_{Sample}
Solid-state contact	Known and constant	E_{E}
Total potential	Measured by the voltmeter	E_{tot}

Unknown potential

The unknown potential difference across the ion-sensitive PVC membrane is the difference between the measured total potential and the sum of the known potentials:

$$E_{\text{sample}} = E_{\text{total}} - (E_{\text{ref}} + E_{\text{LJ}} + E_{\text{E}})$$

Ion-sensitive membrane

The potential difference across the membrane arises as a consequence of a change in the charge balance at the membrane.

The membrane is sensitive to H^+ /electrolyte ions in that it has an ion-exchange ability. The internal solid-state reference electrode maintains the internal potential at the same level. Changes in the H^+ /electrolyte ions of the sample cause measurable changes in the overall potential.

Nernst equation

The potential difference across the membrane in the sensor can be expressed by the Nernst equation:

$$E_{\text{sample}} = E_0 + \frac{RT}{nF} \times \ln a_x$$

Where:

E_{Sample} = Potential between the reference electrode and the ion-sensitive membrane

E_0 = Reference electrode potential

R = Gas constant (8.3143 J/°K-mole)

T = Absolute temperature (°K)

n = Charge on the ion

F = Faraday constant (96487 C/mole)

a_x = Activity of the species x

Activity and concentration

The Nernst equation lets you calculate the activity of known concentrations of samples (pH and electrolytes).

The measured activities are used to calculate the concentrations by the use of the calibration results of the analyzer.

Calibration - pH and electrolyte sensors

Calibrations of pH and electrolyte sensors

The sensitivity calibration of the pH and electrolyte sensors gives the slopes of the calibration lines. Status calibrations are done with every measurement to compensate for small variations in sensor performance between calibrations.

Related information

Details about calibration frequency, page 175

Calculation of pH and electrolytes sensitivity

The sensitivity value shown in calibration results shows how much the sensitivity of a sensor differs from the sensitivity of a theoretical sensor.

The sensitivity is calculated as follows:

pH sensor sensitivity:

$$S = \frac{mV_{cal2} - mV_{cal1}}{-61.5mV \times (pH_{cal2} - pH_{cal1})}$$

Electrolyte sensor sensitivity:

$$S = \frac{n(mV_{cal2} - mV_{cal1})}{61.5mV \times \log_{10} \left(\frac{C_{cal2}}{C_{cal1}} \right)}$$

Where:

- S is the sensitivity
- mV_{cal1} and mV_{cal2} are the signals measured by the sensor and when CAL1 and CAL2 solutions are used
- C_{cal1} and C_{cal2} are the concentrations of the electrolyte in the CAL1 and CAL2 solutions
- n is the ionic charge

Status is defined as the sensor signal when CAL 1 solution is used.

Measurement - pH and electrolyte sensors

Calculation of pH and electrolyte values

The pH value measured from the sample is calculated as follows, from the sensor signal of the sample mV_{sample} :

$$\text{pH} = \text{pH}_{\text{cal1}} = \frac{mV_{\text{sample}} - mV_{\text{cal1}}}{-61.5\text{mV} \times S}$$

The electrolyte concentration in a sample is calculated from this equation:

$$c = c_{\text{cal1}} \times 10^{\frac{n(E_{\text{sample}} - E_{\text{cal1}})}{61.5\text{mV} \times S}}$$

where n is the ionic charge. The measured value is applied a linear correction:

$$c_{\text{displayed}} = k_1 \times c + k_2$$

Note: $c\text{Cl}^-$ is compensated for $c\text{HCO}_3^-$ interference by the use of the measured pH and $p\text{CO}_2$, before the linear correction is applied.

Sensor response stability

The sensor response stability is the standard deviation of the last 5 calculated status calibration values.

$p\text{CO}_2$ sensor

Construction - $p\text{CO}_2$ sensor

Construction

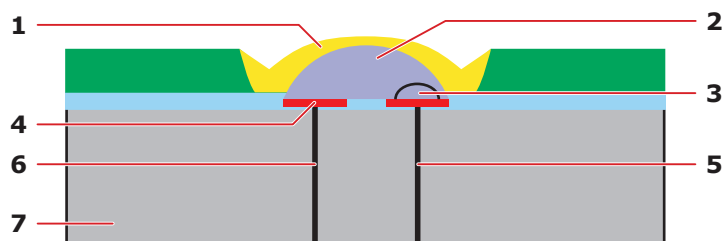

- | | |
|--|--|
| <p>1 Silicone membrane – A membrane that separates the sample and the electrolyte solution. Is only permeable to CO_2 and H_2O</p> <p>2 Electrolyte solution – A bicarbonate buffer that changes pH upon absorption/desorption of CO_2 from the sample</p> <p>3 pH membrane – H^+ sensitive membrane</p> <p>4 Reference electrode – Ag/AgCl electrode</p> | <p>5 Solid-state contact for the pH system. The point of electrical contact between the pH membrane and the analyzer.</p> <p>6 Electrical contact between the reference electrode and the analyzer</p> <p>7 Sensor base – The structural platform on which the sensor is formed</p> |
|--|--|

Measurement principle - pCO₂ sensor

Electrode chain

The electrode chain (or electrical circuit) set up to measure pCO₂ is shown in the diagram:

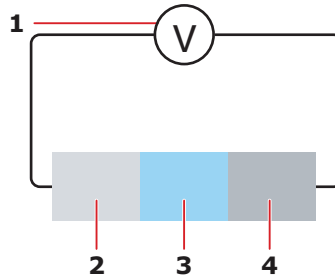

- | | |
|--|---|
| <p>1 Voltmeter – Measures the voltage potential in the circuit</p> <p>2 pH electrode – Provides electrical connection to the voltmeter</p> | <p>3 Electrolyte solution – Medium for connection</p> <p>4 Internal reference electrode (Ag/AgCl) – Provides electrical connection to the voltmeter</p> |
|--|---|

Electrode chain potential

The potential differences at all the junctions in the electrode chain are known and constant, except that at the pH-sensitive membrane. (See the section *pH and electrolyte sensors* for a full explanation.)

The potential difference at the pH-sensitive membrane depends on the pH of the electrolyte solution, which in turn depends on the CO₂ content of the sample. This is explained in the *Measuring process* topic.

Measurement process in the pCO₂ sensor

This is an account of the measurement process in the pCO₂ sensor.

Part	Function
Transport of CO ₂	CO ₂ from the sample permeates the membrane
Dissolution of CO ₂	The CO ₂ dissolves in the electrolyte solution. This produces carbonic acid: H ₂ O + CO ₂ ⇌ H ₂ CO ₃
Dissociation of carbonic acid	Carbonic acid dissociates according to the this equilibrium reaction: H ₂ CO ₃ ⇌ H ⁺ + HCO ₃ ⁻
pH change	The release of H ⁺ ions changes the H ⁺ concentration, and thus the pH of the inner buffer solution on one side of the pH-sensitive membrane
Measurement of potential	The concentration gradient of H ⁺ ions across the membrane creates a potential difference across the membrane. This change in potential across the membrane is measured by the voltmeter.

Part	Function
Relation of pH to $p\text{CO}_2$	<p>The pH value is related to the partial pressure of CO_2 in the sample by this equation:</p> $\text{pH} = \text{pK}_a + \log \frac{[\text{HCO}_3^-]}{\alpha \times p\text{CO}_2}$ <p>Where: $\text{pK}_a = -\log K_a$, the equilibrium constant for the dissociation of carbonic acid in water</p> <p>α = solubility coefficient for CO_2 in water</p> <p>The structure of the $p\text{CO}_2$ sensor is similar to the pH sensor, including the presence of a pH-sensitive membrane. The major difference is in the internal electrolyte solution present in the $p\text{CO}_2$ sensor which allows the dissolution of CO_2 and ultimate dissociation of carbonic acid mentioned above. If $[\text{HCO}_3^-]$ and α in the electrolyte solution are constant, it results in this equation: $\text{pH} = K - \log p\text{CO}_2$</p> <p>Where K contains the equilibrium constant pK_a, the solubility coefficient α and the concentration of bicarbonate $[\text{HCO}_3^-]$.</p> $E = E'_0 - 61.5 \times \text{pH} = E_0 + 61.5 \times \log p\text{CO}_2.$

Calibration - $p\text{CO}_2$ sensor

Calibrations of the $p\text{CO}_2$ sensor

The sensitivity calibration of the $p\text{CO}_2$ sensor gives the slope of the calibration line. Status calibrations are done with every measurement to compensate for small variations in sensor performance between calibrations.

Calibration levels

The ABL90 FLEX analyzer is equipped with a Solution Pack. This pack contains precision-tonometered fluids. The tonometry calibration gas mixture is of a known composition.

The partial pressure of CO_2 ($p\text{CO}_2$) and the solution pH values are known and contained in the Solution Pack smart chip.

Calculation of $p\text{CO}_2$ sensitivity

The sensitivity value shown in calibration results shows how much the sensitivity of a sensor differs from the sensitivity of a theoretical sensor.

The sensitivity is calculated as follows:

$$S = \frac{mV_{\text{cal2}} - mV_{\text{cal1}}}{61.5 \text{mV} \times \log_{10} \left(\frac{p\text{CO}_2(\text{cal2})}{p\text{CO}_2(\text{cal1})} \right)}$$

Where

- S is the sensitivity
- mV_{cal1} and mV_{cal2} are the signals measured by the sensor when CAL1 and CAL2 solutions are used
- $p\text{CO}_2(\text{cal1})$ and $p\text{CO}_2(\text{cal2})$ are the concentrations of $p\text{CO}_2$ in the CAL1 and CAL2 solutions

Status is defined as the sensor signal when CAL 1 solution is used.

Measurement - $p\text{CO}_2$ sensor

Calculation of $p\text{CO}_2$ values

The $p\text{CO}_2$ value measured from the sample is calculated as follows, from the sensor signal of the sample mV_{sample} :

$$p\text{CO}_2 = p\text{CO}_2(\text{cal1}) \times 10^{\frac{E_{\text{sample}} - E_{\text{cal1}}}{61.5 \text{mV} \times S}}$$

The measured value is applied as a linear correction:

$$C_{\text{displayed}} = k_1 \times c + k_2$$

Sensor response stability

The sensor response stability is the standard deviation of the last 5 calculated status calibration values.

$p\text{O}_2$ sensor

Measurement principle - $p\text{O}_2$ sensor

Optical system for $p\text{O}_2$

The optical system for $p\text{O}_2$ is based on the ability of O_2 to reduce the intensity and time constant of the phosphorescence from a phosphorescent dye that is in contact with the sample.

The optical system for $p\text{O}_2$ is shown in the diagram:

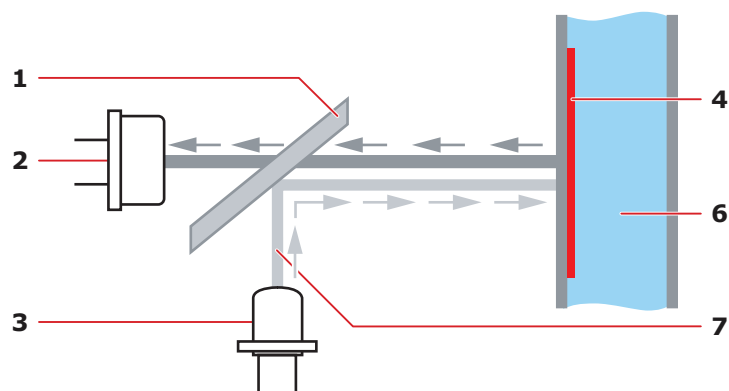

- | | | | |
|---|------------------------|---|------------------|
| 1 | Dichroic mirror | 5 | Phosphorescence |
| 2 | Photodetector | 6 | Sample |
| 3 | Green LED | 7 | Excitation light |
| 4 | pO ₂ sensor | | |

Measurement sequence

The green LED emits light, which is reflected by a dichroic mirror onto the pO₂ sensor. Due to the phosphorescence, red light is emitted back through the dichroic mirror and onto a photo detector. The photo detector sends the electrical signals, proportional to the light intensity, to the analog/digital converter and the data processing unit that calculates the pO₂ concentration.

Calculations

The pO₂ is calculated on the basis of the Stern-Volmer equation, which describes the relationship between the phosphorescence intensity/time constant (τ) and the pO₂ value in a sample:

$$pO_2(\tau) = k \times \left(\frac{\tau_0}{\tau} - 1 \right)$$

Where k and τ_0 are constants.

Calibration - pO₂ sensor

Overview of pO₂ calibrations

CAL 1 solution and ambient air are used to do a sensitivity calibration of the pO₂ sensor. A status calibration is done before every measurement to check the performance of the sensor between sensitivity calibrations.

Sensitivity

The sensitivity is defined as the percentage of the measured pO₂ on ambient air compared to the reference value:

$$S = \frac{pO_2(\text{meas})}{pO_2(\text{ref})}$$

Where $pO_2(\text{ref})$ is the pO_2 tension in ambient air saturated with water vapor:

$$pO_2(\text{ref}) = FO_2 \cdot (p(\text{amb}) - p_{H_2O})$$

where FO_2 is the pO_2 fraction in ambient air, and p_{H_2O} is the partial water vapor pressure of saturated air at 37 °C, and $p(\text{amb})$ is the barometric pressure.

Status

In connection with the sensitivity calibration done on ambient air, also the CAL 1 solution is measured to obtain a status. This status aims to check the performed calibration. This is done by a compare the measured value of the CAL 1 solution to the reference value of CAL 1, given by the smart chip:

$$pO_2(\text{status,cal}) = pO_2(\text{CAL 1, cal}) - pO_2(\text{CAL 1, ref})$$

For every measurement, the pO_2 calibration is checked by a compare of the measured value of CAL 1 solution to the value obtained on the CAL 1 solution of the last calibration (CAL 1, cal):

$$pO_2(\text{status, meas}) = pO_2(\text{CAL 1,meas}) - pO_2(\text{CAL 1, cal})$$

The CAL 1 solution is used to do a status calibration of the pO_2 sensor. The measured value of the CAL 1 solution is compared to the reference value of the CAL 1 solution that is read from the smart chip of the Solution Pack.

$$pO_2(\text{status,cal}) = pO_2(\text{CAL 1,meas}) - pO_2(\text{CAL 1, ref})$$

The status calibration of the pO_2 sensor is done before every measurement. The measured value of the CAL 1 solution is compared with the value obtained during the previous status calibration to determine the status drift:

$$pO_2(\text{status,drift}) = pO_2(\text{CAL 1,meas}) - pO_2(\text{CAL 1,prev cal}).$$

Measurement - pO_2 sensor

Calculation of pO_2 values

On blood, pO_2 is adjusted with the sensitivity value and the measured pO_2 is therefore determined as follows:

$$pO_2(\text{sens,adjusted}) = \frac{pO_2(\text{meas})}{S}$$

The measured value is applied as a second-order blood correction, to compensate for the varying buffer value of blood, as a function of pO_2 tension. A second-order correction is applied:

$$pO_2(\text{display}) = k_1 pO_2^2 + k_2 pO_2 + k_3$$

Note: Air bubbles in samples may collect in front of the pO_2 sensor and cause incorrect results. However, the analyzer will detect them and attach a message to the results.

Metabolite sensors

Construction - metabolite sensors

Construction

The cGlu and cLac sensors are three-electrode sensors which consist of an internal silver/silver chloride reference electrode, a platinum auxiliary electrode, and a platinum anode. The sensors are covered by a multi-layer membrane bound to the sensor board.

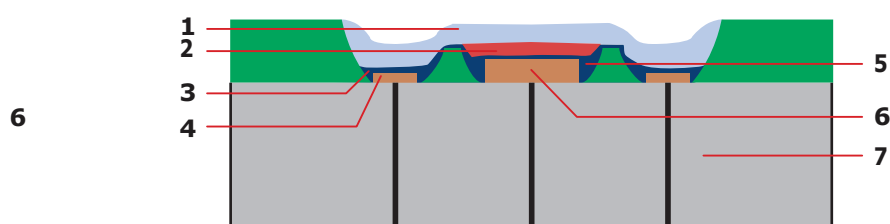

- | | |
|---|--|
| 1 Biocompatible layer – Biocompatible layer | 5 Reference – Ag/AgCl electrode |
| 2 Outer membrane – Outer membrane permeable to glucose/lactate – diffusion control | 6 Anode – Platinum electrode |
| 3 Enzyme layer – Contains glucose/lactate oxidase | 7 Cathode – Platinum electrode |
| 4 Inner membrane – Cellulose acetate | 8 Sensor base – The structural platform on which the sensor is formed |

Zero current

The zero current is a small background current measured at the electrode when no cGlu/cLac is present in a solution. As CAL 1 solutions contain no cGlu/cLac, a baseline that represents the zero current, I_0 as a function of time ($I_0 = f(t)$), is obtained from continuous measurements on CAL 1 solutions.

This I_0 baseline is obtained as follows:

- At the end of a rinse, with CAL 1 solution in the measuring chamber, the zero current of the metabolite electrodes is measured periodically.
- The previous N (N = 8) measurements on the CAL 1 solution - before a calibration or a sample measurement starts - are used to obtain a baseline that represents the time function of I_0 .
- The baseline is extrapolated throughout the whole electrode calibration or sample measurement period, and represents the zero current time function.
- The I_0 baseline is used in the determination of the sensitivity of the cGlu/cLac sensor.

Calibration - metabolite sensors

Calculation of sensitivity

The sensitivity of the cGlu and cLac sensors is calculated by measuring the current from CAL 3 solution, then subtracting the zero current as measured from CAL 1 solution. CAL 3 solution has a nominal glucose concentration of 10 mmol/L and a nominal lactate concentration of 10 mmol/L. The precise values are specific to the individual lot of the Solution Pack and are contained in the Solution Pack smart chip.

The current at the cGlu and cLac sensors with CAL 3 solution in the measuring chamber is measured at regular intervals after the chamber is filled with solution. The current, when signal stability is reached, is used to determine the sensitivity of the cGlu or cLac sensor.

The sensitivity of the cGlu or cLac sensor is calculated as follows:

$$S = \frac{I_{\text{cal3}} - I_0}{C_{\text{cal}}}$$

where I_0 is the zero current extrapolated to the time of measurement from the 8 samples taken on CAL 1 solution.

Status is defined as I_0 .

Measurement - metabolite sensors

Calculation of metabolite values

The glucose or lactate concentration in a sample is calculated from the equation shown below, where the difference between the current in the sample and the extrapolated zero current from the rinse solution is used:

$$C = \frac{I_{\text{sample}} - I_0}{S}$$

The measured value is found after this linear correction has been applied:

$$C_{\text{displayed}} = k_1 \times C + k_2$$

Note: cLac is compensated for the dependence of the ionic composition by the use of the measured electrolyte values before the linear correction is applied. If the electrolytes are not measured, default values are used.

Sensor response stability of the metabolite sensors

For CAL 1 solution, the sensor response stability is defined as the standard deviation of the last 5 calculated status calibration values.

For CAL 3 solution, the sensor response stability is defined as the standard deviation of a linear regression for the last 5 calculated status calibration values, normalized with the signal magnitude.

Measurement principle - metabolite sensors

Amperometric measurement principle

The cGlu and cLac sensors are measured according to the amperometric measurement principle, in which the magnitude of an electrical current that flows through an electrode chain is related to the concentration of a substance that is oxidized or reduced at an electrode in the chain.

Electrode chain

The electrode chain set up to measure glucose/lactate is illustrated in the diagram:

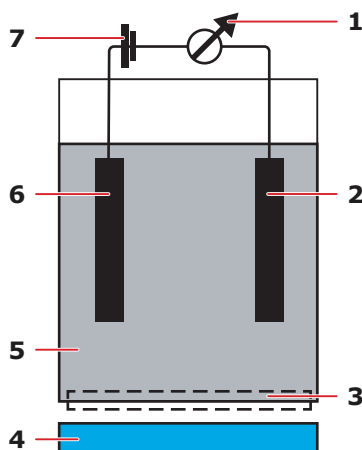

- | | |
|---|--|
| <p>1 Amperemeter – Measures the current that flows through the circuit in nanoamperes</p> <p>2 Cathode – Negative electrode where a reduction reaction occurs and electrons are consumed</p> <p>3 Membrane – Lets the appropriate molecules to pass through from the sample</p> <p>4 Sample – Contacts the membrane</p> | <p>5 Electrolyte – Provides electrical contact between the anode and cathode</p> <p>6 Anode – Positive electrode where an oxidation reaction occurs and electrons are released</p> <p>7 Applied voltage – Applies the necessary potential for the reduction or oxidation reaction under study</p> |
|---|--|

Note: Note that polarization voltage is applied between the anode and the reference electrode (not shown). The current runs through the anode and cathode chain.

Measurement process

A constant polarization voltage is applied to the electrode chain. The current through this chain is measured by an amperemeter.

Glucose or lactate molecules, in solution, are transported across the outer layer of a multilayer membrane system. The enzymes glucose oxidase or lactate oxidase, immobilized between the outer and inner layers, converts glucose/lactate according to these reactions:

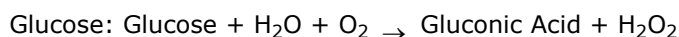

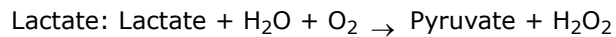

The oxygen for this reaction is supplied by the membrane system as well as by the oxidation of H_2O_2 at the platinum anode.

The H_2O_2 produced by the enzyme reaction is transported across the inner membrane to the platinum anode.

When a potential is applied to the electrode chain, the oxidation of H_2O_2 produces an electrical current proportional to the amount of H_2O_2 , which in turn is directly related to the amount of glucose/lactate.

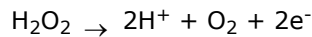

At the counter electrode a reduction process that consumes electrons will occur:

1. $\text{H}_2\text{O}_2 + 2\text{e}^- \rightarrow 2\text{OH}^-$ (This process consumes excess H_2O_2 not consumed in the reaction above)
2. $\frac{1}{2}\text{O}_2 + \text{H}_2\text{O} + 2\text{e}^- \rightarrow 2\text{OH}^-$ (This process consumes excess O_2 not consumed in the reaction above)
3. $2\text{H}_2\text{O} + 2\text{e}^- \rightarrow \text{H}_2 + 2\text{OH}^-$ (This process can also occur at the cathode)

Any of these three reactions at the cathode will serve to neutralize the protons generated in the second reaction, so the total change in acidity is caused by the gluconic acid/pyruvate only.

ctHb and derivatives

Description of the optical system

Measured parameters

The optical system of the ABL90 FLEX analyzer is designed to measure these parameters:

Parameter	Description
ctHb	Concentration of total hemoglobin
sO ₂	Oxygen saturation
FO ₂ Hb	Fraction of oxyhemoglobin
FCO ₂ Hb	Fraction of carboxyhemoglobin
FHHb	Fraction of deoxyhemoglobin
FMetHb	Fraction of methemoglobin
FHbF	Fraction of fetal hemoglobin
ctBil*	Concentration of total neonatal bilirubin (the sum of unconjugated and conjugated bilirubin) in plasma

Note: ctBil* can be measured on blood or plasma samples. Plasma samples provide the optimal measurement performance. To obtain optimal accuracy when following a patient trend in ctBil*, use the same sample type and the same analyzer.

* Bilirubin can only be measured on neonatal samples. This parameter is only available in the Neonate blood analysis 65 μ L mode.

Construction

The optical system is based on a 256-wavelength spectrophotometer with a measuring range of 467-672 nm. The spectrophotometer is connected via an optical fiber to a combined hemolyzer and measuring chamber.

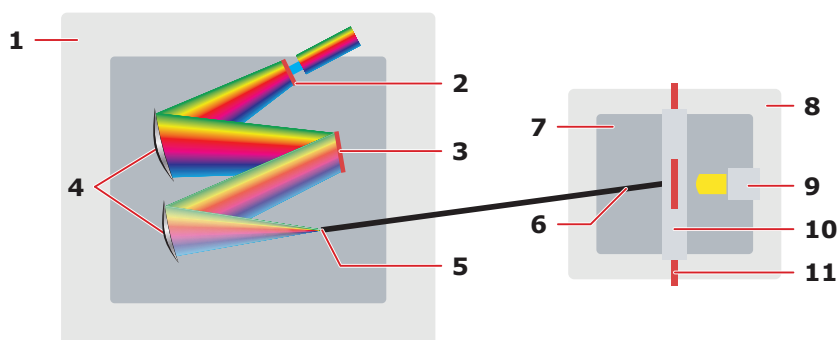

- | | |
|-------------------------------|---------------------------|
| 1 Spectrophotometer | 7 Hemolyzer |
| 2 Array of photodiodes | 8 Hemolyzing unit |
| 3 Grating | 9 LED light source |
| 4 Mirrors | 10 Cuvette |
| 5 Slit | 11 Sample |
| 6 Optical fiber cable | |

Measurement cycle

The method used in the analyzer's optical system is visible absorption spectroscopy. The measurement cycle is as follows:

1. The blood sample is transported to the cuvette in the hemolyzer unit. The temperature of the cuvette is adjusted to 37 °C.
2. A back pressure is exerted on the sample. This one atmosphere over-pressurization is maintained during the hemolyzation and measurement to remove air bubbles in the sample and to enhance the hemolyzation process.
3. The 1- μ L sample in the cuvette is ultrasonically hemolyzed at a frequency of about 30 kHz. This hemolyzation process ruptures the walls of the red blood cells and the content of the red blood cells is evenly mixed with the plasma and an optically clear solution is produced.
4. Light from a white LED is sent into the cuvette and the light is transmitted through the cuvette via an optical fiber to the spectrophotometer.
5. The light passes through a slit that points the light towards an arrangement of mirrors and a grating.
6. The grating divides the light into the colors of the rainbow and the mirror focuses the light on a photodiode array.

7. The photodiode array, which has 256 diodes or pixels, one for each wavelength, converts the monochromatic light signals to currents.
8. The currents are measured at each of the 256 diodes. The currents form the basis for the absorption spectrum for a particular sample.
9. The spectrum is sent to the analyzer, which calculates the oximetry parameter values.

Lambert-Beer's law

Absorption spectroscopy is based on Lambert-Beer's law, which states that the measured absorbance for a single compound is directly proportional to the concentration of the compound and the length of the light path through the sample [2]:

$$A_y^\lambda = \varepsilon_y^\lambda \times C_y \times l$$

Where:

A_y^λ = absorbance of compound y at wavelength λ

ε_y^λ = extinction coefficient of compound y at wavelength λ (a constant, characteristic of the compound)

C_y = concentration of compound y in sample

l = length of the light path

Absorbance

The absorbance (A) of a compound is defined as the logarithm of the ratio of the light intensity before and after transmission through the compound.

In practice it is the logarithm of the ratio of the light intensity transmitted through water to the light intensity transmitted through the compound.

$$A = \log \frac{I_0}{I}$$

Where:

I_0 = intensity of light transmitted through water (I_0 is measured as the intensity of light transmitted through CAL 3 solution)

I = intensity of light transmitted through the compound

Total absorbance

For samples that contain more than one optically active compound, the total absorbance (A_{total}) is the sum of the individual compounds' absorbance, since absorbance is an additive quantity.

For example, if a sample contains six compounds y_1, y_2, \dots, y_6 , the total absorbance measured for that sample at wavelength λ_1 is:

$$\begin{aligned} A_{total}^{\lambda_1} &= A_{y_1}^{\lambda_1} + A_{y_2}^{\lambda_1} + A_{y_3}^{\lambda_1} + A_{y_4}^{\lambda_1} + A_{y_5}^{\lambda_1} + A_{y_6}^{\lambda_1} \\ &= l \left(\varepsilon_{y_1}^{\lambda_1} C_{y_1} + \varepsilon_{y_2}^{\lambda_1} C_{y_2} + \varepsilon_{y_3}^{\lambda_1} C_{y_3} + \varepsilon_{y_4}^{\lambda_1} C_{y_4} + \varepsilon_{y_5}^{\lambda_1} C_{y_5} + \varepsilon_{y_6}^{\lambda_1} C_{y_6} \right) \end{aligned}$$

If there are Y compounds and measurements are made at n wavelengths, a general expression can be written for A_{total} at the wavelength λ_n :

$$A_{\text{total}}^{\lambda_n} = \sum_{y=1}^Y \varepsilon_y^{\lambda_n} \times c_y \times l$$

Where:

λ_n = the individual wavelengths.

Continuous spectrum

$A_{\text{total}}^{\lambda_n}$ can be depicted graphically as a function of wavelength, and if the differences between the wavelengths are small enough, a continuous spectrum is produced.

Spectrum example

The figure below shows three spectra; pure O₂Hb, pure HHb at a low concentration, a spectrum of 92% oxygenated hemoglobin that is obtained by adding the spectra of O₂Hb and HHb. The additivity of absorption and the continuity of the spectra can be seen.

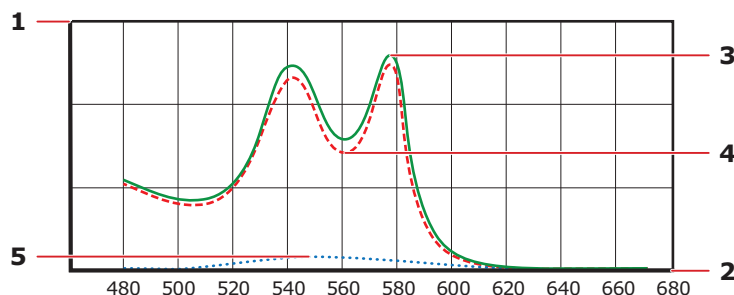

- | | | | |
|---|----------------------------------|---|---------------------------------|
| 1 | Absorption | 4 | FO ₂ Hb (9.2 mmol/L) |
| 2 | Wavelength (nm) | 5 | FHHb (0.8 mmol/L) |
| 3 | 92% FO ₂ Hb, 8 % FHHb | | |

Determining concentrations

In the measured spectrum of a sample, the absorption recorded at each wavelength contains contributions from each of the compounds in the sample. The task then is to determine the magnitude of that contribution and thereby the concentration of each compound in the sample.

The concentrations are determined as follows:

$$c_y = \sum_{n=1}^{138} K_y^{\lambda_n} A_{\text{total}}^{\lambda_n}$$

Where $K_y^{\lambda_n}$ = a constant specific to compound y at wavelength λ_n .

Matrix of constants

The constants ($K_y^{\lambda_n}$) are determined by the use of the Multivariate Data Analysis [2] where the spectra of the calibration compounds are considered together with the refer-

ence values of the calibration compounds. The essential interfering substances (intralipids and sulfhemoglobin) were also taken into account.

Calibration of the optical system

Calibration materials

The optical system is calibrated at two points by the use of these solutions:

- The S7770 ctHb Calibration Solution with a known dye concentration to determine the cuvette path length, l .
- A transparent solution from the Solution Pack in the analyzer to determine the zero point, I_0 .

Zero point

The zero point, I_0 , is the current (or intensity) measured by the photodiode array on the transparent solution in the cuvette. During this blank calibration the ctHb is calibrated to this zero point.

I_0 is measured automatically during system start up and during calibrations.

Cuvette path length

The cuvette path length (i.e. the length of the light path) is determined from Lambert-Beer's Law by measuring the absorbance of the colored dye present in the tHb Calibration Solution (S7770), which has a known equivalent hemoglobin concentration.

Beer's Law: $A = \epsilon \times C_{dye} \times l$

Where

A = absorbance

ϵ = extinction coefficient

C_{dye} = concentration of colored dye

l = length of light path

Correcting for interferences

HbF versus HbA

Fetal hemoglobin (HbF) does not have the same spectrum as adult hemoglobin (HbA) due to a slight variation in molecular structure. The presence of HbF in a sample will interfere with the result if a correction is not made.

Therefore, when hemoglobin levels are measured in samples from premature neonates and neonates aged 0-3 months, as well as from adults who suffer from e.g. thalassemia, it is important to take into account this difference [4], and to make sure that the analyzer automatically corrects for HbF.

Note: The analyzer only compensates for interference caused by the presence of HbA and HbF.

The diagram shows the transition from fetal hemoglobin to adult hemoglobin [5].

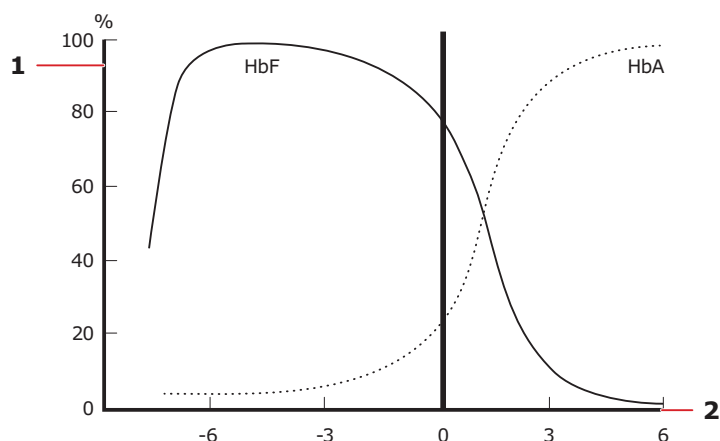

1 Hemoglobin

2 Months

This graph is only schematic and cannot be used to determine $FHbF$.

Deviation of results

If the difference between the adult and fetal types of hemoglobin is not taken into account in measurements on samples that contain HbF (e.g. from premature neonates and neonates aged 0-3 months) then a deviation in the measurement will occur.

The deviation is most important for measurements of oxygen saturation (sO_2 and FO_2Hb) and the fraction of carboxyhemoglobin (FCO_{Hb}), since inaccurate measurements of these parameters can lead to incorrect diagnostic interpretation of the results, and consequent risk of inappropriate treatment.

Detecting HbF

The presence of HbF in a sample is detected by measuring the difference between the spectra of fetal and adult oxyhemoglobin. Fetal oxyhemoglobin, cO_2HbF , is determined by the difference.

Correcting for HbF

The amount of cO_2HbF that exceeds a certain level indicates HbF interference. The analyzer automatically corrects for this interference by subtracting the difference spectrum of fetal oxyhemoglobin from the measured spectrum.

Repressing spectra

Repressing the spectra of the likely interfering substances is done in two ways depending on the substance:

- **Either** the substance is taken account of in the calculation of the matrix of constants, K . This applies to Intralipids and Sulfhemoglobin.
- **Or** the substance is detected, and the measured spectrum is corrected accordingly. This applies to HbF.

Residual spectrum

The measured spectrum is compared to a model spectrum calculated from the determined concentrations. The difference between these two spectra is called the residual

spectrum. If this residual spectrum is too high, the oximetry module parameters ctHb, sO₂, FO₂Hb, FCOHb, FMetHb, FHHb, FHbF and ctBil* will be flagged with a warning.

In addition, a warning will accompany the results if any of these conditions exist:

- ctHb < -0.1 mmol/L or ctHb > 25 mmol/L
- FHb(deriv) < -2 % or FHb(deriv) > 102 % where FHb(deriv) is defined as sO₂, FO₂Hb, FCOHb, FMetHb, FHHb
- SHb < -2 % or SHb > 10 %
- Value of turbidity < - 0.5 % or > 5 %

* Bilirubin can only be measured on neonatal samples. This parameter is only available in the Neonate blood analysis 65 µL mode.

Measurement and corrections

Calculation of the values of the oximetry parameters

The oximetry parameters are calculated as follows:

Parameter	Equation
ctHb(meas)	= cO ₂ Hb + cCOHb + cHHb + cMetHb
sO ₂	$= \frac{cO_2Hb}{ceHb}$ ceHb = cHHb + cO ₂ Hb (effective hemoglobin)
FO ₂ Hb	$= \frac{cO_2Hb}{ctHb}$
FCOHb	$= \frac{cCO_2Hb}{ctHb}$
FHHb	$= \frac{cHHb}{ctHb}$
FMetHb	$= \frac{cMetHb}{ctHb}$
FHbF	$= \frac{cHbF}{ctHb}$

Calculation of bilirubin* values

Bilirubin is calculated as follows:

$$ctBil(P) = \frac{ctBil(B)}{1 - Hct(calc)}$$

Where:

ctBil*(P)	=	concentration of total neonatal bilirubin in plasma
ctBil*(B)	=	concentration of neonatal diluted plasma bilirubin after sample hemolyzation

Hct(calc)	=	<p>calculated hematocrit (a fraction):</p> $\text{Hct(calc)} = \frac{0.0301}{\text{g/dl}} \times \text{ctHb}$ <p>For further details on Hct(calc) please refer to Interference Tests and the explanation of MCHC (Mean Corpuscular Hemoglobin Concentration) in this manual.</p>
-----------	---	--

* Bilirubin can only be measured on neonatal samples. This parameter is only available in the Neonate blood analysis 65 μL mode.

Restrictions

These parameters will not be calculated:

Parameter	Is not calculated if...
$s\text{O}_2$, FCO_2Hb , FMetHb , FHb , FO_2Hb	$\text{ctHb} < 1 \text{ mmol/L}$
$s\text{O}_2$	$\text{ceHb} = \text{cHHb} + \text{cO}_2\text{Hb} < 0.75 \text{ mmol/L}$
ctBil^*	$\text{ctHb} > 14.27 \text{ mmol/L}$

* Bilirubin can only be measured on neonatal samples. This parameter is only available in the Neonate blood analysis 65 μL mode.

To correct for the presence of HbF in a sample, these conditions are required:

Parameter or settings	Conditions
ctHb	Concentration $> 5 \text{ mmol/L}$
FCO_2Hb	Concentration $< 20 \%$
FMetHb	Concentration $< 10 \%$
HbF correction setting - "Enabled for levels $> 20 \%$ "	$\text{cO}_2\text{HbF}/\text{ctHb}$ should be more than 0.2
HbF correction setting - "Enabled for all levels"	No lower limit value for cO_2HbF is required. Even adult blood samples will be corrected for HbF. This setting may be of value when you analyze blood samples from newborns who have received adult blood transfusion. In these cases FHbF can be lower than 20% and significant deviations of oximetry parameters and bilirubin* can occur.
HbF correction setting - "Disabled"	No HbF corrections are made
HbF correction has been enabled	The message "Oxi compensated for HbF" is attached to the result
$s\text{O}_2 < 50\%$	The message "FHbF measurement not possible" is shown by the analyzer, if a HbF suppression has been activated, and the FHbF estimation from cO_2HbF is too uncertain

* Bilirubin can only be measured on neonatal samples. This parameter is only available in the Neonate blood analysis 65 μL mode.

Corrections for ctHb

The uncorrected hemoglobin concentration, ctHb(sample), measured on capillary or syringe samples is corrected as follows:

$$\text{ctHb}(\text{sample,corr}) = \frac{\text{ctHb}(\text{sample})}{F_{\text{cuv}}}$$

Where:

ctHb(sample,corr)	=	corrected ctHb
F _{cuv}	=	analyzer-dependent cuvette path length constant determined at tHb calibrations and automatically saved by the analyzer

Corrections for ctBil*

The uncorrected total bilirubin concentration, ctBil*(sample), measured on capillary or syringe samples is corrected as follows:

$$\text{ctBil}(\text{sample,corr}) = \frac{\text{ctBil}(\text{sample})}{F_{\text{cuv}}}$$

F_{cuv} is the same as for tHb.

* Bilirubin can only be measured on neonatal samples. This parameter is only available in the Neonate blood analysis 65 µL mode.

References

1. Ewing GW. Instrumental methods of chemical analysis. 5th ed. McGraw.Hill, 1985.
2. Martens H. Multivariate calibration: quantitative interpretation of non-selective chemical data: Dr. Techn. Thesis. NTH Univ. of Trondheim, 1986.
3. Krzeminski A. Why correct for fetal hemoglobin in blood oximetry measurements? Radiometer Publication Info. No. 1992-3. Copenhagen: Radiometer Medical A/S, 1992.
4. Huehns ER, Beanen GH. Developmental changes in human hemoglobins. Clin Dev Med 1971; 37: 175-203.

Analyzer specifications

Ranges of indication and reportable ranges

Parameter	Unit	Range of indication*	Reportable range
pH	pH scale	6.3-8.0	6.818-7.797
$p\text{CO}_2$	mmHg; Torr	5-250	15.4-98.3
	kPa	0.67-33.3	2.05-13.1
$p\text{O}_2^*$	mmHg; Torr	0-800	30.1-488
	kPa	0-107	4.0-65.0
ctHb	g/dL	-0.48-27.7	0.1-24.0
	g/L	-4.8-277	0.8-240
	mmol/L	-0.30-17.2	0.05-14.9
$s\text{O}_2$	%	-2-102	3.3-100.0
	Fraction	-0.02-1.02	0.033-1.000
FO_2Hb	%	-2-103	3.3-98.5
	Fraction	-0.02-1.03	0.033-0.985
FCOHb	%	-2-103	1.00-92.2
	Fraction	-0.02-1.03	0.010-0.922
FMetHb	%	-2-103	1.00-91.0
	Fraction	-0.02-1.03	0.010-0.910
FHHb	%	-2-102	2.4-98.5
	Fraction	-0.02-1.02	0.024-0.985
FHbF	%	-25-121	21-83
	Fraction	-0.25-1.21	0.21-0.83
cK^+	mmol/L; meq/L	0.5-25	2.1-10.5
cNa^+	mmol/L; meq/L	7-350	116-180
cCa^{2+}	mmol/L	0.1-9.99	0.50-2.48
	meq/L	0.4-19.98	1.00-4.96

Parameter	Unit	Range of indication*	Reportable range
cCa ²⁺	mg/dL	0.8-40.04	2.00-9.92
cCl ⁻	mmol/L; meq/L	7-350	86-151
cGlu**	mmol/L	0-60	0.5-41
	mg/dL	0-1081	9-738
cLac	mmol/L; meq/L	-0.1-31	0.4-24
	mg/dL	-1-279	4-216
ctBil***	µmol/L	-20-1000	28-648
	mg/dL	-1.2-58.5	1.6-37.9
	mg/L	-12-585	16-379

* The Range of indication is the range the analyzer is capable of measuring and includes values outside the Reportable range. The performance of the analyzer outside the Reportable range specified in the table has not been validated. Only results within the Reportable range should be reported.

** See *Related information*.

*** Bilirubin can only be measured on neonatal samples. This parameter is only available in the Neonate blood analysis 65 µL mode.

Related information

pO₂ levels - how they affect cGlu results, page 229

Measurement precision within specified ranges

The table shows the precision (number of decimals) of the parameters within the ranges shown. The ranges should be taken into consideration when external systems are interfaced to the analyzer.

Parameter symbol	Unit	Lower range		Upper range	
		Lower limit	Upper limit	Lower limit	Upper limit
pH	-	4.000	11.000		
pH(T)	-	4.000	11.000		
cH ⁺	nmol/L	-999999.0	199.9	200	9999999
cH ⁺ (T)	nmol/L	-999999.0	199.9	200	9999999
pCO ₂	mmHg	0.0	99.9	100	750
	kPa	0.00	9.99	10.0	100.0
pCO ₂ (T)	mmHg	0.0	99.9	100	750
	kPa	0.00	9.99	10.0	100.0
cHCO ₃ ⁻ (P)	mmol/L	0.0	100.0		
cBase(B)	mmol/L	-50.0	50.0		
cBase(B,ox)	mmol/L	-100.0	100.0		
cBase(Ecf)	mmol/L	-50.0	50.0		

Parameter symbol	Unit	Lower range		Upper range	
		Lower limit	Upper limit	Lower limit	Upper limit
cBase(Ecf,ox)	mmol/L	-100.0	100.0		
cHCO ₃ ⁻ (P,st)	mmol/L	0.0	150.0		
ctCO ₂ (P)	mmol/L	0.0	100.0		
	Vol %	0.0	224.1		
	mL/dL	0.0	224.1		
ctCO ₂ (B)	mmol/L	0.0	100.0		
	Vol %	0.0	224.1		
	mL/dL	0.0	224.1		
pH(st)	-	4.000	11.000		
VCO ₂ /V(dry air)	%	-10.0	110.0		
	fraction	-0.100	1.100		
Hct	%	-10.0	110.0		
	fraction	-0.100	1.100		
pO ₂	mmHg	0.0	99.9	100	2500
	kPa	0.00	9.99	10.0	99.9
				100	300
pO ₂ (T)	mmHg	0.0	99.9	100	750
	kPa	0.00	9.99	10.0	99.9
				100	300
pO ₂ (A)	mmHg	0.0	750.1		
	kPa	0.00	100.00		
pO ₂ (A,T)	mmHg	0.0	750.1		
	kPa	0.00	100.00		
p50	mmHg	0.00	750.06		
	kPa	0.00	100.00		
p50(T)	mmHg	0.00	750.06		
	kPa	0.00	100.00		
p50(st)	mmHg	0.00	750.06		
	kPa	0.00	100.00		
pO ₂ (A-a)	mmHg	0.0	750.1		
	kPa	0.00	100.00		
pO ₂ (A-a,T)	mmHg	0.0	750.1		

Parameter symbol	Unit	Lower range		Upper range	
		Lower limit	Upper limit	Lower limit	Upper limit
$pO_2(A-a,T)$	kPa	0.00	100.00		
$pO_2(a/A)$	%	0.0	10000.0		
	fraction	0.000	100.000		
$pO_2(a/A,T)$	%	0.0	10000.0		
	fraction	0.000	100.000		
$pO_2(a)/FO_2(I)$	mmHg	0.0	99.9	100	7501
	kPa	0.00	9.99	10.0	1000.0
$pO_2(a,T)/FO_2(I)$	mmHg	0.0	99.9	100	7501
	kPa	0.00	9.99	10.0	1000.0
$pO_2(x)$	mmHg	0.0	750.1		
	kPa	0.00	100.00		
$pO_2(x,T)$	mmHg	0.0	750.1		
	kPa	0.00	100.00		
$ctO_2(B)$	mmol/L	0.0	100.0		
	Vol %	0.0	224.1		
	mL/dL	0.0	224.1		
$ctO_2(a-\bar{v})$	mmol/L	0.0	100.0		
	Vol %	0.0	224.1		
	mL/dL	0.0	224.1		
BO_2	mmol/L	0.0	100.0		
	Vol %	0.0	224.1		
	mL/dL	0.0	224.1		
$ctO_2(x)$	mmol/L	0.0	100.0		
	Vol %	0.0	224.1		
	mL/dL	0.0	224.1		
$\dot{D}O_2$	mL/min	0	22414		
	mmol/min	0.0	1000.0		
\dot{Q}_t	L/min	0.0	100.0		
$\dot{V}O_2$	mL/min	0	22414		
	mmol/min	0.0	1000.0		
$FShunt$	%	-10.0	110.0		
	fraction	-0.100	1.100		

Parameter symbol	Unit	Lower range		Upper range	
		Lower limit	Upper limit	Lower limit	Upper limit
FShunt(T)	%	-10.0	110.0		
	fraction	-0.100	1.100		
RI	%	-10	999900		
	fraction	-0.10	9999.00		
RI(T)	%	-10	999900		
	fraction	-0.10	9999.00		
Q _x	fraction	-0.10	10.0		
V(B)	L	0.0	20.0		
Anion Gap, K ⁺	mmol/L	-500.0	500.0		
	meq/L	-500.0	500.0		
Anion Gap	mmol/L	-500.0	500.0		
	meq/L	-500.0	500.0		
cCa ²⁺ (7.4)	mmol/L	0.00	50.00		
	meq/L	0.00	100.00		
	mg/dL	0.00	200.40		
mOsm	mmol/kg	-0.7	3150.0		
Pressure (Baro.)	mmHg	98	1500		
	kPa	13.0	200.0		
ctHb	g/dL	-0.81	0.99	1.0	80.6
	g/L	-8.1	9.9	10	806
	mmol/L	-0.50	0.99	1.0	50.0
sO ₂	%	-1000.0	1000.0		
	fraction	-10.000	10.000		
FO ₂ Hb	%	-1000.0	1000.0		
	fraction	-10.000	10.000		
FCO ₂ Hb	%	-1000.0	1000.0		
	fraction	-10.000	10.000		
FMetHb	%	-1000.0	1000.0		
	fraction	-10.000	10.000		
FHHb	%	-1000.0	1000.0		
	fraction	-10.000	10.000		
FHbF	%	-100	200		

Parameter symbol	Unit	Lower range		Upper range	
		Lower limit	Upper limit	Lower limit	Upper limit
FHbF	fraction	-1.00	2.00		
cK ⁺	mmol/L	0.0	100.0		
	meq/L	0.0	100.0		
cNa ⁺	mmol/L	0	1500		
	meq/L	0	1500		
cCl ⁻	mmol/L	0	1000		
	meq/L	0	1000		
cCa ²⁺	mmol/L	0.00	50.00		
	meq/L	0.00	100.00		
	mg/dL	0.00	200.40		
cGlu	mmol/L	-1.0	24.9	25	150
	mg/dL	-18	2702		
cLac	mmol/L	-1.0	14.9	15	100
	meq/L	-1.0	14.9	15	100
	mg/dL	-9	901		

Product specifications

Specification	Value
Height	17.7 inches with the screen in a vertical position
Width	9.8 inches
Depth	11.4 inches
Weight	24.4 lbs
Noise levels	In front of the analyzer, when no activities are done: >27 dB. During automatic activities: >36 dB. During measurements and when data is printed: >55 dB.
Volume of sample necessary for aspiration	65 µL
Measuring time	35 seconds from the time the sample is aspirated until the results are shown
Measurement cycle time	60 seconds from the time the sample is aspirated until the analyzer is ready to analyze the next sample. The time may be different during Start Up .
Number of samples per hour	≥44 samples per hour. During Start up : ≥15 samples per hour.

Specification	Value	
Data storage capacity	Patient profiles log	Maximum 2000 patient profiles. Note: This number can be increased. Contact your local Radiometer service representative to request this option.
	Patient results log	Maximum 2000 results
	Activity log	Maximum 5000 activities
	Calibration log	Maximum 1000 results
	Quality control log	Maximum 2000 results
	Replacements log	This log is part of the Activity log
	Archived data logs	500 results from each log and 2000 activities from the Activity log
	System messages	This log is part of the Activity log
External serial port	1 × RS-232 (9-pin) connector. Baud rate: 1200, 2400, 4800, 9600, 14400, 19200, 38400.	
USB ports	3 (1 at the top and 2 in the back of the analyzer). Note: Only the USB port at the top of the analyzer can be used for the WIFI Adapter.	
Ethernet	1 × RJ45 connector, 100Base-Tx Fast Ethernet	
Keyboard/mouse port	PS/2	
External VGA screen port	Connector for VGA screen (disabled in BIOS setting)	
External communication protocols	High-level protocols: <ul style="list-style-type: none"> • ASTM • ASTM6xx • HL7 ver. 2.2 • HL7 ver. 2.5 • POCTDML1A 	
	Low-level protocols: <ul style="list-style-type: none"> • Serial • Serial(Raw) • Network(TCP/IP) • Network(TCP/IP)(RAW) • Network(TCP/IP)(ASTM) 	
Display	<ul style="list-style-type: none"> • 8" TFT-LCD, resolution 800 x 600 VGA • Resistive touch screen 	
Built-in printer	Thermal printer	
Built-in barcode reader (under the screen)	<ul style="list-style-type: none"> • Reading distance: 0-70 mm • Bar code width: ≥127 μm • Number of characters: <62 • Accepted codes: Code 128, Code 39, Code 93, Interleaved 2 of 5, Codabar 	

Specification	Value	
Laser specifications	Contains 1 laser that is in compliance with international standard (IEC 60825-1 Safety of laser products) and US requirements (21 CFR 1040.10 - LASER PRODUCTS).	
		
Thermostat	Solid state, 37.0 ±0.15 °C (Oxi: ±0.3 °C)	
Battery pack	Operation time:	Approximately 45 minutes including 10 measurements
	Charge time:	Approximately 90 minutes to fully charge a flat battery
	Voltage:	24 V
	Power consumption:	49 W/hour
Fuses	Main fuse has two protective fuses: 5 x 20 mm, 2.5A HRC (F) 250 VAC	
WiFi	Supported connector	Belkin Surf N150 Micro WLAN USB Adapter, (code number F7D1102)
	Data transfer rate	Up to 150 Mbit/s
	Data link protocols/standards	<ul style="list-style-type: none"> • IEEE 802.11b • IEEE 802.11g • IEEE 802.11n
	Supported authentication	<ul style="list-style-type: none"> • Open • WPA/WPA2
	Supported encryption settings	<ul style="list-style-type: none"> • None/WEP • TKIP/AES
	Contact your local Radiometer representative to request this option.	
Operating temperature	15 °C to 32 °C	

Environmental specifications

Specification	Value	
Location	Intended for indoor use	
Maximum altitude	3000 m	
Ambient temperature	15-32 °C	
Relative humidity	20-80 %	
Barometric pressure	At 15-30 °C:	525-800 mmHg
		70.0-106.7 kPa
		0.700-1.067 bar

Specification	Value	
Barometric pressure	At 15-30 °C:	525-800 Torr
	At 30-32 °C	600-800 mmHg
		80.0-106.7 kPa
		0.800-1.067 bar
		600-800 Torr
Mains power supply	<p>Rated voltage: 100-240 V ±10 %; 50/60 Hz.</p> <p>Average power consumption: <60 W</p> <p>Maximum power consumption: 90 W (during Start Up <106 VA for less than a second)</p> <p>Maximum voltage fluctuations: ±10 %</p> <p>Class 1 power supply</p>	
Pollution degree	2 (occasional/temporary conductivity caused by condensation)	
Heat dissipation	<60 W	
Start Up	<p>Without the metabolite sensors: Up to 2 hours.</p> <p>With the metabolite sensors: Up to 4 hours.</p> <p>Start up is the period of time from when the Sensor Cassette was installed and 3 levels of automatic QC are done. It includes the conditioning of the Sensor Cassette, calibration and QC cycles.</p>	
Ventilation	The analyzer must be in a well-ventilated room to ensure proper functioning.	
EMC immunity	The equipment complies with the immunity requirements in EN 61326-2-6: Electrical equipment for measurement, control and laboratory use - EMC requirements - Part 2-6 Particular requirements - In vitro diagnostic (IVD) medical equipment	
EMC emission	The equipment complies with the emission requirements for Class A equipment in EN 61326-1: Electrical equipment for measurement, control and laboratory use - EMC requirements part 1: General requirements.	
Space requirement	<p>Sufficient space in front and on the sides of the analyzer to prevent it overheating.</p> <p>Do not put the analyzer in an enclosure.</p> <p>Easy access to the mains power switch that connects the analyzer to the mains.</p>	
Storage temperature	-20 °C to 60 °C	

Power-supply cords

Country	Power-supply cord specifications
For USA (125 VAC)	<p>UL listed and KAM cord, min. type SV, min. 18 AWG, 3 conductors. Rated min. 60 C.</p> <p>Provided with a molded grounding-type (NEMA 5-15P) attachment plug rated 125 VAC, min. 2.5 A.</p> <p>Opposite end terminates in molded IEC 320 style connector rated 125 VAC, min. 2.5 A.</p>

The power-supply cord and plug of the analyzer must comply with national regulations. If the regulations are not complied with, the equipment may be damaged.

External devices connected to the analyzer must be in compliance with the standard UL 60905 for US and IEC 60950 for Europe. If you do not do this, the equipment may be damaged.

Analytical sensitivity – ctBil*

To establish reportable ranges for neonatal ctBil*, limit of quantitation (LoQ) was determined.

Parameter	Limit of blank (LoB)	Limit of detection (LoD)	Limit of quantitation (LoQ)
ctBil* (mg/dL)	1.1	1.6	1.6

*Bilirubin can only be measured on neonatal samples. This parameter is only available in the Neonate blood analysis 65 μ L mode.

The study followed the guideline CLSI EP17-A2. Evaluation of Detection Capability for Clinical Laboratory Measurement Procedures. Approved Guideline – 2nd Edition. CLSI document EP17-A2. Wayne, PA: Clinical and Laboratory Standards Institute; 2012.

Consumables specifications

Solution Pack

Intended use of the Solution Pack

For calibration of sensors, quality control, evaluation of accuracy and precision, rinse of measuring system and collection of waste from the analyzer.

Solution Pack specifications

Specification	Details
Number of activities	Depends on the Solution Pack version. An activity can be a patient or QC measurement, a calibration or a rinse.
Storage temperature	2-25 °C

Specification	Details
Storage humidity	20-80 %
Shelf life	Stable until the expiration date printed on the Solution Pack label
On-board stability	30 days
Expiration date	See the date printed on the Solution Pack label
Contents	<ul style="list-style-type: none"> • 3 pouches with quality control material • 3 pouches with calibration material • 1 pouch with gas mixture • 2 pouches to hold waste
Chemical composition	Reactive ingredients: See the table below Other ingredients: Biological buffers, salts, enzyme, heparin, surfactant, preservative
Certificates of traceability	Contact your local Radiometer representative
Material safety data sheet (MSDS)	Contact your local Radiometer representative

Approximate levels of measurands in the solution pack										
Solution type	pH	pCO ₂ mmHg	pO ₂ mmHg	*cNa ⁺	*cK ⁺	*cCl ⁻	*cCa ²⁺	*cGlu	*cLac	*ctHb
S9030	7.2	30	180	140	4	105	0.8	0	0	0
S9040	6.8	67	N/A	118	7	95	1.65	15	8	8
S9050	7.5	20	20	175	1.8	125	0.3	7	4	12
S1920	7.30	35	180	150	4	95	0.5	0	0	N/A
S1930	6.8	N/A	N/A	70	10	50	2.3	N/A	N/A	N/A
S1940	N/A	80	N/A	N/A	N/A	N/A	N/A	10	10	0

* Measured in mmol/L

** Bilirubin can only be measured on neonatal samples. This parameter is only available in the Neonate blood analysis 65 µL mode.

Volume of solutions in the Solution Pack		
Solution name	Solution type	Volume (mL)
QC 1	S9030	200
QC 2	S9040	100
QC 3	S9050	100
CAL 1	S1920	200
CAL 2	S1930	100
CAL 3	S1940	100

Chemical composition of the gas mixture in the Solution Pack			
Volume (mL)	Reactive ingredients		
	O ₂ %	CO ₂ %	N ₂
150 (at sea level)	42.07	5.61	52.32

Sensor Cassette

Intended use of the Sensor Cassette















For the measurement of the parameters shown on the label of the box that contains the Sensor Cassette Pack.















Sensor Cassette specifications

Specification	Details
Number of tests	Depends on the Sensor Cassette version
Storage temperature	2-8 °C
Storage humidity	20-80 %
Shelf life	When kept in its sealed container, the Sensor Cassette is stable until the expiration date printed on the label of the pack
On-board stability	30 days
Expiration date	See the date printed on the label of the pack
Contents	One Sensor Cassette in a sealed container

Explanation of graphical symbols/icons

These are the symbols and icons you may find on the analyzer and the consumable products used with it.

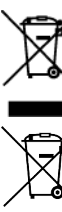
Symbol/icon	Explanation
	Syringe position
	Capillary position
	Sample mixer
	Do not open the inlet when this symbol is shown on the screen
	Keep dry
	Do not use if package is damaged
	Do not re-use
	Use by
	Contains sufficient for <n> tests
	Temperature limit
	Lot no.
	Catalog no. (product code)
	Consult instructions for use
	Manufacturer
	<i>in vitro</i> diagnostic medical device

Symbol/icon	Explanation
	Biohazard
	Keyboard
	CE marking of conformity
	COM gate (scanner/barcode reader)
	VGA (monitor)
	Mouse
	Network
	Off
	On
	UL certification
	USB
	Warning or caution
	<p>This symbol indicates that Radiometer Medical ApS and its distributors within the European Union (EU) and associated states have taken the necessary steps to comply with the "DIRECTIVE 2012/19/EU OF THE EUROPEAN PARLIAMENT AND OF THE COUNCIL of 4 July 2012 on waste of electrical and electronic equipment (WEEE)".</p> <p>Equipment marked with this symbol must not be disposed of as household waste but as electronic waste in accordance with local legislation.</p> <p>Please note that equipment contaminated with potentially infectious substances, such as body fluids, must be decontaminated before recycling. If this is not possible, the equipment must be disposed of as biohazardous material.</p> <p>Contact your local Radiometer representative for instructions.</p>
	Marks compliance with SJ/T 11363-2006 (China RoHS). The number in the symbol shows the environmentally friendly use period in years.
	Marks compliance with SJ/T 11363-2006 (China RoHS). The product contains no restricted substances above the prescribed thresholds.

Solution Packs - code numbers

Item	Volume	Code number (REF)
ABL90 FLEX solution pack	680 activities	944-157 944-197 (Germany only)
ABL90 FLEX solution pack	980 activities	944-457 944-497 (Germany only)

Sensor Cassettes - code numbers

Sensor Cassettes are available in different versions.

Abbreviations identify the parameters that each Sensor Cassette can measure.

- BG = pH, pCO_2 , pO_2
- LYT = cCa^{2+} , cK^+ , cNa^+ , cCl^-
- MET = $cGlu$, $cLac$, $ctBil^*$
- OXI = $ctHb$, sO_2 , FO_2Hb , $FMetHb$, $FCOHb$, $FHHb$, $FHbF$

For USA		Code numbers (REF) for Sensor Cassette versions	
Number of tests	On-board stability	SC90 BG, LYT, OXI + QC	SC90 BG, LYT, MET, OXI + QC
100	30 days	N/A	946-010
300	30 days	N/A	946-005
600	30 days	946-013	946-008
900	30 days	N/A	946-009
1200	30 days	N/A	946-060

*Bilirubin can only be measured on neonatal samples. This parameter is only available in the Neonate blood analysis 65 μ L mode.

Spare parts and accessories - code numbers

Product	Code number (REF)
Printer paper (8 rolls)	984-070
Clot Catcher for the ABL90 FLEX analyzer	906-026

Product	Code number (REF)
ABL90 FLEX Inlet Clip	925-047
ctHb Calibration Solution S7770	944-021
Inlet Probe	924-455
Inlet Gasket with Holder	924-816
Inlet Connector Gasket	834-662
Inlet Module	903-139
ABL90 FLEX Flush Device	905-918
ABL90 FLEX sBOX (spare parts and/or accessories for the inlet). Contact your Radiometer representative for details.	905-917
Hypochlorite Solution S5362	943-906
ABL90 FLEX Roller Stand Kit (trolley for the analyzer)	905-907
ABL90 FLEX Demo Bag (bag to transport the analyzer)	985-267
Tubing for valve	841-797

Quality control products - code numbers

QUALICHECK5+ Solutions	Code number (REF)
S7730 Level 1 (marked with a red color code)	944-017
S7740 Level 2 (marked with a yellow color code)	944-018
S7750 Level 3 (marked with a blue color code)	944-019
S7760 Level 4 (marked with a green color code)	944-020

Range+ QUALICHECK Solutions (for calibration verification use)	Code number (REF)
S7930 Level 1	944-151
S7940 Level 2	944-152
S7950 Level 3	944-153

Other QC products	Code number (REF)
Ampoule Opener	920-712
QUALICHECK Adapter	924-646
QUALICHECK+ Tray	887-860

Recommended Radiometer sampling devices - code numbers

Arterial syringe packs (100 syringes/pack)	Needle gauge and length	Volume	Code number (REF)
PICO50, 2 mL aspirator	N/A	0.5-2.0 mL	956-552
PICO70 without a needle	N/A	0.3-1.5 mL	956-518
PICO70 without a needle and a needle cube	N/A	0.3-1.5 mL	956-519
PICO70	22G × 1"	0.3-1.5 mL	956-522
PICO70	22G × 1 1/4"	0.3-1.5 mL	956-525
PICO70	23G × 5/8"	0.3-1.5 mL	956-529
PICO70	23G × 1"	0.3-1.5 mL	956-533
PICO70	23G × 1 1/4"	0.3-1.5 mL	956-534
PICO70 without a needle cube	23G × 5/8"	0.3-1.5 mL	956-546
PICO70	25G × 5/8"	0.3-1.5 mL	956-547
PICO70 without a needle cube	22G × 1"	0.3-1.5 mL	956-563
safePICO70 with a needle shield device	22G × 1 1/4"	0.3-1.5 mL	956-608
safePICO70 with a needle shield device	23G × 5/8"	0.3-1.5 mL	956-609
safePICO70 with a needle shield device	23G × 1"	0.3-1.5 mL	956-624

safePICO syringe packs (100 syringes/pack)	Volume	Dimensions	Code number (REF)
safePICO Self-fill with a safeTIPCAP, but without a needle	0.7-1.5 mL	N/A	956-610
safePICO Self-fill with a safeTIPCAP and a needle cube, but without a needle shield device	0.7-1.5 mL	23G × 5/8"	956-612
safePICO Self-fill with a safeTIPCAP and a needle cube, but without a needle shield device	0.7-1.5 mL	22G × 1"	956-613
safePICO Self-fill with a safeTIPCAP and a needle shield device	0.7-1.5 mL	22G × 1 1/4"	956-614
safePICO Self-fill with a safeTIPCAP and a needle shield device	0.7-1.5 mL	23G × 5/8"	956-615
safePICO Self-fill with a safeTIPCAP and a needle shield device	0.7-1.5 mL	23G × 1"	956-616
safePICO Self-fill with a safeTIPCAP and a needle shield device	0.7-1.5 mL	22G × 1"	956-620
safePICO aspirator	0.7-1.7 mL	N/A	956-622

Capillary tubes, glass	Description	Volume	Number of vials	Capillary tubes/vial	Code number (REF)
D957G-70-100×5 CLINITUBES	Capillary tubes with balanced heparin, mixing wires and end caps	100 µL	5	75	942-878
D956G-70-100×1 CLINITUBES	Capillary tubes with balanced heparin, mixing wires and end caps	100 µL	1	75	905-663

Capillary tubes, plastic	Description	Volume	Number of vials	Capillary tubes/vial	Code number (REF)
D957P-70-70×1 <i>safe</i> CLINITUBES	Capillary tubes with balanced heparin, mixing wires and end caps	70 µL	1	250	942-898

Power-supply cords - code numbers

Country	Mains voltage	Code number (REF)
USA and Japan	120 V	615-403
UK	230 V	615-312
Italy	230 V	615-313
Danmark	230 V	615-314
Israel	230 V	615-315
Switzerland	230 V	615-316
Australia and New Zealand	230 V	615-317
South Africa and India	230 V	615-318
All other countries	230 V	615-303

Patents and trademarks

Patents

Radiometer products may be covered by one or more patents and patent applications. See <http://www.radiometer.com/en/legal/patents>.

Trademarks

Radiometer, the Radiometer logo, ABL, AQT, TCM, RADIANCE, AQUIRE, PICO, CLINITUBES and QUALICHECK are trademarks of or used under license by Radiometer Medical ApS.

Legal notices

System performance

The procedures described in this manual must be observed in order to ensure proper system performance, and to avoid hazards.

Radiometer cannot provide or verify system performance characteristics if the system is not installed, used and maintained in accordance with Radiometer procedures or if accessories not meeting the specifications provided by Radiometer are used.

Radiometer warrants that the data media on which the software included in the system is furnished is free from defects in material and workmanship under normal use for three (3) months from the date of delivery as evidenced by a copy of invoice or receipt.

Third-party software and trademarks

The ABL90 FLEX analyzer comprises the Microsoft® Windows® Embedded and Sybase® SQL Anywhere® software.

By using the system, you accept the terms of the Software License Agreement(s) of the provider(s) of the above software as shown in the End User License Agreement(s) included in this manual. If you cannot accept the terms of the Software License Agreement(s), you should not use the system, but immediately contact your provider for a return of the system and a refund of the purchase price.

Microsoft® and Windows® are trademarks of Microsoft Corporation.

Sybase® SQL Anywhere® software is a trademark of Sybase Incorporated.

Warranties and disclaimer

Radiometer makes no warranties, express or implied, other than expressly stated.

Any warranties expressly stated in this document are conditional upon the system being installed, used and maintained in accordance with Radiometer procedures, including that only accessories meeting the specifications provided by Radiometer are used.

Radiometer disclaims any liability for system performance if the system is not installed, used and maintained in accordance with Radiometer procedures or if accessories not meeting the specifications provided by Radiometer are used.

Further, Radiometer disclaims any liability for loss of data and direct, consequential or other damages, including loss of profit or loss of business, whether such claim for damages is based upon contract, negligence or tort (including strict liability), and even if Radiometer has knowledge of the possibility of the potential damage or loss.

Confidentiality

The contents of this document shall not be reproduced or communicated to any third party without the prior written consent of Radiometer.

Changes

This document is subject to change without notice.

While every effort is made to ensure the correctness of the information provided in this document as changed from time to time, Radiometer disclaims any liability for errors and omissions.

End-user license agreement with Microsoft

You have acquired a device (ABL90 FLEX analyzer) that includes software licensed by Radiometer Medical ApS from Microsoft Licensing Inc. or its affiliates (MS). Those installed software products of MS origin, as well as associated media, printed materials, and online or electronic documentation (SOFTWARE) are protected by international intellectual property laws and treaties. The SOFTWARE is licensed, not sold. All rights reserved.

- IF YOU DO NOT AGREE TO THIS END-USER LICENSE AGREEMENT (EULA), DO NOT USE THE DEVICE OR COPY THE SOFTWARE. INSTEAD, PROMPTLY CONTACT Radiometer Medical ApS FOR INSTRUCTIONS ON RETURN OF THE UNUSED DEVICE(S) FOR A REFUND. ANY USE OF THE SOFTWARE, INCLUDING BUT NOT LIMITED TO USE ON THE DEVICE, WILL CONSTITUTE YOUR AGREEMENT TO THIS EULA (OR RATIFICATION OF ANY PREVIOUS CONSENT).
- GRANT OF SOFTWARE LICENSE. This EULA grants you the following license:
- You may use the SOFTWARE only on the DEVICE.
- NOT FAULT TOLERANT. THE SOFTWARE IS NOT FAULT TOLERANT. Radiometer Medical ApS HAS INDEPENDENTLY DETERMINED HOW TO USE THE SOFTWARE IN THE DEVICE, AND MS HAS RELIED UPON Radiometer Medical ApS TO CONDUCT SUFFICIENT TESTING TO DETERMINE THAT THE SOFTWARE IS SUITABLE FOR SUCH USE.
- NO WARRANTIES FOR THE SOFTWARE. THE SOFTWARE is provided *AS IS* and with all faults. THE ENTIRE RISK AS TO SATISFACTORY QUALITY, PERFORMANCE, ACCURACY AND EFFORT (INCLUDING LACK OF NEGLIGENCE) IS WITH YOU. ALSO, THERE IS NO WARRANTY AGAINST INTERFERENCE WITH YOUR ENJOYMENT OF THE SOFTWARE OR AGAINST INFRINGEMENT. IF YOU HAVE RECEIVED ANY WARRANTIES REGARDING THE DEVICE OR THE SOFTWARE, THOSE WARRANTIES DO NOT ORIGINATE FROM, AND ARE NOT BINDING ON, MS.
- Note on Java Support. The SOFTWARE may contain support for programs written in Java. Java technology is not fault tolerant and is not designed, manufactured or intended for use or resale as online control equipment in hazardous environments requiring fail-safe performance, such as in the operation of nuclear facilities, aircraft

navigation or communication systems, air traffic control, direct life-support machines, or weapons systems, in which the failure of Java technology could lead directly to death, personal injury, or severe physical or environmental damage. Sun Microsystems, Inc. has contractually obligated MS to make this disclaimer.

- **No Liability for Certain Damages.** EXCEPT AS PROHIBITED BY LAW, MS SHALL HAVE NO LIABILITY FOR ANY INDIRECT, SPECIAL, CONSEQUENTIAL OR INCIDENTAL DAMAGES ARISING FROM OR IN CONNECTION WITH THE USE OR PERFORMANCE OF THE SOFTWARE. THIS LIMITATION SHALL APPLY EVEN IF ANY REMEDY FAILS OF ITS ESSENTIAL PURPOSE. IN NO EVENT SHALL MS BE LIABLE FOR ANY AMOUNT IN EXCESS OF U.S. TWO HUNDRED AND FIFTY DOLLARS (USD 250.00).
- **Limitations on Reverse Engineering, Decompilation and Disassembly.** You may not reverse engineer, decompile or disassemble the SOFTWARE, except and only to the extent that such activity is expressly permitted by applicable law notwithstanding this limitation.
- **SOFTWARE TRANSFER ALLOWED BUT WITH RESTRICTIONS.** You may permanently transfer rights under this EULA only as part of a permanent sale or transfer of the Device, and only if the recipient agrees to this EULA. If the SOFTWARE is an upgrade, any transfer must also include all prior versions of the SOFTWARE.
- **EXPORT RESTRICTIONS.** You acknowledge that the SOFTWARE is of U.S. origin. You are to comply with all applicable international and national laws that apply to the SOFTWARE, including the U.S. Export Administration Regulations, as well as end-user, end-use and country destination restrictions issued by U.S. and other governments. For additional information on exporting the SOFTWARE, see <http://www.microsoft.com/exporting/>.

Index

A

- access profiles
 - edit access to menus..... 144
 - edit button shortcuts..... 144
 - acid-base chart
 - automatic printing.....168
 - acoustic signals
 - mute..... 152
 - set..... 152
 - activity log
 - about..... 134
 - add message..... 134
 - filter activities..... 134
 - see activities..... 134
 - troubleshoot messages..... 134
 - activity vs. concentration.....342
 - age groups
 - set limits..... 160
 - alarm sound settings for events
 - default settings.....207
 - alternative presentaion
 - pH/blood gas.....259
 - alternative presentation
 - electrolytes..... 259
 - metabolites..... 261
 - oximetry parameters..... 264
 - ampoule-based QC measurements
 - do..... 71
 - get good.....68
 - set up mode.....156
 - solutions for.....68
 - status..... 72
 - ampoule-based QC results
 - find.....73
 - messages..... 73
 - symbols..... 73
 - analysis modes
 - capillary..... 157
 - syringe..... 153
 - analysis setup
 - default settings.....207
 - analyzer
 - dispose..... 58
 - flush..... 95
 - front view.....5
 - installation number..... 135
 - lock.....149
 - move with charged battery.....140
 - move without battery..... 140
 - recycle..... 58
 - serial number..... 135
 - unlock..... 149
 - analyzer exterior
 - clean.....56
 - disinfect..... 57
 - analyzer messages
 - troubleshoot..... 98
 - analyzer overview
 - side and back view..... 6
 - analyzer status
 - access..... 8
 - screen..... 9
 - traffic light colors..... 9
 - analyzer-specific control ranges
 - ensure width of.....192
 - how to establish..... 191
 - stage 1..... 192
 - stage 2..... 192
 - stage 3..... 192
 - anonymous use
 - set up..... 145
 - anticoagulants
 - recommended and others..... 17
 - AQM
 - automatic QC management.....63
 - archived data logs
 - create space by moving..... 203
 - export..... 203
 - archives
 - import..... 203
 - audit trail..... 31
 - automatic archiving
 - default settings.....214
 - set up..... 202
 - automatic backup
 - default setting..... 214
 - automatic data request
 - set up..... 199
 - automatic data transmission
 - set up..... 199
 - automatic printing
 - default settings.....214
 - set up..... 200
 - automatic quality management
 - overview..... 64
- ### B
- back button
 - function.....13
 - backup
 - destinations..... 204

manual.....	204	trends.....	91
schedule automatic.....	204	understanding.....	90
barcode		calibration schedule	
scan.....	12	default settings.....	211
barcode reader		calibration solutions.....	344
connect.....	61	calibration verification	
barcodes		about.....	74
scan data from.....	151	frequency.....	74
barometric pressure		set up mode.....	156
set.....	153	using temperature corrected results.....	79
battery		calibration-verification ampoule	
installation.....	57	prepare for use.....	75
service of.....	57	calibration-verification measurement	
to charge.....	57	do.....	76
battery power.....	11	find result.....	77
bias.....	219	symbols on results.....	78
bilirubin results		calibration-verification results	
calculation.....	367	temperature correct Range+ QUALICHECK	
built-in QC measurement		measurements.....	78
status.....	66	calibrations	
built-in QC measurements		automatic and manual.....	85
about.....	65	corrective actions for scheduled.....	177
frequency.....	65, 182	identification in Calibration log screen.....	89
request unscheduled.....	66	identification in screens.....	85
built-in QC results		capillary modes	
find.....	66	edit.....	157
see messages.....	67	select a specific report layout.....	156
symbols.....	66	cautions	
troubleshoot messages.....	67	definition.....	3
		general.....	17
C		cCa2+	
calculated.....	314	performance test results.....	226
calibration		traceability.....	308
definition.....	344	cCl-	
edit schedule.....	175	performance test results.....	226
find results.....	89	traceability.....	308
frequency.....	85, 344	centralized user management	
frequency (details).....	175	set up.....	147
request an unscheduled from Analyzer		cGlu	
status screen.....	87	performance test results.....	227
request an unscheduled from menu.....	87	traceability.....	309
status.....	86	cGlu results	
symbols that show the status.....	86	effect of pO2 values.....	229
calibration equation		check buttons	
about.....	345	deselect.....	13
derivation.....	345	select.....	13
calibration frequency		cK+	
after sensor cassette replacement.....	40	performance test results.....	225
calibration log		traceability.....	308
status.....	91	cLac	
calibration results		performance test results.....	229
filter data.....	90	traceability.....	309
messages on.....	90	cleaning	
		analyzer exterior.....	56
		touch screen.....	56

- when is it necessary?..... 52
- close button
 - function.....13
- cNa+
 - performance test results..... 225
 - traceability.....308
- coefficient of variation (CV %)...220
- communication setup
 - default settings.....212
- concentration vs. activity.....342
- confidence intervals..... 220
- consumables
 - order..... 35
 - replacement intervals..... 35
 - see an overview..... 7
 - see details.....7
- control ranges
 - about analyzer-specific..... 191
 - change to analyzer-specific control ranges.....192
- converting to other units..... 334
- corrective actions
 - for errors in built-in QC.....185
 - for errors in QC results..... 184
 - for overdue calibrations..... 177
 - for overdue scheduled QC measurements..... 185
 - for pending operator activities..... 196
 - system messages.....150
- critical limit notification..... 33
- critical limits
 - about..... 160
 - set up..... 160
- ctBil
 - performance test results..... 235
 - sensitivity for MCHC variations.....257
- ctHb
 - performance test results..... 230
 - traceability.....309

D

- data
 - backup destinations..... 204
 - enter..... 13
 - restore..... 204
 - scan to enter.....151
- data logs
 - about..... 15
 - automatic archiving.....202
 - export..... 202
 - format of exported.....202
 - overview..... 15
- decimal separator.....152
- derived parameters

- defaults..... 315
- definitions of acid-base.....316
- definitions of electrolyte.....319
- definitions of oximetry..... 317
- definitions of oxygen..... 317
- enable estimation..... 171
- estimated..... 314
- disinfecting
 - analyzer exterior..... 57
 - touch screen..... 57
 - when is it necessary?..... 56
- document
 - about this.....2
- documents.....3
- drift
 - definition..... 347

E

- electrolyte results
 - calculation..... 351
- electrolyte sensors
 - calculation of sensitivity.....351
 - construction..... 348
 - measuring principle.....349
 - status and sensitivity calibrations.....351
- environmental specifications..... 378
- equations
 - derived oxygen parameters..... 323
- Equations
 - derived acid-based parameters..... 320
 - derived electrolyte parameters.....322
 - derived oximetry parameters.....332
 - ODC.....335
 - units and symbols used..... 320
- external systems
 - interfacing with.....372
- external test results
 - comparison studies..... 287

F

- FCOHb
 - performance test results..... 232
 - traceability - 100 %..... 310
 - traceability - normal value.....309
- feedback messages..... 9
- FHbF
 - performance test results..... 235
 - limitation of use..... 2
 - traceability.....310
- FHHb
 - performance test results..... 234
- filtering

- QC results..... 81
 - activities..... 134
 - calibration results..... 90
 - patient results..... 30
 - fluid transport system
 - disinfect..... 57
 - flush..... 95
 - overview..... 342
 - FMetHb
 - performance test results..... 233
 - traceability..... 310
 - FO2Hb
 - performance test results..... 232
- G**
- glossary
 - QC terms..... 177
 - guided troubleshooting
 - about..... 93
- H**
- hazards..... 3
 - HbF corrections
 - enable..... 171
 - Hct
 - traceability..... 310
- I**
- icons
 - explanations..... 383
 - inlet clip
 - put on..... 58
 - remove..... 60
 - when is it necessary?..... 58
 - inlet connector gasket
 - replace..... 48
 - inlet gasket
 - clean..... 52
 - inlet gasket holder
 - replace..... 43
 - inlet module
 - clean..... 53
 - replace..... 50
 - inlet probe
 - replace..... 44
 - input parameters
 - acceptable values..... 313
 - defaults..... 315
 - definitions..... 313
 - intended use
 - analyzer..... 1
 - interference
 - electrolytes..... 243
 - HbF/HbA..... 365
 - metabolites..... 247
 - oximetry parameters..... 251
 - pH/blood gas..... 242
 - tests..... 242
 - intervention required mode
 - to get out of..... 93
- K**
- keyboard
 - connect non-USB external keyboard..... 60
 - connect USB keyboard..... 60
 - keyboard layout..... 152
- L**
- language
 - change..... 152
 - default setting..... 207
 - latest patient result
 - find..... 28
 - limitations of use..... 2
 - linearity studies
 - graphical presentation of results..... 237
 - linearity study
 - introduction..... 236
 - liquid sensor adjustment
 - request..... 98
 - LIS/HIS connection
 - set up..... 198
 - log
 - all measurement activities..... 153
 - log on..... 12
 - logoff time
 - set..... 147
 - logon
 - select logon procedure..... 144
 - long-term shutdown
 - to do..... 138
 - when to do..... 137
- M**
- mandatory and operator-defined activities
 - about..... 194
 - manual calibration
 - tHb calibration..... 85
 - max sample age..... 163
 - maximum sample age

set.....	162	operator action needed mode	
measured parameters		get out of.....	93
defaults.....	315	operator activities	
definitions.....	217	delete.....	196
measurement activities		operator activity	
log all.....	153	set up.....	196
measurement mode		operator requirements.....	2
remove.....	155	operators	
select a default.....	155	add.....	145
measurement principle.....	360	default.....	145
measurement principles		remove.....	146
potentiometric.....	349	operators and profiles	
measurement process.....	344	default settings.....	206
measurement units		optical system	
default settings.....	209	calibration.....	365
measurements and tests		construction.....	362
total number of.....	150	measuring principle.....	362
measuring principles		ordering information	
general introduction.....	341	power-supply cords.....	388
menu structure.....	14	sensor cassette.....	385
messages		solution pack.....	385
ampoule-based QC results.....	73	spare parts and accessories.....	385
calibration results.....	90	other activities	
patient results.....	30	schedule.....	195
shown on the analyzer screen.....	149	set up corrective action.....	195
types.....	9	out-of-range results	
metabolite results		suppress.....	170
calculation.....	359	oximetry parameters	
metabolite sensors		sensitivity calibration.....	85
calculation of sensitivity.....	359	oximetry results	
construction.....	358	calculation.....	367
measuring principle.....	360		
zero current.....	358		
miscellaneous setup			
default settings.....	213		
mode			
set up ampoule QC.....	156		
set up calibration verification.....	156		
set up proficiency test.....	158		
mouse			
connect non-USB mouse.....	60		
connect USB mouse.....	60		
my results			
find.....	28		
N			
network			
connect analyzer to.....	61		
note fields			
create standard texts.....	197		
delete standard texts.....	198		
edit standard texts.....	197		
O			
offset			
limits for offset value.....	173		
		P	
		parameter	
		enable/disable.....	169
		remove from a patient result.....	31
		symbols.....	313
		types.....	313
		parameter bar	
		hide.....	169
		show.....	169
		parameter tab colors.....	8
		parameters	
		default settings.....	209
		edit offset/slope.....	174
		input for derived electrolyte.....	319
		lock/unlock.....	149
		repress.....	170
		set up measurement units.....	170
		suppress out-of-range results.....	170
		patents.....	389
		patient data	
		automatic requests.....	199

- from LIS/HIS or AQUIRE/RADIANCE systems.....199
 - request automatically from LIS/HIS system..... 27
 - request using patient lookup)..... 199
 - request via patient lookup.....27
- patient identification
 - change report layout in.....27
 - edit data after measurement..... 28
 - screen.....26
- patient lookup
 - enable..... 199
- patient profile
 - add..... 148
 - delete.....148
 - edit..... 148
 - find..... 148
 - see data saved..... 148
- patient profiles log.....148
- patient report layout
 - edit..... 167
- patient report layouts
 - about..... 163
 - create..... 163
 - create extra items for layouts..... 166
 - select default.....166
- patient results
 - acid-base chart..... 30
 - add a note..... 31
 - approval and rejection.....32, 169
 - approve.....32
 - audit trail..... 31
 - change a layout for..... 165
 - enable approval/rejection.....169
 - filter data..... 30
 - find.....28
 - reject.....32
 - remove a parameter..... 31
 - see messages..... 30
 - show a parameter.....32
 - symbols..... 28
 - trends..... 31
- patient results log
 - status..... 29
- patient samples
 - storage recommendations..... 19
- patient/sample mix-up
 - reduce risk..... 20, 161
- pCO₂
 - measuring principle..... 353
 - performance test results 223–227, 229–234
 - traceability..... 308
- pCO₂ results
 - calculation..... 355
 - fix decimals in..... 170
- pCO₂ sensor
 - calculation of sensitivity..... 354
 - calibration.....354
 - construction..... 352
- performance characteristics
 - bias..... 219
 - coefficient of variation..... 220
 - confidence intervals.....220
 - overview.....218
 - repeatability.....219
 - reproducibility..... 219
 - test conditions.....221
 - total analytical error..... 220
 - uncertainty..... 218
- performance test results
 - cCa²⁺..... 226
 - cCl⁻..... 226
 - cGlu.....227
 - CK⁺..... 225
 - cLac.....229
 - cNa⁺.....225
 - ctHb.....230
 - FCOHb.....232
 - FHHb.....234
 - FMetHb.....233
 - FO₂Hb.....232
 - pH..... 223
 - pO₂..... 224
 - rounding rules..... 223
 - sO₂.....231
- pH
 - performance characteristics.....223
 - traceability..... 307
- pH results
 - calculation..... 351
- pH sensor
 - calculation of sensitivity..... 351
 - construction..... 348
 - measuring principle..... 349
 - status and sensitivity calibrations..... 351
- pO₂
 - calibration overview..... 356
 - measuring principle..... 355
 - performance test results..... 224
 - traceability..... 308
- pO₂ results
 - calculation..... 357
 - fix decimals in..... 170
- power-supply cords
 - product codes.....388
- precision
 - within ranges..... 372
- printed data
 - create a heading..... 151
- printer

edit name..... 201
 install..... 201
 printer paper
 protection of printed data..... 42
 replace..... 42
 printer setup
 default settings..... 214
 product codes
 sampling devices..... 387
 product specifications..... 376
 proficiency test
 set up mode..... 158
 proficiency test modes
 definition..... 157
 pump calibration
 request..... 98

Q

QA portal
 set up connection..... 200
 QC ID data
 edit..... 72
 QC management
 automatic..... 63
 by operators..... 67
 QC measurement
 edit schedule for ampoule-based..... 181
 QC measurements
 after replacement..... 184
 edit schedule for built-in..... 182
 schedule ampoule-based..... 181
 set up the temperature field..... 180
 status..... 63
 status symbols..... 63
 QC plot
 find..... 81
 QC plots..... 80
 QC products
 ordering information..... 386
 product codes..... 386
 QC results
 filter..... 81
 QC schedule
 link to the calibration schedule..... 176
 QC solution
 manually change control ranges..... 193
 register a non-Radiometer..... 179
 register a Radiometer..... 178
 QC solutions
 about registration..... 178
 ampoule-based QC..... 68
 analyze in other modes..... 82

data saved for registered non-
 Radiometer..... 180
 data saved in registered Radiometer..... 178
 enable use of fixed standard deviations..... 192
 why is registration necessary?..... 178
 QC statistics
 automatically print when lot numbers
 change..... 186
 find..... 79
 print..... 79
 set statistical factor..... 186
 QC terms..... 177
 quality control
 management..... 63
 terms..... 177

R

RADIANCE
 access from analyzer..... 200
 RADIANCE connection
 set up..... 198
 Radiometer QC ampoule
 prepare for use..... 69
 range
 of indication..... 161
 reference range for neo ctBil..... 159
 ranges and critical limits
 about..... 29, 158
 reference
 getting to know the analyzer..... 3, 61
 reference electrode
 construction..... 348
 purpose..... 347
 reference methods/materials..... 222
 reference ranges
 about..... 159
 set up..... 160
 references
 introduction..... 3, 61
 patient sample analysis chapter..... 34
 performance characteristics chapter..... 311
 principles of operation chapter..... 369
 setup chapter..... 215
 regional settings
 select..... 152
 repeatability..... 219
 replacement intervals
 recommended..... 35
 replacement setups
 default settings..... 211
 replacement warnings
 set up..... 197
 report layout
 edit..... 167

- reportable ranges
 - about..... 161
 - set up..... 161
 - reproducibility..... 219
 - restart
 - after a temporary shutdown..... 140
 - after long-term shutdown..... 141
 - restoring data
 - from backup..... 204
 - to Radiometer default settings..... 205
 - result messages
 - troubleshoot..... 30, 74, 90
 - RiLiBÄK rules
 - add..... 189
 - apply..... 190
 - edit..... 190
 - remove..... 191
 - rinse
 - process..... 344
 - request..... 98
- S**
- sample
 - mix on analyzer..... 19
 - pre-register..... 20
 - pre-registration..... 20, 161
 - to get a good..... 18
 - what is a good sample..... 18
 - sample age evaluation
 - about..... 162
 - sample analysis
 - capillary tube..... 22
 - syringes..... 21
 - test tube..... 24
 - sample counter
 - reset..... 150
 - screen explanation..... 150
 - see..... 150
 - sample pre-registration
 - interpret barcodes as..... 162
 - set up..... 162
 - sample type..... 319
 - sampling device
 - ordering information..... 387
 - product codes..... 387
 - saving changes..... 13
 - screen saver
 - enable..... 151
 - sensitivity
 - definition..... 345
 - sensor
 - general construction..... 341
 - sensor cassette
 - can it be used again?..... 41
 - effect of replacement on analysis time.... 40
 - export status logs..... 41
 - intended use..... 382
 - print status logs..... 41
 - product codes..... 385
 - replace..... 39
 - specifications..... 382
 - status of..... 39
 - sensor response stability
 - metabolite sensors..... 359
 - pCO₂ sensor..... 352, 355
 - pH and electrolytes sensor..... 352, 355
 - service..... 134
 - setup
 - load..... 205
 - menu structure..... 143
 - print setups..... 144
 - restore Radiometer default settings..... 205
 - save..... 205
 - setups
 - with no default setting..... 214
 - shutdown
 - do a long-term..... 138
 - temporary..... 137
 - slope
 - limits for slope value..... 173
 - slope and offset
 - apply corrections to QC results..... 185
 - sO₂
 - performance test results..... 231
 - sO₂ = 0%
 - traceability..... 309
 - sO₂ = 100 %
 - traceability..... 309
 - software version..... 135
 - solution pack
 - can it be used again?..... 38
 - export status logs..... 39
 - print status logs..... 39
 - product codes..... 385
 - release manually..... 38
 - replace..... 36
 - specifications..... 380
 - status of..... 36
 - use of..... 380
 - specifications
 - environmental..... 378
 - measured blood parameters..... 371
 - power-supply cords..... 380
 - product..... 376
 - start screen
 - about..... 9
 - quick access..... 9
 - statistical factor..... 186

status		
definition.....	347	
storing the analyzer.....	140	
symbols		
ampoule-based QC results.....	73	
built-in QC results.....	66	
explanation.....	383	
on calibration-verification results.....	78	
syringe modes		
create new.....	154	
edit.....	153	
select a specific report layout.....	156	
system checks.....	64	
system messages		
set up corrective actions.....	150	
T		
temperature		
automatically change unit.....	167	
temporary shutdown		
to do.....	137	
when to do.....	137	
test conditions.....	221	
text		
enter.....	13	
tHb calibration		
do.....	87	
thousands separator.....	152	
time and data formats.....	152	
time and date		
set.....	151	
total analytical error.....	220	
touch screen		
clean.....	56	
disinfect.....	57	
trends		
calibration results.....	91	
in patient results.....	31	
QC results.....	81	
troubleshoot		
messages in the Analyzer status		
screen.....	11, 94	
troubleshooting		
when is it necessary?.....	93	
troubleshooting modes		
causes.....	93	
troubleshooting needed mode		
get out of.....	93	
tubing refill		
request.....	98	
U		
uncertainty		
convert to another confidence level.....	219	
performance characteristics.....	218	
units		
set up.....	170	
user-defined corrections		
apply to QC results.....	185	
edit.....	174	
offset and slope.....	172	
user-defined patient data items		
default settings.....	212	
W		
warnings		
definition.....	3	
general.....	17	
WDC		
about.....	81	
export file.....	82	
Westgard rules		
description and corrective action.....	187	
disable/enable.....	189	
line descriptions.....	186	
set up and enable.....	188	
types.....	186	

If you have any questions or need assistance, please contact your local Radiometer representative.

Radiometer representative:

Code number: 996-189
Version: 201602A

IVD



Radiometer Medical ApS
Åkandevej 21
2700 Brønshøj
Denmark
<http://www.radiometer.com>